



# Catalog 2018

Liquid Handling, Sample Handling, Cell Handling



# Have a Nize Day!

## VisioNize® – The Connected Lab System

The VisioNize system allows you to easily link your lab equipment to a central monitoring and data management software. It's a smart network that lets you manage your lab equipment efficiently whenever you want and wherever you are. Simply scan the QR code and visit our continuously updated website:

[www.eppendorf.com/visionize](http://www.eppendorf.com/visionize) or see page 12-13 for further information.



# Dear customers,

As a leading company in the life sciences sector we would like to welcome you to our world of products. In addition to our classic range of products, our new 2018 catalog features a series of high-quality, innovative products and technologies.

To name just a few; the new centrifuges 5425 and 5910 R and the associated rotors. Or our latest VisioNize software innovation for networking a range of Eppendorf products such as ULT freezers, cyclers and shakers. An overview of all the innovations can be found on pages 6 - 9. We wish you an enjoyable read!

As you can see, we at Eppendorf are remaining true to our goal of making laboratory processes safer, more precise, simpler and faster. We maintain close contact with research institutions and laboratories around the world in order to achieve this goal together. For our development department the needs of our customers are both a challenge and an incentive. Our customer service does not end with the delivery of the product.

We also offer an extensive range of other services related to our products through our webinars, epServices and liquid, sample and cell handling solutions. Read more on pages 352-386 or visit our website [www.eppendorf.com/handling-solutions](http://www.eppendorf.com/handling-solutions).

The Management Board of the Eppendorf Group

Thomas Bachmann

Detmar Ammermann

Eva van Pelt

Dr. Wilhelm Plüster

# Table of Contents



## LIQUID HANDLING 16-85

- > Pipettes 24-34, 64
- > Pipette tips, Combitips, ViscoTip 38-55, 60-63
- > Dispensers 56-59
- > Pipette controller, pipette helper 64-65, 67
- > Serological pipettes 66
- > Bottle Top dispenser 68-71
- > Automated pipetting systems 72-85



## epServices 352-386

- > Trainings 354-355
- > Technical Support 356-357
- > Performance Plans Liquid Handling 358-365
- > Performance Plans Sample Handling 366-375
- > Performance Plans Cell Handling 376-385
- > Performance Plans Bioprocessing 386



## SAMPLE HANDLING 86-267

- > Mixers and temperature control systems 86-101
- > Reaction tubes, plates, storage boxes and racks 102-121
- > Centrifuges and rotors 122-210
- > Concentrators 211-213
- > Photometry and Detection 214-227
- > PCR thermocyclers and consumables 228-245
- > Freezers 246-267



## EU-IVD and EU-MD Products 387-418

- > Liquid Handling 392-401
- > Sample Handling 402-413
- > Cell Handling 414-417



## CELL HANDLING 268-331

- > Micromanipulation 268-287
- > Cell Culture and Cell Imaging Consumables 288-297
- > CO<sub>2</sub> Incubators 298-309
- > Shakers 310-331
- > Bioprocessing 334-351

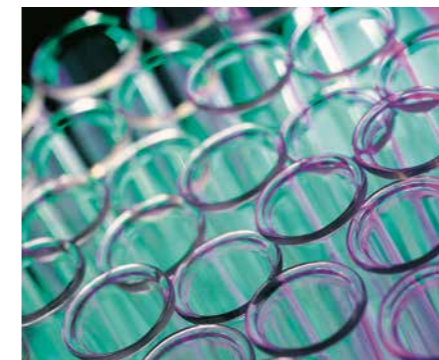

## INDEX 419-465

- > Alphabetical Index 419-424
- > Index of order numbers 425-433
- > Different mains voltage versions 434-443
- > Your local contact 444-457
- > Legal notices, trademarks, patent and design attributions 452-457



## OEM/CUSTOMIZED SOLUTIONS 332-333

- Eppendorfs modification portfolio
- > OEM Products
  - > Customized Consumables
  - > Customized Instruments
  - > Customized Logistics and packaging
- (for further information please visit [www.eppendorf.com/OEM](http://www.eppendorf.com/OEM))

# New Highlights 2018

## LIQUID HANDLING



### Eppendorf Varispenser 2/2x - see page 86

The new Varispenser 2/2x bottle top dispensers show top performance from the bottom to the top. Made for laboratory tasks with aliquots of aggressive solution like lyes, acids, solutions or bases taken from large supply bottles, these instruments can ease routine applications using the trusted PFA sealing lip technology.

With this technology crystal building from media residue is avoided by wiping of the inner cylinder wall during dispensing. The high chemical resistance of these bottle top dispensers and several optimizations of design elements and technical details will make this instrument indispensable in your laboratory.

## LIQUID HANDLING



### Eppendorf ViscoTip™ - see page 60

Experience the new member of the Combitips advanced® dispenser tip family. The ViscoTip is specifically designed and optimized for handling high viscosity liquids up to 14,000 mPa\*s such as Glycerol 99.5%, Tween, oils, cremes, shampoos or honey.

The ViscoTip significantly reduces operating forces while handling such liquids. This enhances ergonomics, increases working speed and prolongs charge life time of your Multipipette battery.

## LIQUID HANDLING



### Eppendorf Pipette Holder System - see page 34

Carousels, stands and wall mount devices: The new Pipette Holder System is perfect for all users of handheld liquid handling instruments, who need a highly flexible system for their Eppendorf pipettes and Multipipettes.

Carousels and stands provide a robust design with a small footprint. To save precious bench-top space carousels carry both manual and electronic instruments. And only Eppendorf offers a charger carousel with intelligent charging electronics that carries up to 6 instruments.

## SAMPLE HANDLING



### Eppendorf Tube Racks and Cuvette Racks - see page 121

Optimize your workflows through user-friendly handling of clearly arranged samples. Almost all laboratory protocols require efficient and reliable processing, transport, and short term storage of sample vessels in benchtop racks.

The new Eppendorf Cuvette Racks combine optimized functionality and high robustness with an attractive design.

Six different formats offer the optimal solution and perfect fit for all tubes and cuvettes commonly used in laboratories. Compact dimensions require minimal space.

## SAMPLE HANDLING



### Eppendorf Centrifuge 5425 - see page 129

The new air-cooled Centrifuge 5425 covers a range of very frequent applications and thus is an essential piece of equipment for modern labs.

It replaces an Eppendorf success story, the Centrifuge 5424, to become the new laboratory standard.

Developed with a high sense of customer orientation, it provides a top level of ergonomic comfort as well as great flexibility with its 6 rotor options. Especially the availability of a 5.0 mL rotor for the Centrifuge 5425 makes sure that there will be even more opportunities to use and spin the popular Eppendorf Tubes® 5.0 mL.

## SAMPLE HANDLING



### Eppendorf Centrifuge 5910 R - see page 176

The new refrigerated Centrifuge 5910 R combines high capacity and performance in a compact and ergonomic product design.

It shares the modern user interface and the advanced temperature management system of its bigger brother, the Centrifuge 5920 R, which lab users have come to love<sup>1)</sup>.

<sup>1)</sup> Centrifuge 5920 R was in 2017 voted Best New General Lab Product by scientists around the world on Select Science.

# New Highlights 2018

## SAMPLE HANDLING



### Eppendorf Mastercycler® X50 Family - see page 230

The creators of gradient technology is proud to present the Next Stage of PCR optimization. In addition to optimizing the annealing temperature using a traditional gradient, the Mastercycler X50 allows you to optimize a second step, e.g denaturation temperature - in the same run. Increased block control means we can do this whilst achieving unrivalled ramp rates - 10°C/s. You can connect up-to x10 cyclers into a network, the highly responsive touch screen interface makes programming extremely quick and simple. In addition the Mastercycler X50 has maintained some traits of its predecessors – very low noise levels, very low power consumption, a footprint that uses a minimal width of bench-space and we have maintained an 'open system' that can accommodate consumables from single PCR tubes to fully skirted PCR plates.

In designing the Mastercycler X50 family, we have engineered beyond common conventional barriers. Let's address your PCR bottlenecks!

## SAMPLE HANDLING



### Eppendorf CryoCube® F740 series - see page 252

The CryoCube F740 ULT Freezer is the latest addition to the Eppendorf Freezer Family. Combining the high-quality tradition of our previous freezers with an increased capacity, the CryoCube F740 is designed to store more of your samples securely while maintaining optimal energy usage. The integration of the PhysioCare Concept® during development means that the CryoCube F740 is easier and more comfortable to use, reduces user stress, supports an ergonomic workspace, and provides optimal workflow in the lab.

## CELL HANDLING



### Eppendorf CellTram® 4r Air/Oil - see page 276

Working with the new generation of CellTrams is like taking a breath of fresh air. Our new manual microinjectors have been designed with special emphasis on excellent ergonomics, ease of use and highest precision.

The CellTram 4r Air is a pneumatic microinjector for oil-free microinjection and gentle holding of cells in suspension. Due to its improved pressure control system the new CellTram 4m Air is also suitable for oil-free uptake and injection of cells (e.g. sperm, ES cells).

## CELL HANDLING



### Eppendorf Innova® S44i Biological Shaker – see page 318

Eppendorf is bringing the latest innovations in shaker technology to the market with the new Innova S44i - a large capacity, stackable shaker with temperature control functionality. It is designed to provide maximum flask and weight capacity at a very compact footprint. The proprietary Eppendorf X-Drive combines real time sensing of imbalances and semi-automated adjustment of counterweights for reliable shaking performance.

Intuitive touchscreen user interface with restrictive user access, and Ethernet port for integration to external networks make this the ideal shaker for sophisticated laboratories. The precise and uniform environment in the chamber results in high yields and reproducible results across the platform.

# Are you looking for more Details?

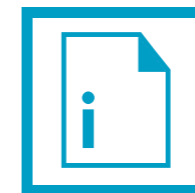

White Papers



Application Notes



Graphics

Do you miss further information or simply wish additional details?

On our catalog pages you will find QR codes with icons showing you what kind of marketing materials (brochure, website, 360 degree views and much more) we offer for viewing or downloading.

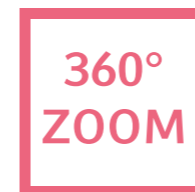

3-D Views



Brochures

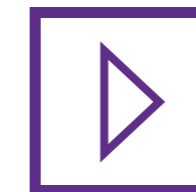

Videos



Websites

Simply scan the QR Code on the corresponding pages and make use of our online offers.

# The Eppendorf Knowledge Base

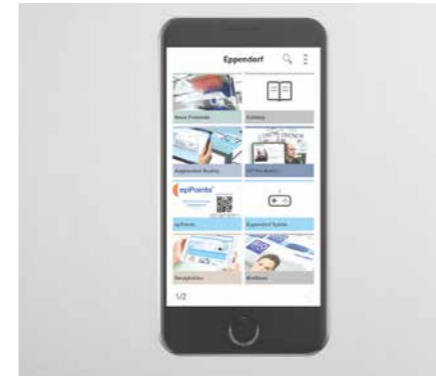

Mobile App



Magazines



Notes and Papers

The needs of our customers are more than ever the focus of our actions. Our aim has always been to anticipate the requirements of tomorrow and to meet these needs without compromise.

In addition to our products, we therefore offer a lot of information for optimizing your daily work routines. For example, online operating manuals, customer magazines, mobile apps or the Eppendorf media library.

**Visit the Eppendorf Knowledge Base!**



[www.eppendorf.com/knowledge-base](http://www.eppendorf.com/knowledge-base)



Manuals



Brochures and Flyers



Catalog



FAQs





Software Downloads



Mediathek

# VisioNize® – The Connected Lab System

Imagine you could use a smart network in your lab to organize your lab equipment efficiently anytime and anywhere with a single glance. Now you can – with Eppendorf VisioNize. Connect your lab equipment to VisioNize core and remotely monitor the performance from your office PC or with the mobile app VisioNize go. The Eppendorf VisioNize system basically consists of these two software components and the VisioNize box, an easy-to-use hardware integration interface to connect selected devices. Connectable devices are Eppendorf VisioNize-qualified devices that have to be connected via VisioNize box, and VisioNize-onboard devices that are already equipped with VisioNize functionalities and can be connected directly. Further lab devices can be added manually to VisioNize core with limited functionalities. That builds up a smart network for your lab organization.

		
<p><b>Monitor</b></p>	<p><b>Check</b></p>	<p><b>Enable</b></p>
<p><b>The PC Software to manage and monitor your lab equipment</b></p> <ul style="list-style-type: none"> <li>&gt; Get a 24/7 tracking report with detailed trends and event information</li> <li>&gt; Receive information about alarms via e-mail notification</li> <li>&gt; Use a central database, e.g. for documents and service information</li> </ul>	<p><b>The free mobile app for iOS® devices</b></p> <ul style="list-style-type: none"> <li>&gt; Monitor your instruments at any time</li> <li>&gt; See what's going on in the lab, wherever you are</li> </ul>	<p><b>The easy-to-install hardware hub</b></p> <ul style="list-style-type: none"> <li>&gt; Connect your already installed freezers</li> <li>&gt; Manage further devices in your existing workflow</li> </ul>

VisioNize core is the central data server in the VisioNize system. It's connected to the lab instruments over your local network. All relevant device information and documents are stored on this data server, which is centrally installed (on premises) in your institution. Device information are routed through your local network infrastructure and safely archived in VisioNize core. The mobile iOS app VisioNize go allows you to check the current status of your devices when you have left your lab or institution. This feature displays such relevant parameters as temperature and remaining runtime so you can efficiently organize your daily lab routine even if you are not in the lab. That gives you peace of mind, especially for overnight processes. With VisioNize box you can connect Eppendorf VisioNize-qualified devices to the VisioNize system. The hub works as a data-decoding and translation system and lets you collect device data in VisioNize core. Many of the Eppendorf devices you may have already installed can be upgraded to a connectable instrument and then displayed and monitored using VisioNize core and VisioNize go.

# Labwork meets Network

The VisioNize system allows you to easily link your lab equipment to a central monitoring and data management software. It's a smart network that lets you monitor your lab equipment efficiently whenever you want and wherever you are. The new interface design of different components of the VisioNize system provides an excellent user experience and simplifies operation. If you're already familiar with using a component or instrument in the VisioNize system, you'll also find other instruments and components intuitive to operate because the user experience is consistent across product lines and platforms (PC software, mobile app and device display). Experience the new VisioNize user interface concept across the touch interfaces of VisioNize-onboard devices as well as in the software applications VisioNize core and VisioNize go.

Consistent operation across product lines

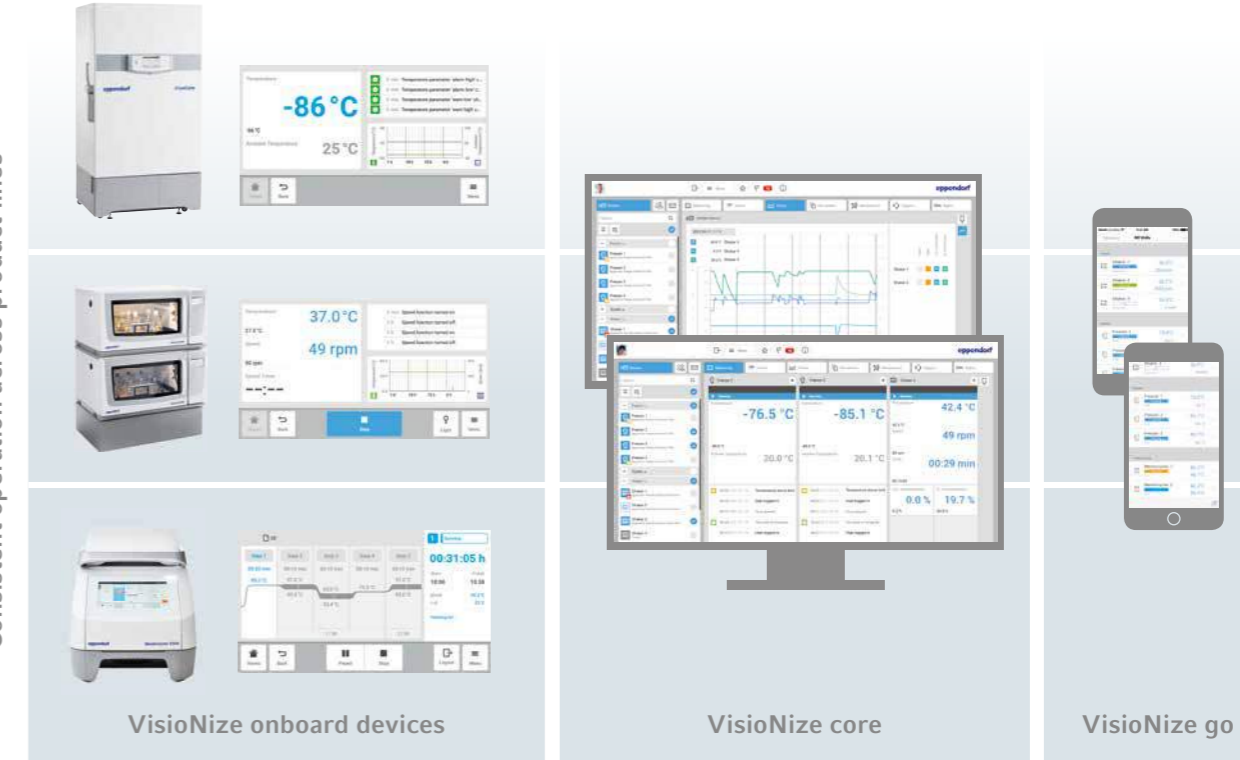

Consistent operation across platforms



At the following pages you can identify connectable Eppendorf devices by this icon VisioNize: 230, 252 and 318

# Pure Quality

## Eppendorf purity grades for consumables

Eppendorf consumables stand for the highest quality and purity achieved by:

- > using pure raw materials
- > automatic production in clean room conditions
- > quality and functional checks of all lots
- > continuous quality assurance throughout the entire production process

With the strictest control criteria, internally and externally monitored, we guarantee consistently high quality of our products – lot by lot. Our consumables are available in different purity grades for individual application demands: “Eppendorf Quality™” as well as advanced purity grades like “sterile”, “protein-free”, “PCR clean”, „Forensic DNA Grade (acc. to ISO 18385)”, and “Biopur®”. In addition to our internal process controls, and general quality certificates, lot-specific certificates are provided by an external test laboratory for the advanced purity grades. This allows us to consistently meet our customer’s high demands when it comes to the high quality and purity of our products. As a special service, our lot-specific certificates are available on request and on our website ([www.eppendorf.com/certificates](http://www.eppendorf.com/certificates)).

## The basis: Top-quality material

- > All plastics used by Eppendorf to produce consumables comply with international purity criteria.
- > The dyes used to color consumables are free of organic substances and substances containing heavy metals.
- > Plastics, such as polypropylene, have a high chemical resistance to organic and inorganic acids/ bases and organic solvents commonly used in laboratories.

## Eppendorf Quality™:

Products with the purity grade “Eppendorf Quality” are ideal for many tasks in the lab. To meet consistently our customer’s high demands on quality further measurements are performed specifically for individual product groups:

- > Precise molding guarantees high precision and accuracy. Each lot of tips is subject to gravimetric measurement during final testing. Low wetting ensures reliable volume readings and minimal adhesion.
- > Eppendorf Tubes® have to be opened and closed by one hand only; without sample material being contaminated. They are highly stable, even when exposed to extreme mechanical or thermal strain. Therefore, on a daily basis we check vapor

tightness, lid-opening force, wall strength, force required to pierce the lid as well as resistance to centrifugation.

- > We check high resistance to centrifugation and sealability of deepwell plates and microplates.
- > All production tools are subject to frequent checks at regular intervals in order to guarantee consistent quality throughout the entire production period.

## Eppendorf Protein-free:

Eppendorf consumables with this purity grade are free of proteins and thus free of unspecific signals or reactions due to protein contamination.

A colorimetric assay which can detect down to 1ng/μL is used for testing and detecting protein contamination. Lot-specific certificates provided by an external accredited laboratory are available on request and on our website. Furthermore, all Eppendorf protein-free products fulfill the quality standards defined for our purity grade “Eppendorf Quality”.

## Eppendorf Sterile:

Besides fulfilling the quality criteria of “Eppendorf Quality” Eppendorf consumables with the purity grade “sterile” are sterilized

and free of pyrogens. Each lot is certified by an external accredited laboratory. Eppendorf sterile consumables are sterilized in accordance with ISO 11137 or ISO 11135. A quality seal which assures customers of the suitability of their Eppendorf consumables for direct use in experiments and analysis without the need for further treatment. Lot-specific certificates are available on request and on our website.

## Eppendorf PCR clean:

All Eppendorf consumables with the purity grade “PCR clean” ensure not to interfere with the PCR. Furthermore, all Eppendorf PCR clean products fulfill the quality criteria defined for our standard consumables (purity grade “Eppendorf Quality”). The purity grade “PCR clean” is essentially achieved in not even letting contamination develop. Therefore, the corresponding plastic items are manufactured comparable to clean-room conditions. The manufacturing areas are spatially separated and only personnel in special protective clothing are granted access. Lot-specific certificates provided by an external accredited laboratory confirm the compliance with the criteria DNase-, RNase-, PCR inhibitor-, and human DNA-free. The certificates are available on request and on

our website. “PCR clean” – a quality seal which assures customers of the suitability of their Eppendorf consumables for direct use in experiments and analysis.

## Eppendorf Forensic DNA Grade (acc. to ISO 18385):

Human DNA contamination is one of the main concerns in forensic DNA analysis. The ISO 18385 has been implemented to further minimize the risk of DNA contamination. This standard specifies requirements for manufacturing products used in the collection, storage and analysis of biological material for forensic purposes. Highly automated production lines and stringent access controls are only two production conditions for “Eppendorf Forensic DNA Grade” consumables which contribute in fulfilling ISO 18385.

Individually blistered packaging or “mini batches” in re-sealable bags provide effective protection against contamination. Lot-specific certificates provided by an external accredited laboratory confirm the compliance with the criteria DNase-, RNase-, PCR inhibitor-, and human DNA-free. The certificates are available on request and on our website.

## Eppendorf Biopur®:

To meet the highest demands of the clinical, pharmaceutical, cosmetic, food industries and others, the quality and purity grade “Biopur” was defined. This purity is ensured by an elaborate, automated manufacturing process which safeguards the product against contamination with biological substances. Furthermore, all “Biopur” products fulfill the quality standards defined for our standard consumables (Purity grade “Eppendorf Quality”).

Lot-specific certificates provided by an external accredited laboratory confirm the compliance with the criteria sterile, DNase-, RNase-, PCR inhibitor, ATP-, Pyrogen-, human and bacterial DNA-free. The certificates are available on request and on our website. “Biopur” – a quality seal which assures customers of the suitability of their Eppendorf consumables for direct use in experiments and analysis.

For further details please read page 36-37 and 102.



The Eppendorf purity grade “Eppendorf Quality” fulfill everything expected of reliable, easy-to-handle consumables. With the aid of high-quality base material and permanent checks during production, Eppendorf consumables in Eppendorf Quality are ideal for many tasks in the lab.

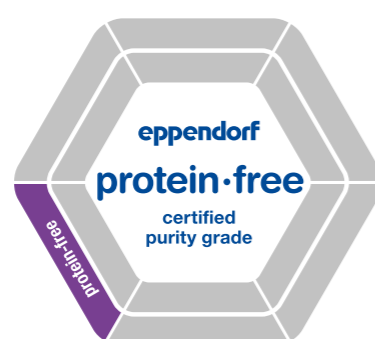

Eppendorf consumables with this purity grade are free of proteins and thus free of unspecific signals or reactions due to protein contamination.



Eppendorf consumables with the purity grade “Sterile” are sterilized in accordance with ISO 11137 or ISO 11135 with a Sterility Assurance Level (SAL) of 10<sup>-6</sup>. Lot-specific certificates document sterility and the absence of endotoxins in accordance with Ph. Eur. 2.6.14.

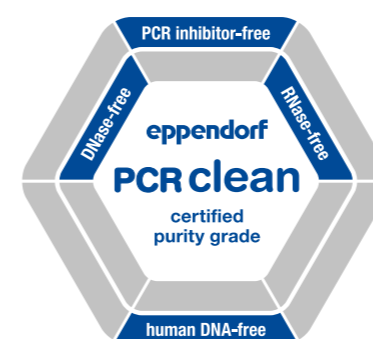

All Eppendorf consumables with the purity grade “PCR clean” are DNase- and RNase-free, and free of PCR-inhibitors. It is also guaranteed that the consumables are free of contaminating human DNA.

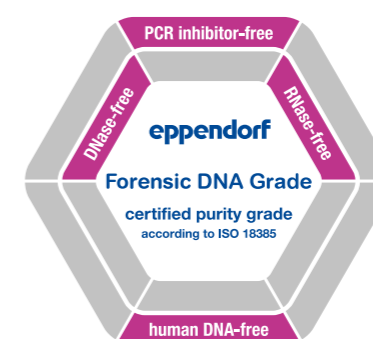

The demanding requirements of the ISO 18385 are fulfilled by “Eppendorf Forensic DNA Grade” consumables. These products help to further minimize the risk of human DNA contamination in forensic DNA analysis. Individually blistered packaging or “mini batches” in re-sealable bags also help to protect against contamination.

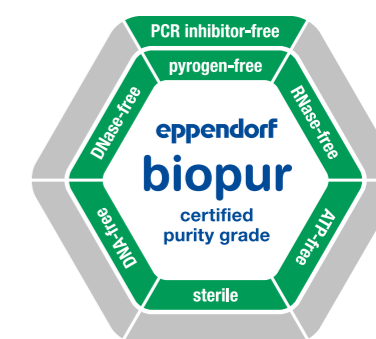

Consumables available in this highest possible degree of Eppendorf purity grades are guaranteed to be sterile and free of pyrogens, RNases, DNases, DNA and ATP as well as PCR inhibitors. Individually blistered or “mini batches” in re-sealable boxes provide effective protection against soiling and contamination.



# Liquid Handling



Model	Eppendorf Research® plus	Eppendorf Reference® 2	Eppendorf Xplorer®/Xplorer plus
Page(s)	24	28	31
Product type	Pipette	Pipette	Pipette
Operating mode	Manual	Manual	Electronic
Pipetting type	Air-cushion	Air-cushion	Air-cushion
Positioning	Ultra light weight and pipetting forces for advanced ergonomics	Reliability in robustness and results	Intuitive and fast pipetting
Application	Pipetting of aqueous liquids, two-button operation	Pipetting of aqueous liquids, single-button operation	Pipetting of aqueous liquids
Volume range	0.1 µL – 10 mL	0.1 µL – 10 mL	0.5 µL – 10 mL
Available options	1-channel 8-channel 12-channel	1-channel 8-channel 12-channel	1-channel 8-channel 12-channel
RFID tracking	Yes (read option)	Yes (read and write option)	Yes (read and write option)
Autoclavable	Yes	Yes	Yes (lower part)
Consumables	epT.I.P.S.® and other pipette tips	epT.I.P.S.® and other pipette tips	epT.I.P.S.® and other pipette tips
Purity grades of consumables	> Eppendorf Quality™ > PCR clean and sterile > Eppendorf Biopur® > Forensic DNA Grade	> Eppendorf Quality™ > PCR clean and sterile > Eppendorf Biopur® > Forensic DNA Grade	> Eppendorf Quality™ > PCR clean and sterile > Eppendorf Biopur® > Forensic DNA Grade



Model	epT.I.P.S./epT.I.P.S.® Long	ep Dualfilter T.I.P.S./ ep Dualfilter T.I.P.S. SealMax
Page(s)	38/41	42/43
Applications	> Pipetting liquids > Dispensing liquids > Mixing liquids > Filling plates and reaction vessels > Filling gels for electrophoresis > Phase extraction and removal of supernatants	> DNA applications (e.g. PCR) > RNA applications (e.g. Gene expression analysis) > Protein applications (e.g. Antibody Research) > Cell Culture applications (e.g. Media) > Applications with radio actives > All applications which use aerosol <sup>1)</sup> binding liquids

<sup>1)</sup> An aerosol is a colloid of fine solid particles or liquid droplets, in air or another gas.



Model	Varipette®	Multipette® M4	Multipette® E3/E3x
Page(s)	64	56	58
Product type	Pipette	Dispenser	Dispenser
Operating mode	Manual	Manual	Electronic
Positive displacement	Yes	Yes	Yes
Positioning	Fault tolerant pipetting of small/large volumes, independent of external effects	Time saving by acceleration of long pipetting series with low outside fault effects	Time saving by acceleration of long pipetting series, with highest volume flexibility and lowest outside fault effects
Application	Contamination-free pipetting of aqueous, viscous and volatile liquids	Contamination-free dispensing (up to 100 steps per Combitip filling) of aqueous, solutions and problem liquids (e.g., viscous, volatile, dense...)	Contamination-free dispensing (up to 100 steps per Combitip filling) of aqueous, solutions and problem liquids (e.g., viscous, volatile, dense...)
Volume range	1 – 10 mL	1 µL – 10 mL	1 µL – 50 mL
Available options	1-channel	1-channel	1-channel
RFID tracking	No	Yes (read option)	Yes (read and write option)
Autoclavable	No	No	No
Consumables	Varitips	Combitips advanced® ViscoTip (Eppendorf Quality™ only)	Combitips advanced® ViscoTip (Eppendorf Quality™ only)
Purity grades of consumables	> Eppendorf Quality™	> Eppendorf Quality™ > PCR clean > Eppendorf Biopur® > Forensic DNA Grade	> Eppendorf Quality™ > PCR clean > Eppendorf Biopur® > Forensic DNA Grade

**epServices**  
for premium performance

On page 358 you will find detailed information on services for these products!



Model	epT.I.P.S.® LoRetention/ ep Dualfilter T.I.P.S.® LoRetention	GELoader®	Microloader™
Page(s)	44	40	40
Applications	> Cell culture (media) > Genomics: PCR, RT-PCR, qPCR and all other types of PCR > Enzymatic reactions (restriction decomposition, ligation) > Isolation and purification of nucleic acid > Gel electrophoresis (e.g., prefabricated DNA ladders) typical detergents: SDS, Triton®, X-100, Brij® 35, Tween® 20, CHAPS > Proteomics (all types of protein examinations) > Protein isolation and purification	> Gel electrophoresis > Loading of samples onto polyacrylamide gels > Handling of smallest volumes	> Filling of microcapillaries for microinjection > Recovery of excess solution from the capillary > Pipetting smallest volumes where additional reach is needed



<b>Model</b>	Varispenser® 2/Varispenser® 2x
<b>Page(s)</b>	68
<b>Product type</b>	Bottletop dispenser
<b>Operating mode</b>	Manual
<b>Pipetting type</b>	Positive displacement
<b>Positioning</b>	Varispenser 2 and 2x bottletop dispensers combine trusted technology with improved benefits for safe and easy dispensing of liquids without compromise
<b>Application</b>	Single stroke dispensing of lyes, acids, bases, aqueous liquids or solvents
<b>Volume range</b>	0.2 – 100 mL
<b>Available options</b>	1-channel
<b>RFID tracking</b>	No
<b>Autoclavable</b>	Yes
<b>Consumables</b>	–
<b>Purity grades of consumables</b>	–



<b>Model</b>	Eppendorf Top Buret™
<b>Page(s)</b>	70
<b>Product type</b>	Bottletop burette
<b>Operating mode</b>	Manual
<b>Pipetting type</b>	Positive displacement
<b>Positioning</b>	Continuously and puls-free manual titration
<b>Application</b>	Titration of aqueous liquids
<b>Volume range</b>	0.1 – 999.9 mL
<b>Available options</b>	1-channel
<b>RFID tracking</b>	No
<b>Autoclavable</b>	No
<b>Consumables</b>	–
<b>Purity grades of consumables</b>	–



<b>Model</b>	Combitips advanced®	Varitips®
<b>Page(s)</b>	61	64
<b>Applications</b>	<ul style="list-style-type: none"> <li>&gt; Positive displacement principle (comparable to a syringe)</li> <li>&gt; High-precision dispensing regardless of the physical properties of the liquid (e.g., viscosity, volatility, density, temperature...)</li> <li>&gt; Prevents aerosol contamination with hermetically sealed piston for secure dispensing</li> <li>&gt; Provides protection from radioactive and toxic substances</li> <li>&gt; Quick dispensing of long series with precise, repeated dispensing of identical volumes (with Multipipette hand dispensers)</li> </ul>	<ul style="list-style-type: none"> <li>&gt; Pipetting aqueous solutions</li> <li>&gt; Extraction of liquids from deep receptacles</li> <li>&gt; Transfer of organic liquids (alcohols, org. acids etc.)</li> <li>&gt; Transfer of solvents with high vapor pressure (e.g. diethyl ether)</li> <li>&gt; Transfer of liquids with high density</li> <li>&gt; Transfer of viscous liquids</li> </ul>



<b>Model</b>	Eppendorf Easypet® 3
<b>Page(s)</b>	65
<b>Product type</b>	Pipette controller
<b>Operating mode</b>	Electronic
<b>Pipetting type</b>	Air-cushion
<b>Positioning</b>	Overall ergonomic concept with new speed control for stress-free pipetting
<b>Application</b>	Pipetting of aqueous liquids with serological and volumetric pipettes
<b>Volume range</b>	0.1 – 100 mL
<b>Available options</b>	1-channel
<b>RFID tracking</b>	Yes (read option)
<b>Autoclavable</b>	No (yes: pipette adapter and aspirating cone)
<b>Consumables</b>	Eppendorf Serological Pipettes and other volumetric and serological pipettes
<b>Purity grades of consumables</b>	<ul style="list-style-type: none"> <li>&gt; Sterile, pyrogen-, DNase-, RNase-, human and bacterial DNA-free. Non-cytotoxic.</li> </ul>



<b>Model</b>	Eppendorf Pipet Helper®
<b>Page(s)</b>	67
<b>Product type</b>	Pipette controller
<b>Operating mode</b>	Manual
<b>Pipetting type</b>	Air-cushion
<b>Positioning</b>	A perfect instrument for inexperienced users because of its robust and intuitive design
<b>Application</b>	Pipetting of aqueous liquids with serological and volumetric pipettes
<b>Volume range</b>	0.1 – 100 mL
<b>Available options</b>	1-channel
<b>RFID tracking</b>	No
<b>Autoclavable</b>	Yes
<b>Consumables</b>	Eppendorf Serological Pipettes and other volumetric and serological pipettes
<b>Purity grades of consumables</b>	<ul style="list-style-type: none"> <li>&gt; Sterile, pyrogen-, DNase-, RNase-, human and bacterial DNA-free. Non-cytotoxic.</li> </ul>



<b>Model</b>	epMotion® 96/epMotion® 96xl with 2-position slider
<b>Page(s)</b>	72
<b>Product type</b>	Semi-automated Pipette
<b>Operating mode</b>	Electronic
<b>Pipetting type</b>	Air-cushion
<b>Positioning</b>	Intuitive and fast pipetting in 96 and 384 format
<b>Application</b>	Pipetting of aqueous liquids
<b>Volume range</b>	0.5 – 300 µL/5 – 1,000 µL
<b>Available options</b>	96-channel
<b>RFID tracking</b>	No
<b>Autoclavable</b>	No
<b>Consumables</b>	epT.I.P.S.® motion reload system
<b>Purity grades of consumables</b>	<ul style="list-style-type: none"> <li>&gt; Eppendorf Quality™</li> <li>&gt; PCR clean</li> <li>&gt; PCR clean and sterile</li> </ul>



On page 358 you will find detailed information on services for these products!



Model	epMotion® 5070	epMotion® 5070f
Page(s)	74	74
Dimensions (W x D x H)	65 x 48 x 63 cm / 26 x 19 x 25 in	65 x 48 x 63 cm / 26 x 19 x 25 in
Weight w/o accessories	45 kg	33 kg
Max. power consumption	150 W	150 W
Power supply	100 – 240 V ±10 %, 50 – 60 Hz ±5 %	100 – 240 V ±10 %, 50 – 60 Hz ±5 %
Optical confocal infrared detector	Contact-free recognition of fill level, inserted tools, labware, tip types and quantities	Contact-free recognition of fill level, inserted tools, labware, tip types and quantities
SLAS/ANSI positions	4	4
Volume range	0.2 µL – 1 mL	0.2 µL – 1 mL
Random measurement error	±0.1 mm	±0.1 mm
Systematic measurement error	±0.3 mm	±0.3 mm
Dispensing tool <sup>1)2)</sup>		
Random measurement error (1 µL)	≤3 %	≤3 %
Systematic measurement error (1 µL)	±5 %	±5 %
Random measurement error (50 µL)	≤0.4 %	≤0.4 %
Systematic measurement error (50 µL)	±1.2 %	±1.2 %
Random measurement error (1,000 µL)	≤0.15 %	≤0.15 %
Systematic measurement error (1,000 µL)	±0.7 %	±0.7 %
Pipetting type	Air-cushion	Air-cushion
Gripper option	no	no
Thermal module(s)	no	no
Thermal module (optional)		
Cooling rate	–	–
Heating rate	–	–
ThermoMixer upgrade option	no	no
ThermoMixer		
Max. load	–	–
Mixing period	–	–
Speed	–	–
Temperature range	–	–
Vacuum unit		
Vacuum max. output	–	–
Underground area	–	–
Suction time	–	–
Magnetic separation	no	no
Vacuum separation	no	no
Automatic tool exchange	2 tools	2 tools
UV/HEPA option	no	no
MagSep reagents for DNA/RNA purification	–	–
For operation in biosafety cabinet	–	yes

<sup>1)</sup> in pipetting mode, free jet, without pre-wetting, with distilled water, at 20 °C <sup>2)</sup> See Eppendorf Application Note 168 for typical pipetting performance

i For more information go to [www.eppendorf.com](http://www.eppendorf.com)

Technical specifications subject to change.



Model	epMotion® 5073i	epMotion® 5073m
Page(s)	75	75
Dimensions (W x D x H)	65 x 61 x 67 cm / 26 x 24 x 27 in	65 x 61 x 67 cm / 26 x 24 x 27 in
Weight w/o accessories	50 kg	57 kg
Max. power consumption	600 W	600 W
Power supply	100 – 240 V ±10 %, 50 – 60 Hz ±5 %	100 – 240 V ±10 %, 50 – 60 Hz ±5 %
Optical confocal infrared detector	Contact-free recognition of fill level, inserted tools, labware, tip types and quantities	Contact-free recognition of fill level, inserted tools, labware, tip types and quantities
SLAS/ANSI positions	6	6
Volume range	0.2 µL – 1 mL	0.2 µL – 1 mL
Random measurement error	±0.1 mm	±0.1 mm
Systematic measurement error	±0.3 mm	±0.3 mm
Dispensing tool <sup>1)2)</sup>		
Random measurement error (1 µL)	≤3 %	≤3 %
Systematic measurement error (1 µL)	±5 %	±5 %
Random measurement error (50 µL)	≤0.4 %	≤0.4 %
Systematic measurement error (50 µL)	±1.2 %	±1.2 %
Random measurement error (1,000 µL)	≤0.15 %	≤0.15 %
Systematic measurement error (1,000 µL)	±0.7 %	±0.7 %
Pipetting type	Air-cushion	Air-cushion
Gripper option	yes	yes
Thermal module(s)	no	no
Thermal module (optional)		
Cooling rate	4 °C/min	–
Heating rate	9 °C/min	–
ThermoMixer upgrade option	no	included
ThermoMixer		
Max. load	–	1,000 g (2.2 lb)
Mixing period	–	5 s – 120 min
Speed	–	300 rpm – 2,000 rpm
Temperature range	–	15 °C below RT to 95 °C
Vacuum unit		
Vacuum max. output	–	–
Underground area	–	–
Suction time	–	–
Magnetic separation	with third party adapter and gripper	yes
Vacuum separation	no	no
Automatic tool exchange	2 tools and gripper	2 tools and gripper
UV/HEPA option	yes	yes
MagSep reagents for DNA/RNA purification	–	yes
For operation in biosafety cabinet	–	–



On page 360 you will find detailed information on services for these products!

Your local distributor: [www.eppendorf.com/contact](http://www.eppendorf.com/contact)  
Eppendorf AG · Barkhausenweg 1 · 22339 Hamburg · Germany · [eppendorf@eppendorf.com](mailto:eppendorf@eppendorf.com) · [www.eppendorf.com](http://www.eppendorf.com)



Model	epMotion® 5075i	epMotion® 5075v
Page(s)	76	78
Dimensions (W x D x H)	107 x 61 x 67 cm / 43 x 24 x 27 in	107 x 61 x 67 cm / 43 x 24 x 27 in
Weight w/o accessories	85 kg	86 kg
Max. power consumption	700 W	700 W
Power supply	100 – 240 V ±10 %, 50 – 60 Hz ±5 %	100 – 240 V ±10 %, 50 – 60 Hz ±5 %
Optical confocal infrared detector	Contact-free recognition of fill level, inserted tools, labware, tip types and quantities	Contact-free recognition of fill level, inserted tools, labware, tip types and quantities
SLAS/ANSI positions	15	12
Volume range	0.2 µL – 1 mL	0.2 µL – 1 mL
Random measurement error	±0.1 mm	±0.1 mm
Systematic measurement error	±0.3 mm	±0.3 mm
Dispensing tool <sup>1)2)</sup>		
Random measurement error (1 µL)	≤3 %	≤3 %
Systematic measurement error (1 µL)	±5 %	±5 %
Random measurement error (50 µL)	≤0.4 %	≤0.4 %
Systematic measurement error (50 µL)	±1.2 %	±1.2 %
Random measurement error (1,000 µL)	≤0.15 %	≤0.15 %
Systematic measurement error (1,000 µL)	±0.7 %	±0.7 %
Pipetting type	Air-cushion	Air-cushion
Gripper option	yes	included
Thermal module(s)	3	3
Thermal module (optional)		
Cooling rate	–	–
Heating rate	–	–
ThermoMixer upgrade option	yes	yes
ThermoMixer		
Max. load	–	–
Mixing period	–	–
Speed	–	–
Temperature range	–	–
Vacuum unit		
Vacuum max. output	–	35 NL/min
Underground area	–	–
Suction time	–	–
Magnetic separation	with third party adapter and gripper	with third party adapter and gripper
Vacuum separation	no	yes
Automatic tool exchange	4 tools and gripper	4 tools and gripper
UV/HEPA option	yes	yes
MagSep reagents for DNA/RNA purification	–	–
For operation in biosafety cabinet	–	–

<sup>1)</sup> in pipetting mode, free jet, without pre-wetting, with distilled water, at 20 °C<sup>2)</sup> See Eppendorf Application Note 168 for typical pipetting performance

Only for epMotion 5073m, 5073mc and 5075m: Limited Use Label License

Notice to purchaser; limited license for research use only

This product and its use may be covered by one or more patents owned by Gen-Probe Incorporated. The purchase price for this product includes only limited, nontransferable rights under certain claims of certain patents owned by Gen-Probe Incorporated to use this product for research purposes only. No other rights are conveyed. Purchaser is not granted any rights under patents of Gen-Probe Incorporated to use this product for any commercial use. Further information regarding purchasing a license under patents of Gen-Probe Incorporated to use this product for any other purposes, including, without limitation, for commercial use, may be obtained by contacting Gen-Probe Incorporated, Attn: Business Development Department, 10210 Genetic Center Drive, San Diego, California 92121-4362, U.S.A.

Technical specifications subject to change.



Model	epMotion® 5075t	epMotion® 5075m
Page(s)	77	77
Dimensions (W x D x H)	107 x 61 x 67 cm / 43 x 24 x 27 in	107 x 61 x 67 cm / 43 x 24 x 27 in
Weight w/o accessories	87 kg	88 kg
Max. power consumption	700 W	700 W
Power supply	100 – 240 V ±10 %, 50 – 60 Hz ±5 %	100 – 240 V ±10 %, 50 – 60 Hz ±5 %
Optical confocal infrared detector	Contact-free recognition of fill level, inserted tools, labware, tip types and quantities	Contact-free recognition of fill level, inserted tools, labware, tip types and quantities
SLAS/ANSI positions	14.5	14.5
Volume range	0.2 µL – 1 mL	0.2 µL – 1 mL
Random measurement error	±0.1 mm	±0.1 mm
Systematic measurement error	±0.3 mm	±0.3 mm
Dispensing tool <sup>1)2)</sup>		
Random measurement error (1 µL)	≤3 %	≤3 %
Systematic measurement error (1 µL)	±5 %	±5 %
Random measurement error (50 µL)	≤0.4 %	≤0.4 %
Systematic measurement error (50 µL)	±1.2 %	±1.2 %
Random measurement error (1,000 µL)	≤0.15 %	≤0.15 %
Systematic measurement error (1,000 µL)	±0.7 %	±0.7 %
Pipetting type	Air-cushion	Air-cushion
Gripper option	yes	yes
Thermal module(s)	2	2
Thermal module (optional)		
Cooling rate	–	–
Heating rate	–	–
ThermoMixer upgrade option	included	included
ThermoMixer		
Max. load	–	–
Mixing period	–	–
Speed	–	–
Temperature range	–	–
Vacuum unit		
Vacuum max. output	–	–
Underground area	–	–
Suction time	–	–
Magnetic separation	with third party adapter and gripper	yes
Vacuum separation	no	no
Automatic tool exchange	4 tools and gripper	4 tools and gripper
UV/HEPA option	yes	yes
MagSep reagents for DNA/RNA purification	–	yes
For operation in biosafety cabinet	–	–

**epServices**  
for premium performance

On page 360 you will find detailed information on services for these products!

Your local distributor: [www.eppendorf.com/contact](http://www.eppendorf.com/contact)

Eppendorf AG · Barkhausenweg 1 · 22339 Hamburg · Germany · [eppendorf@eppendorf.com](mailto:eppendorf@eppendorf.com) · [www.eppendorf.com](http://www.eppendorf.com)

# Eppendorf Research<sup>®</sup> plus

## Description

The Eppendorf Research plus is one of the most commonly used pipettes in the world. Besides safety and robustness the main focus of its design lay on ergonomics. The Research plus protects the health of our customers during their daily work. It has pioneered the renowned PhysioCare Concept<sup>®</sup> and thus reduced the strain on hand and arm during pipetting essentially. The Research plus is the pipette family with the lowest weight and lowest operation forces at Eppendorf. Lower operation forces can only be reached with our Eppendorf electronic pipettes. The spring loaded tip cone ensures low tip attachment and ejection forces. The Research plus has the ability to be autoclaved without the need to be disassembled. Fixed-volume pipettes and multichannel options are available; the Research plus pipette will become an indispensable tool in your laboratory.



## Product features

- > The ultralight Eppendorf Research plus was developed according to the strict criteria of the Eppendorf PhysioCare Concept
- > Eppendorf PerfectPiston<sup>®</sup>: Ultralight and highly resistant piston system
- > The positions and shapes of the control buttons/displays have been optimized for stress-free work procedures and intuitive operation
- > The spring-loaded tip cone provides you with an optimal pipette fit with minimal insertion force (not available for 5 mL and 10 mL pipettes)
- > The adjustment option allows you to perfectly adapt the pipette for specific liquids or other external conditions
- > With the new volume setting, you can switch from maximum to minimum volume in just a few turns
- > The 4-digit volume display with magnifying display makes quick and accurate volume settings easier than ever
- > The quick lock makes the lower part particularly easy to remove and service (not available for 5 mL and 10 mL pipettes)

## Applications

- > Forward pipetting
- > Reverse pipetting
- > Removal of supernatants
- > Sample mixing
- > Phase extraction
- > Volume determination
- > Filling of plates, gels, and reaction vessels



[www.eppendorf.com/researchplus-360](http://www.eppendorf.com/researchplus-360)



[www.eppendorf.com/researchplus-brochure](http://www.eppendorf.com/researchplus-brochure)

## Advanced ergonomics

- > Feel the difference in weight, pipetting forces and the spring loaded tip cone
- > Low tip attachment force: Achieve optimal tightness and minimal attachment forces with the Eppendorf Research plus. The spring loaded tip cone helps to reduce stress without sacrificing tightness
- > Low tip ejection force: Even small differences in the tip ejection force make a big change if you do it day by day. The tip ejection force of the Eppendorf Research plus can be as low as 3.6 N, depending on the size and the force you use to fix the tip

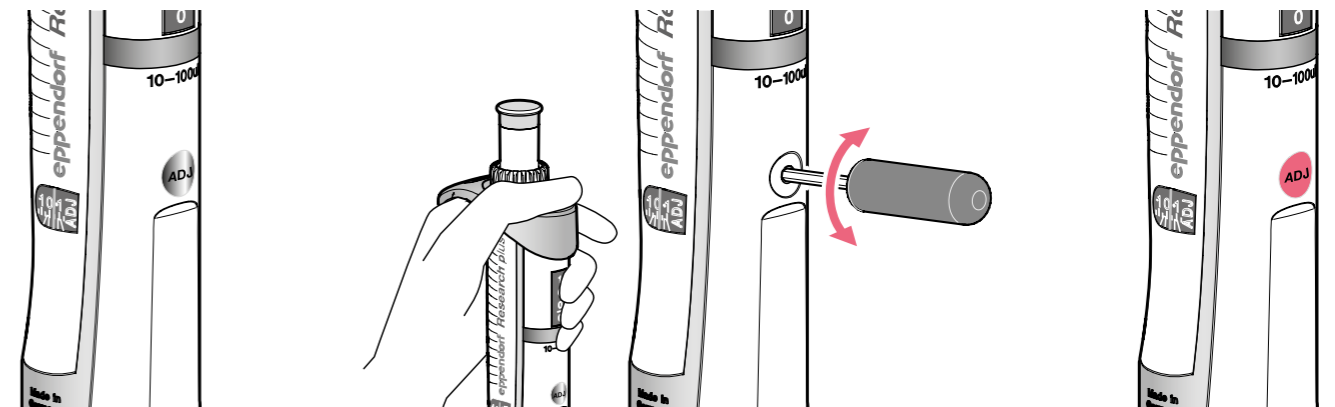

User adjustment: User-friendly option to temporarily adjust the pipetting volume by up to  $\pm 2\%$  to offset inaccuracies when working with difficult liquids (e.g., warm, cold, volatile or high density liquids) or when external conditions change (e.g., altitude or use of elongated tips). Change back to factory adjustment without calibration



The large 4 digit volume display with magnifying window is easy to read and allows for more accurate volume setting

Get ready for a threefold enjoyable pipetting experience with one of the most advanced and ergonomic pipettes in the world. The economic Research plus triple-pack is available in three different versions. In addition to three Research plus pipettes, each pack contains one set of matching Eppendorf tips and one of the popular Eppendorf ballpoint pens.



## Eppendorf Research® plus

## Ordering information

Volume range	Color code	Rel. systematic error <sup>1)</sup>	Abs. systematic error <sup>1)</sup>	Rel. random error <sup>1)</sup>	Abs. random error <sup>1)</sup>	Order no.
<b>Eppendorf Research® plus, single-channel, fixed</b>						
10 µL	medium gray	±1.2 %	±0.12 µL	±0.6 %	±0.06 µL	3124 000.016
10 µL	yellow	±1.2 %	±0.12 µL	±0.6 %	±0.06 µL	3124 000.024
20 µL	light gray	±0.8 %	±0.16 µL	±0.3 %	±0.06 µL	3124 000.032
20 µL	yellow	±1.0 %	±0.2 µL	±0.3 %	±0.06 µL	3124 000.040
25 µL	yellow	±1.0 %	±0.25 µL	±0.3 %	±0.08 µL	3124 000.059
50 µL	yellow	±0.7 %	±0.35 µL	±0.3 %	±0.15 µL	3124 000.067
100 µL	yellow	±0.6 %	±0.6 µL	±0.2 %	±0.2 µL	3124 000.075
200 µL	yellow	±0.6 %	±1.2 µL	±0.2 %	±0.4 µL	3124 000.083
200 µL	blue	±0.6 %	±1.2 µL	±0.2 %	±0.4 µL	3124 000.091
250 µL	blue	±0.6 %	±1.5 µL	±0.2 %	±0.5 µL	3124 000.105
500 µL	blue	±0.6 %	±3.0 µL	±0.2 %	±1.0 µL	3124 000.113
1,000 µL	blue	±0.6 %	±6.0 µL	±0.2 %	±2.0 µL	3124 000.121

<sup>1)</sup> The error data, according to EN ISO 8655, only apply if original Eppendorf tips are used. Technical specifications are subject to change. Errors and omissions excepted.

## Ordering information

Volume range	Color code	Volume	Rel. systematic error <sup>1)</sup>	Abs. systematic error <sup>1)</sup>	Rel. random error <sup>1)</sup>	Abs. random error <sup>1)</sup>	Order no.
<b>Eppendorf Research® plus, single-channel, variable, incl. epT.I.P.S.® Box</b>							
0.1 – 2.5 µL	dark gray	0.1 µL	±48.0 %	±0.048 µL	±12.0 %	±0.012 µL	3123 000.012
		0.25 µL	±12.0 %	±0.03 µL	±6.0 %	±0.015 µL	
		1.25 µL	±2.5 %	±0.031 µL	±1.5 %	±0.019 µL	
		2.5 µL	±1.4 %	±0.035 µL	±0.7 %	±0.018 µL	
0.5 – 10 µL	medium gray	0.5 µL	±8.0 %	±0.04 µL	±5.0 %	±0.025 µL	3123 000.020
		1 µL	±2.5 %	±0.025 µL	±1.8 %	±0.018 µL	
		5 µL	±1.5 %	±0.075 µL	±0.8 %	±0.04 µL	
		10 µL	±1.0 %	±0.1 µL	±0.4 %	±0.04 µL	
2 – 20 µL	light gray	2 µL	±5.0 %	±0.1 µL	±1.5 %	±0.03 µL	3123 000.098
		20 µL	±1.2 %	±0.12 µL	±0.6 %	±0.06 µL	
2 – 20 µL	yellow	2 µL	±5.0 %	±0.1 µL	±1.5 %	±0.03 µL	3123 000.039
		10 µL	±1.2 %	±0.12 µL	±0.6 %	±0.06 µL	
		20 µL	±1.0 %	±0.2 µL	±0.3 %	±0.06 µL	
10 – 100 µL	yellow	10 µL	±3.0 %	±0.3 µL	±1.0 %	±0.1 µL	3123 000.047
		50 µL	±1.0 %	±0.5 µL	±0.3 %	±0.15 µL	
		100 µL	±0.8 %	±0.8 µL	±0.2 %	±0.2 µL	
20 – 200 µL	yellow	20 µL	±2.5 %	±0.5 µL	±0.7 %	±0.14 µL	3123 000.055
		100 µL	±1.0 %	±1.0 µL	±0.3 %	±0.3 µL	
		200 µL	±0.6 %	±1.2 µL	±0.2 %	±0.4 µL	
30 – 300 µL	orange	30 µL	±2.5 %	±0.75 µL	±0.7 %	±0.21 µL	3123 000.101
		150 µL	±1.0 %	±1.5 µL	±0.3 %	±0.45 µL	
		300 µL	±0.6 %	±1.8 µL	±0.2 %	±0.6 µL	
100 – 1,000 µL	blue	100 µL	±3.0 %	±3.0 µL	±0.6 %	±0.6 µL	3123 000.063
		500 µL	±1.0 %	±5.0 µL	±0.2 %	±1.0 µL	
		1,000 µL	±0.6 %	±6.0 µL	±0.2 %	±2.0 µL	
<b>Eppendorf Research® plus, single-channel, variable, incl. epT.I.P.S.® sample bag</b>							
0.5 – 5 mL	violet	0.5 mL	±2.4 %	±0.012 mL	±0.6 %	±0.003 mL	3123 000.071
		2.5 mL	±1.2 %	±0.03 mL	±0.25 %	±0.006 mL	
		5 mL	±0.6 %	±0.03 mL	±0.15 %	±0.008 mL	
1 – 10 mL	turquoise	1 mL	±3.0 %	±0.03 mL	±0.6 %	±0.006 mL	3123 000.080
		5 mL	±0.8 %	±0.04 mL	±0.2 %	±0.01 mL	
		10 mL	±0.6 %	±0.06 mL	±0.15 %	±0.015 mL	

<sup>1)</sup> The error data, according to EN ISO 8655, only apply if original Eppendorf tips are used. Technical specifications are subject to change. Errors and omissions excepted.

► Pipette service and maintenance contracts can be found on page 358. Pipette tips can be found on page 38 onward.

Technical specifications subject to change.



## Ordering information

Volume range	Color code	Volume	Rel. systematic error <sup>1)</sup>	Abs. systematic error <sup>1)</sup>	Rel. random error <sup>1)</sup>	Abs. random error <sup>1)</sup>	Order no.
<b>Eppendorf Research® plus, 8-channel, variable, incl. epT.I.P.S.® Box</b>							
0.5 – 10 µL	medium gray	0.5 µL	±12.0 %	±0.06 µL	±8.0 %	±0.04 µL	3125 000.010
		1 µL	±8.0 %	±0.08 µL	±5.0 %	±0.05 µL	
		5 µL	±4.0 %	±0.2 µL	±2.0 %	±0.1 µL	
10 – 100 µL	yellow	10 µL	±2.0 %	±0.2 µL	±1.0 %	±0.1 µL	3125 000.036
		50 µL	±3.0 %	±0.3 µL	±2.0 %	±0.2 µL	
		100 µL	±1.0 %	±0.5 µL	±0.8 %	±0.4 µL	
30 – 300 µL	orange	30 µL	±3.0 %	±0.9 µL	±1.0 %	±0.3 µL	3125 000.052
		150 µL	±1.0 %	±1.5 µL	±0.5 %	±0.75 µL	
		300 µL	±0.6 %	±1.8 µL	±0.3 %	±0.9 µL	
<b>Eppendorf Research® plus, 12-channel, variable, incl. epT.I.P.S.® Box</b>							
0.5 – 10 µL	medium gray	0.5 µL	±12.0 %	±0.06 µL	±8.0 %	±0.04 µL	3125 000.028
		1 µL	±8.0 %	±0.08 µL	±5.0 %	±0.05 µL	
		5 µL	±4.0 %	±0.2 µL	±2.0 %	±0.1 µL	
		10 µL	±2.0 %	±0.2 µL	±1.0 %	±0.1 µL	
10 – 100 µL	yellow	10 µL	±3.0 %	±0.3 µL	±2.0 %	±0.2 µL	3125 000.044
		50 µL	±1.0 %	±0.5 µL	±0.8 %	±0.4 µL	
		100 µL	±0.8 %	±0.8 µL	±0.3 %	±0.3 µL	
		300 µL	±0.8 %	±0.8 µL	±0.3 %	±0.3 µL	
30 – 300 µL	orange	30 µL	±3.0 %	±0.9 µL	±1.0 %	±0.3 µL	3125 000.060
		150 µL	±1.0 %	±1.5 µL	±0.5 %	±0.75 µL	
		300 µL	±0.6 %	±1.8 µL	±0.3 %	±0.9 µL	

<sup>1)</sup> The error data, according to EN ISO 8655, only apply if original Eppendorf tips are used. Technical specifications are subject to change. Errors and omissions excepted.

## Ordering information

Description	Order no.
<b>Eppendorf Research® plus 3-pack</b> , single-channel, variable, incl. epT.I.P.S.® Box or sample bag and ballpoint pen	
<b>Option 1:</b> 0.5 – 10 µL, 10 – 100 µL, 100 – 1,000 µL	3123 000.900
<b>Option 2:</b> 2 – 20 µL yellow, 20 – 200 µL, 100 – 1,000 µL	3123 000.918
<b>Option 3:</b> 100 – 1,000 µL, 0.5 – 5 mL, 1 – 10 mL	3123 000.926

## Accessories

Description	Order no.
<b>Eppendorf Research® plus red adjustment seal ADJ</b> , 1 set = 5 pieces	3120 636.005
<b>Adjustment tool</b> , for changing factory or secondary user adjustment	3120 633.006
<b>Safety plug tools</b> , 5 pieces	3120 639.004
<b>Protection filter 5 mL</b> , 10 filters with 1 filter sleeve, for 0.5 – 5 mL variable Eppendorf Reference® 2, Eppendorf Research plus and Eppendorf Xplorer® (plus), color code: violet	4920 623.005
<b>Protection filter 10 mL</b> , 10 filters with 1 filter sleeve, for 1 – 10 mL variable Eppendorf Reference® 2, Eppendorf Research plus and Eppendorf Xplorer® (plus), color code: turquoise	4920 624.001
<b>O-ring for tip cones</b> , 24 pcs., red, for 100 and 300 µL multi-channel pipettes, with mounting aid (1 set = 24 pcs)	3122 611.000
<b>Cutting tool</b> , for O-rings of 100 and 300 µL, for Eppendorf Research® plus/Eppendorf Xplorer®	3122 610.003
<b>Key</b> , for detachment of 2 – 10 mL pipettes lower parts, for Eppendorf Research® plus, Eppendorf Reference® 2, Eppendorf Xplorer®	3120 634.002
<b>Locking ring</b> , to prevent spring action of 10 mL to 1,000 µL single channel pipettes tip cones	3120 635.009
<b>Tip-Tub reagent reservoir 70 mL</b> , autoclavable reservoir for aspirating liquids with multi-channel pipettes, 1 set = 10 reservoirs and 10 lids	0030 058.607
<b>Pipette grease with lint-free applicator</b>	0013 022.153
<b>Eppendorf TrackIT</b> , RFID Reader and Software	3903 000.014

Your local distributor: [www.eppendorf.com/contact](http://www.eppendorf.com/contact)

Eppendorf AG · Barkhausenweg 1 · 22339 Hamburg · Germany · [eppendorf@eppendorf.com](mailto:eppendorf@eppendorf.com) · [www.eppendorf.com](http://www.eppendorf.com)

# Eppendorf Reference® 2

## Description

The Eppendorf Reference 2 is our premium product. Besides improved ergonomics the focus design lay on providing the most accurate results possible, optimum user safety, reliability and robustness for a long service life. The innovative single button operation is not only fast and easy, but it also allows active aerosol<sup>1)</sup> reduction and thus protects the user, the sample and the pipette. The sturdy handle manufactured with stainless steel protects the pipette from impact and in combination with the spring loaded bumpers the Reference 2 is likely to stay within calibration even if it takes a fall. These high levels of security make the Reference 2 ideal for use with precious liquids, or in any application requiring extremely high levels of accuracy. When there can be no compromise on quality and reproducibility, Eppendorf's Reference 2 is an ideal instrument for these Liquid Handling applications.

<sup>1)</sup> An aerosol is a colloid of fine solid particles or liquid droplets, in air or another gas.



## Product features

- > The one-button operation offers a fast and ergonomic handling with reduced operating effort and active aerosol reduction. To avoid an accidental tip ejection a clear haptic feedback is provided
- > The spring loaded tip cone improves user to user reproducibility and improved ergonomics by lowering tip attachment force
- > The Reference 2 multi channel offers a high flexibility incl. a spring-loaded tip cone which can be switched on/off optionally
- > The secondary adjustment supports the easy adjustment of your Reference 2 for the most accurate pipetting of different liquids or other external conditions without the need for a full calibration
- > The quick lock enables an easy cleaning and maintenance of your pipette
- > The outstanding precision and accuracy of Reference 2 provides reliable results
- > 4 digit volume display with magnifying window to allow for easier volume identification
- > External edges made from stainless steel equip the pipette with outstanding robustness
- > An embedded RFID chip contains all relevant data regarding the pipette and offers with Eppendorf TrackIT a simple identification and documentation

## Applications

- > Forward pipetting
- > Reverse pipetting
- > Removal of supernatants
- > Sample mixing
- > Phase extraction
- > Volume determination
- > Filling of plates, gels, and reaction vessels



[www.eppendorf.com/reference2-360](http://www.eppendorf.com/reference2-360)



[www.eppendorf.com/reference2-brochure](http://www.eppendorf.com/reference2-brochure)

For more information go to [www.eppendorf.com/Reference2](http://www.eppendorf.com/Reference2)

Technical specifications subject to change.

## Ordering information

Volume range	Color code	Rel. systematic error <sup>1)</sup>	Abs. systematic error <sup>1)</sup>	Rel. random error <sup>1)</sup>	Abs. random error <sup>1)</sup>	Order no.
<b>Eppendorf Reference® 2, single-channel, fixed</b>						
1 µL	■ dark gray	±2.5 %	±0.025 µL	±1.8 %	±0.018 µL	4925 000.014
2 µL	■ dark gray	±2.0 %	±0.04 µL	±1.2 %	±0.024 µL	4925 000.022
5 µL	■ medium gray	±1.2 %	±0.06 µL	±0.6 %	±0.03 µL	4925 000.030
10 µL	■ medium gray	±1.0 %	±0.1 µL	±0.5 %	±0.05 µL	4925 000.049
10 µL	■ yellow	±1.2 %	±0.12 µL	±0.5 %	±0.05 µL	4925 000.057
20 µL	■ light gray	±0.8 %	±0.16 µL	±0.3 %	±0.06 µL	4925 000.065
20 µL	■ yellow	±1.0 %	±0.2 µL	±0.3 %	±0.06 µL	4925 000.073
25 µL	■ yellow	±1.0 %	±0.25 µL	±0.3 %	±0.075 µL	4925 000.081
50 µL	■ yellow	±0.7 %	±0.35 µL	±0.3 %	±0.15 µL	4925 000.090
100 µL	■ yellow	±0.6 %	±0.6 µL	±0.2 %	±0.2 µL	4925 000.103
200 µL	■ yellow	±0.6 %	±1.2 µL	±0.2 %	±0.4 µL	4925 000.111
200 µL	■ blue	±0.6 %	±1.2 µL	±0.2 %	±0.4 µL	4925 000.120
250 µL	■ blue	±0.6 %	±1.5 µL	±0.2 %	±0.5 µL	4925 000.138
500 µL	■ blue	±0.6 %	±3.0 µL	±0.2 %	±1.0 µL	4925 000.146
1,000 µL	■ blue	±0.6 %	±6.0 µL	±0.2 %	±2.0 µL	4925 000.154
2 mL	■ red	±0.6 %	±0.012 mL	±0.2 %	±0.004 mL	4925 000.162
2.5 mL	■ red	±0.6 %	±0.015 mL	±0.2 %	±0.005 mL	4925 000.170

<sup>1)</sup> The error data, according to EN ISO 8655, only apply if original Eppendorf tips are used. Technical specifications are subject to change. Errors and omissions excepted.

## Ordering information







Volume range	Color code	Volume	Rel. systematic error <sup>1)</sup>	Abs. systematic error <sup>1)</sup>	Rel. random error <sup>1)</sup>	Abs. random error <sup>1)</sup>	Order no.
<b>Eppendorf Reference® 2, single-channel, variable, incl. epT.I.P.S.® Box</b>							
0.1 – 2.5 µL	■ dark gray	0.1 µL	±48.0 %	±0.048 µL	±12.0 %	±0.012 µL	4924 000.010
		0.25 µL	±12.0 %	±0.03 µL	±6.0 %	±0.015 µL	
		1.25 µL	±2.5 %	±0.031 µL	±1.5 %	±0.019 µL	
		2.5 µL	±1.4 %	±0.035 µL	±0.7 %	±0.018 µL	
0.5 – 10 µL	■ medium gray	0.5 µL	±8.0 %	±0.04 µL	±5.0 %	±0.025 µL	4924 000.029
		1.0 µL	±2.5 %	±0.025 µL	±1.8 %	±0.018 µL	
		5.0 µL	±1.5 %	±0.075 µL	±0.8 %	±0.04 µL	
		10 µL	±1.0 %	±0.10 µL	±0.4 %	±0.04 µL	
2 – 20 µL	■ light gray	2.0 µL	±3.0 %	±0.06 µL	±1.5 %	±0.03 µL	4924 000.037
		10 µL	±1.0 %	±0.10 µL	±0.6 %	±0.06 µL	
		20 µL	±0.8 %	±0.16 µL	±0.3 %	±0.06 µL	
2 – 20 µL	■ yellow	2.0 µL	±5.0 %	±0.10 µL	±1.5 %	±0.03 µL	4924 000.045
		10 µL	±1.2 %	±0.12 µL	±0.6 %	±0.06 µL	
		20 µL	±1.0 %	±0.2 µL	±0.3 %	±0.06 µL	
10 – 100 µL	■ yellow	10 µL	±3.0 %	±0.3 µL	±0.7 %	±0.07 µL	4924 000.053
		50 µL	±1.0 %	±0.5 µL	±0.3 %	±0.15 µL	
		100 µL	±0.8 %	±0.8 µL	±0.2 %	±0.2 µL	
20 – 200 µL	■ yellow	20 µL	±2.5 %	±0.5 µL	±0.7 %	±0.14 µL	4924 000.061
		100 µL	±1.0 %	±1.0 µL	±0.3 %	±0.3 µL	
		200 µL	±0.6 %	±1.2 µL	±0.2 %	±0.4 µL	
30 – 300 µL	■ orange	30 µL	±2.5 %	±0.75 µL	±0.7 %	±0.21 µL	4924 000.070
		150 µL	±1.0 %	±1.5 µL	±0.3 %	±0.45 µL	
		300 µL	±0.6 %	±1.8 µL	±0.2 %	±0.6 µL	
100 – 1,000 µL	■ blue	100 µL	±3.0 %	±3.0 µL	±0.6 %	±0.6 µL	4924 000.088
		500 µL	±1.0 %	±5.0 µL	±0.2 %	±1.0 µL	
		1,000 µL	±0.6 %	±6.0 µL	±0.2 %	±2.0 µL	

<b>Eppendorf Reference® 2, single-channel, variable, incl. epT.I.P.S.® sample bag</b>							
0.25 – 2.5 mL	■ red	0.25 mL	±4.8 %	±0.012 mL	±1.2 %	±0.003 mL	4924 000.096
		1.25 mL	±0.8 %	±0.010 mL	±0.2 %	±0.0025 mL	
		2.5 mL	±0.6 %	±0.015 mL	±0.2 %	±0.005 mL	
0.5 – 5 mL	■ violet	0.5 mL	±2.4 %	±0.012 mL	±0.6 %	±0.003 mL	4924 000.100
		2.5 mL	±1.2 %	±0.030 mL	±0.25 %	±0.006 mL	
		5.0 mL	±0.6 %	±0.030 mL	±0.15 %	±0.0075 mL	
1 – 10 mL	■ turquoise	1.0 mL	±3.0 %	±0.030 mL	±0.6 %	±0.006 mL	4924 000.118
		5.0 mL	±0.8 %	±0.040 mL	±0.2 %	±0.010 mL	
		10.0 mL	±0.6 %	±0.060 mL	±0.15 %	±0.015 mL	

<sup>1)</sup> The error data, according to EN ISO 8655, only apply if original Eppendorf tips are used. Technical specifications are subject to change. Errors and omissions excepted.

## Eppendorf Reference® 2

## Ordering information

Volume range	Volume	Rel. systematic error <sup>1)</sup>	Abs. systematic error <sup>1)</sup>	Rel. random error <sup>1)</sup>	Abs. random error <sup>1)</sup>	Order no.
<b>Eppendorf Reference® 2, 8-channel, variable, incl. epT.I.P.S.® Box</b>						
0.5 – 10 µL 	0.5 µL	±12.0 %	±0.06 µL	±8.0 %	±0.04 µL	4926 000.018
	1.0 µL	±8.0 %	±0.08 µL	±5.0 %	±0.05 µL	
	5.0 µL	±4.0 %	±0.2 µL	±2.0 %	±0.1 µL	
	10 µL	±2.0 %	±0.2 µL	±1.0 %	±0.1 µL	
10 – 100 µL 	10 µL	±3.0 %	±0.3 µL	±2.0 %	±0.2 µL	4926 000.034
	50 µL	±1.0 %	±0.5 µL	±0.8 %	±0.4 µL	
	100 µL	±0.8 %	±0.8 µL	±0.3 %	±0.3 µL	
30 – 300 µL 	30 µL	±3.0 %	±0.9 µL	±1.0 %	±0.3 µL	4926 000.050
	150 µL	±1.0 %	±1.5 µL	±0.5 %	±0.75 µL	
	300 µL	±0.6 %	±1.8 µL	±0.3 %	±0.9 µL	
<b>Eppendorf Reference® 2, 12-channel, variable, incl. epT.I.P.S.® Box</b>						
0.5 – 10 µL 	0.5 µL	±12.0 %	±0.06 µL	±8.0 %	±0.04 µL	4926 000.026
	1.0 µL	±8.0 %	±0.08 µL	±5.0 %	±0.05 µL	
	5.0 µL	±4.0 %	±0.2 µL	±2.0 %	±0.1 µL	
	10 µL	±2.0 %	±0.2 µL	±1.0 %	±0.1 µL	
10 – 100 µL 	10 µL	±3.0 %	±0.3 µL	±2.0 %	±0.2 µL	4926 000.042
	50 µL	±1.0 %	±0.5 µL	±0.8 %	±0.4 µL	
	100 µL	±0.8 %	±0.8 µL	±0.3 %	±0.3 µL	
30 – 300 µL 	30 µL	±3.0 %	±0.9 µL	±1.0 %	±0.3 µL	4926 000.069
	150 µL	±1.0 %	±1.5 µL	±0.5 %	±0.75 µL	
	300 µL	±0.6 %	±1.8 µL	±0.3 %	±0.9 µL	

<sup>1)</sup> The error data, according to EN ISO 8655, only apply if original Eppendorf tips are used. Technical specifications are subject to change. Errors and omissions excepted.

## Ordering information

Description	Order no.
<b>Eppendorf Reference® 2, 3-pack</b> , single-channel, variable, incl. epT.I.P.S.® Box or sample bag and ballpoint pen	
<b>Option 1:</b> 0.5 – 10 µL, 10 – 100 µL, 100 – 1,000 µL	4924 000.908
<b>Option 2:</b> 2 – 20 µL yellow, 20 – 200 µL, 100 – 1,000 µL	4924 000.916
<b>Option 3:</b> 100 – 1,000 µL, 0.5 – 5 mL, 1 – 10 mL	4924 000.924

## Accessories

Description	Order no.
<b>Eppendorf Reference® 2 red adjustment seal ADJ</b> , incl. pin for removing the inserted seal, 1 set = 5 pieces	4920 626.004
<b>Eppendorf Reference® 2 red safety plug</b> , incl. pin for removing the inserted safety plug, 1 set = 5 pieces	4920 625.008
<b>Adjustment tool</b> , for changing factory or secondary user adjustment	3120 633.006
<b>Protection filter 2.5 mL</b> , 10 filters with 1 filter sleeve, for Eppendorf Reference® 2: 0.25 – 2.5 mL variable, 2 mL fixed volume and 2.5 mL fixed volume, color code: red	4920 622.009
<b>Protection filter 5 mL</b> , 10 filters with 1 filter sleeve, for 0.5 – 5 mL variable Eppendorf Reference® 2, Eppendorf Research plus and Eppendorf Xplorer® (plus), color code: violet	4920 623.005
<b>Protection filter 10 mL</b> , 10 filters with 1 filter sleeve, for 1 – 10 mL variable Eppendorf Reference® 2, Eppendorf Research plus and Eppendorf Xplorer® (plus), color code: turquoise	4920 624.001
<b>Cutting tool</b> , for O-rings of 100 and 300 µL, for Eppendorf Research plus/Eppendorf Xplorer®	3122 610.003
<b>Key</b> , for detachment of 2 – 10 mL pipettes lower parts, for Eppendorf Research plus, Eppendorf Reference® 2, Eppendorf Xplorer®	3120 634.002
<b>Locking ring</b> , to prevent spring action of 10 mL to 1,000 µL single channel pipettes tip cones	3120 635.009
<b>Tip-Tub reagent reservoir 70 mL</b> , autoclavable reservoir for aspirating liquids with multi-channel pipettes, 1 set = 10 reservoirs and 10 lids	0030 058.607
<b>Pipette grease with lint-free applicator</b>	0013 022.153
<b>Eppendorf TrackIT</b> , RFID Reader and Software	3903 000.014

► Pipette service and maintenance contracts can be found on page 358. Pipette tips can be found on page 38 onward.

ℹ For more information go to [www.eppendorf.com/Reference2](http://www.eppendorf.com/Reference2)

Technical specifications subject to change.

## Eppendorf Xplorer®/Xplorer plus

## Description

The Eppendorf Xplorer pipettes are electronic single, 8 and 12 channel pipettes designed to aspirate and dispense liquid volumes from 0.5 µL to 10 mL while eliminating many of potential error risks associated with manual pipetting. The intuitive operating concept and ergonomic design, supported by Eppendorf PhysioCare Concept® set new standards in simplicity, precision and reproducibility. It can be set to 9 different languages: Chinese, Dutch, English, French, German, Italian, Japanese, Portuguese and Spanish. The Xplorer pipettes are the ideal instrument if you need precisely adjustable parameters, reproducible and accurate results while experiencing fatigue-free pipetting and always maintaining full control over pipetting procedures.



## Product features

- > Intuitive operating concept for quick and easy work
- > Multifunctional rocker
- > Selection dial
- > Innovative ejector
- > Ergonomic display angle
- > Convenient handle
- > Powerful rechargeable battery
- > Flexible charging concept
- > Spring-loaded tip cone (except 5 mL and 10 mL)
- > Adjustment to external conditions (e.g. geographic height, liquids with high density)

Modes of operation	Xplorer	Xplorer plus
Pipetting (Pip): Aspiration and Dispensing of liquids.	■	■
Manual Pipetting (Man): Aspiration of liquid can be manually stopped prior to reaching the max set volume; used for volume determination.	■	■
Pipetting and Mixing (P/M): Samples are aspirated and dispensed automatically followed by an adjustable number of mixing cycles.	■	■
Dispensing (Dis): Dispensing of liquid in equal partial volumes.	■	■
Automatic Dispensing (Ads): Automatic dispensing of liquid in equal partial volumes at user defined time intervals.	■	■
Special mode (Spc) – Multi Aspiration: Consecutive aspiration for pooling into one pipette tip.		■
Special mode (Spc) – Sequential Dispensing: Aspiration of liquid followed by dispensing it in up to 10 user-defined volume steps.		■
Special mode (Spc) – Reverse Pipetting: Over-aspiration of liquid followed by a regular dispensing step. Ideal for non-aqueous solutions.		■
Special mode (Spc) – Diluting: Aspiration of a diluent and a sample separated by an air bubble.		■
Special mode (Spc) – Sequential pipetting: Pipetting of up to 10 user-defined volumes in sequential order.		■
Fix Volume (Fix): Save up to 10 of your most frequently used volumes including aspiration and dispense speed for ease of operation.		■
Programming (Prg): Save up to 10 of your most common methods with up to 4 different pipetting steps each.		■
Options (Opt): Save favorite settings, set service intervals, activate key lock and more.	■	■



[www.eppendorf.com/xplorer-360](http://www.eppendorf.com/xplorer-360)

[www.eppendorf.com/xplorer-brochure](http://www.eppendorf.com/xplorer-brochure)

ℹ For more information go to [www.eppendorf.com/Xplorer](http://www.eppendorf.com/Xplorer)

Your local distributor: [www.eppendorf.com/contact](http://www.eppendorf.com/contact)  
Eppendorf AG · Barkhausenweg 1 · 22339 Hamburg · Germany · [eppendorf@eppendorf.com](mailto:eppendorf@eppendorf.com) · [www.eppendorf.com](http://www.eppendorf.com)





# Eppendorf Xplorer®/Xplorer plus

Accessories	Order no.
<b>Description</b>	
<b>Spare charging cable</b> , for Eppendorf Xplorer®, electronic Eppendorf Multipipette®, and charger stand	4986 603.005
<b>Spare charging cable</b> , for charger carousel for Eppendorf Xplorer® and electronic Eppendorf Multipipette®	4880 603.006
<b>Protection filter 5 mL</b> , 10 filters with 1 filter sleeve, for 0.5 – 5 mL variable Eppendorf Reference® 2, Eppendorf Research plus and Eppendorf Xplorer® (plus), color code: violet	4920 623.005
<b>Protection filter 10 mL</b> , 10 filters with 1 filter sleeve, for 1 – 10 mL variable Eppendorf Reference® 2, Eppendorf Research® plus and Eppendorf Xplorer® (plus), color code: turquoise	4920 624.001
<b>O-ring for tip cones, 24 pcs.</b> , red, for 100 and 300 µL multi-channel pipettes, with mounting aid (1 set = 24 pcs)	3122 611.000
<b>Cutting tool</b> , for O-rings of 100 and 300 µL, for Eppendorf Research® plus/Eppendorf Xplorer®	3122 610.003
<b>O-ring for tip cones, 24 pcs.</b> , red, for 1,200 µL multi-channel pipettes, (1 set = 24 pcs)	4860 716.009
<b>Key</b> , for detachment of 2 – 10 mL pipettes lower parts, for Eppendorf Research® plus, Eppendorf Reference® 2, Eppendorf Xplorer®	3120 634.002
<b>Key</b> , for detachment of 1,200 µL pipettes lower parts, for Eppendorf Xplorer®	4861 605.006
<b>Locking ring</b> , to prevent spring action of 10 mL to 1,000 µL single channel pipettes tip cones	3120 635.009
<b>Locking clip for 8-channel pipette</b> , to prevent spring action of tip cones	3122 612.006
<b>Locking clip for 12-channel pipette</b> , to prevent spring action of tip cones	3122 613.002
<b>Tip-Tub reagent reservoir 70 mL</b> , autoclavable reservoir for aspirating liquids with multi-channel pipettes, 1 set = 10 reservoirs and 10 lids	0030 058.607
<b>Eppendorf TrackIT</b> , RFID Reader and Software	3903 000.014



2. With Charger Stand 2, the Xplorer/ Xplorer plus or Multipipette E3/E3x is always fully charged and ready for use. Pipette Stand 2 carries one Multipipette M4.
  - > Large rubber feet protect stands and carousels from liquids spilled on lab bench
  - > Charger Stand 2 with cord wrap functionality for more convenience

3. Place your pipette and Multipipette where you need them: Mounted to a wall, on the shelf above your bench or inside a biological safety cabinet.
  - > Pictograms on all holders for clear assignment in the lab
  - > Pipette holders are downwards compatible for Eppendorf Research and Reference pipettes

## NEW - Eppendorf Pipette Holder System

### Description

Carousels, stands and wall mount devices: The new Pipette Holder System is perfect for all users of handheld liquid handling instruments, who need a highly flexible system for their Eppendorf pipettes and Multipipettes. Carousels and stands provide a robust design with a small footprint. To save precious bench-top space carousels carry both manual and electronic instruments. And only Eppendorf offers a charger carousel with intelligent charging electronics that carries up to 6 instruments.



1. The Pipette Carousel 2 for manual pipettes and the Charger Carousel 2 for electronic devices offer more flexibility and more capacity than ever before.
  - > Rotatable pipette holders carry all current manual Eppendorf pipettes and most predecessors
  - > Charger Carousel 2 for up to six electronic devices with magnetic power connector for fast and easy connection

### Ordering information

Description	Order no.
<b>Pipette Carousel 2</b> , for 6 Eppendorf Research®, Research® plus, Reference®, Reference® 2 or Biomaster®, additional pipette holders are optionally available	3116 000.015
<b>Charger Carousel 2</b> , for 6 Eppendorf Xplorer® or Xplorer® plus, mains/power adapter included, additional charger shells and pipette holders are optionally available	3116 000.023
<b>Charger Stand 2</b> , for one Eppendorf Xplorer® or Xplorer® plus, operated with mains/power adapter supplied with Eppendorf Xplorer® or Xplorer® plus	3116 000.031
<b>Charger Stand 2</b> , for one Eppendorf Multipipette® E3/E3x or Multipipette® stream/Xstream, operated with mains/power adapter supplied with Eppendorf Multipipette® E3/E3x or Multipipette® stream/Xstream	3116 000.040
<b>Pipette Stand 2</b> , for one Eppendorf Multipipette® M4, without charging functionality, additional pipette holders are optionally available	3116 000.058
<b>Pipette Holder 2</b> , for one Eppendorf Research®, Research® plus, Reference® 2 or Biomaster®, for Pipette Carousel 2 and Charger Carousel 2 or wall mounting, sticky tape included	3116 000.112
<b>Pipette Holder 2</b> , for one Eppendorf Xplorer® or Xplorer® plus, for Pipette Carousel 2 or wall mounting, sticky tape included, without charging functionality	3116 000.120
<b>Pipette Holder 2</b> , for one Eppendorf Multipipette® E3/E3x or Eppendorf Multipipette® stream/Xstream, for Pipette Carousel 2 or wall mounting, sticky tape included, without charging functionality	3116 000.139
<b>Pipette Holder 2</b> , for one Eppendorf Multipipette® M4, for Pipette Carousel 2 and Charger Carousel 2 or wall mounting, sticky tape included	3116 000.147
<b>Charger Shell 2</b> , for one Eppendorf Xplorer® or Xplorer® plus, for Charger Carousel 2 (with charging functionality)	3116 602.007
<b>Charger Shell 2</b> , for one Eppendorf Multipipette® E3/E3x or Eppendorf Multipipette® stream/Xstream, for Charger Carousel 2, with charging functionality	3116 603.003



[www.eppendorf.com/pipetteholder-brochure](http://www.eppendorf.com/pipetteholder-brochure)



[www.eppendorf.com/pipetteholder-360](http://www.eppendorf.com/pipetteholder-360)

# Eppendorf Purity Grades for Tips



**Eppendorf epT.I.P.S.<sup>®</sup>, ep Dualfilter T.I.P.S.<sup>®</sup> and Combitips advanced<sup>®</sup> stand for highest quality and purity**  
 The high precision and accuracy of pipette tips and Combitips<sup>®</sup> is guaranteed by precise molding. Each lot of pipette tips and Combitips is subject to gravimetric measurement during final testing. Low wetting ensures reliable volume readings and minimal adhesion. Pipette tips and Combitip cylinders are made of PP (polypropylene). A relatively inert plastic characterized by low wettability as well as high dimensional and mechanical stability across a wide temperature range. For the Combitips advanced pistons PE (polyethylene) is used. This is due to the fact that ideal running properties between two parts can only be achieved by using two different types of plastic. Our tips are available in a variety of purity grades (see table beside). For further details please read page 14 - 15.



**Pure Quality**  
 With the strictest control criteria, internally and externally monitored, we guarantee the consistently high quality of our products – from lot to lot. Our consumables are available in a variety of purity qualities. Eppendorf Quality™ as well as more advanced purity grades: “Sterile, Protein-free, PCR clean, Eppendorf Forensic DNA Grade, and Eppendorf Biopur<sup>®</sup>”. In addition to our internal process controls and general quality certificates, lot-specific certificates are provided by an external accredited laboratory for the Sterile, Protein-free, PCR clean, Eppendorf Forensic DNA Grade, and Eppendorf Biopur purity grades. This allows us to consistently meet our customer’s high demands when it comes to purity ([www.eppendorf.com/purity](http://www.eppendorf.com/purity)). As a special service, we make the inspection certificate for each delivered lot available online ([www.eppendorf.com/certificates](http://www.eppendorf.com/certificates)).

Purity grades	Eppendorf Quality™	Eppendorf sterile	Eppendorf PCR clean	Eppendorf sterile and PCR clean	Eppendorf Forensic DNA Grade <sup>4)</sup>	Eppendorf Biopur <sup>®</sup>
<b>Continuous quality control for the following relevant criteria:</b>						
Function, tightness, precision	■	■	■	■	■	■
Low wetting	■	■	■	■	■	■
High chemical resistance	■	■	■	■	■	■
High thermal resistance	■	■	■	■	■	■
High resistance to centrifugation forces <sup>1)</sup>	■	■	■	■	■	■
High transparency	■	■	■	■	■	■
Precisely shaped	■	■	■	■	■	■
<b>Lot-specific certified<sup>2)</sup> for the following purity criteria:</b>						
Pyrogen-free (endotoxin-free)		■		■		■
Sterile (Ph.Eur./USP)		■		■		■
Human DNA-free			■	■	■	■
DNA-free (Human- and bacteria DNA)			■	■	■	■
DNase-free			■	■	■	■
RNase-free			■	■	■	■
PCR-inhibitor-free			■	■	■	■
ATP-free			■	■	■	■
<b>Eppendorf tips</b>						
epT.I.P.S. <sup>®</sup> Standard, Box and Set	■					
epT.I.P.S. <sup>®</sup> Reloads	■					
epT.I.P.S. <sup>®</sup> Racks			■ <sup>3)</sup>			
epT.I.P.S. <sup>®</sup> Singles						■
ep Dualfilter T.I.P.S. <sup>®</sup>				■	■	
ep Dualfilter T.I.P.S. <sup>®</sup> SealMax				■	■	
ep Dualfilter T.I.P.S. <sup>®</sup> LoRetention				■	■	
Combitips advanced <sup>®</sup>	■		■ <sup>3)</sup>		■	■
epT.I.P.S. <sup>®</sup> LoRetention	■		■			
epT.I.P.S. <sup>®</sup> Motion	■		■			
epT.I.P.S. <sup>®</sup> Motion filtertips	■		■			

<sup>1)</sup> For accurate details regarding resistance to centrifugation, please refer to the respective product pages. <sup>2)</sup> Lot-specific certificate can be downloaded from [www.eppendorf.com/certificates](http://www.eppendorf.com/certificates). <sup>3)</sup> Only available in North America. <sup>4)</sup> According to ISO 18385.



[www.eppendorf.com/puritygrades-brochure](http://www.eppendorf.com/puritygrades-brochure)

# epT.I.P.S.<sup>®</sup>

## Description

For epT.I.P.S. – the original Eppendorf “Totally Integrated Pipetting System” – the tips are optimally coordinated to Eppendorf pipettes and, of course, meet EN ISO 8655 requirements. This has resulted in minimal attachment and ejection forces with the highest level of tightness. epT.I.P.S. pipette tips can be used with pipettes from other manufacturers. Optimal wetting properties, high transparency and special, certified purity grades are the visible expression of our product and production philosophy.



## Product features

- > The ergonomically optimized cone geometry provides the optimal pipette fit on the Eppendorf pipette
- > epT.I.P.S. pipette tips can be used universally, including pipette models from other manufacturers
- > Fine graduations make visual checks of the pipetting volume even easier
- > Long, narrow tips reach the base of narrow and high vessels without touching the top of the vessel edge
- > Fine retracted or extended tips simplify work with small volumes
- > Available in purity grades of: Eppendorf Quality, PCR clean, Eppendorf Biopur<sup>®</sup>
- > Color-coded trays make volume identification and allocation of Eppendorf pipettes easier than ever

## Applications

- > Pipetting liquids
- > Dispensing liquids
- > Mixing liquids
- > Filling plates and reaction vessels
- > Filling gels for electrophoresis
- > Phase extraction and removal of supernatants

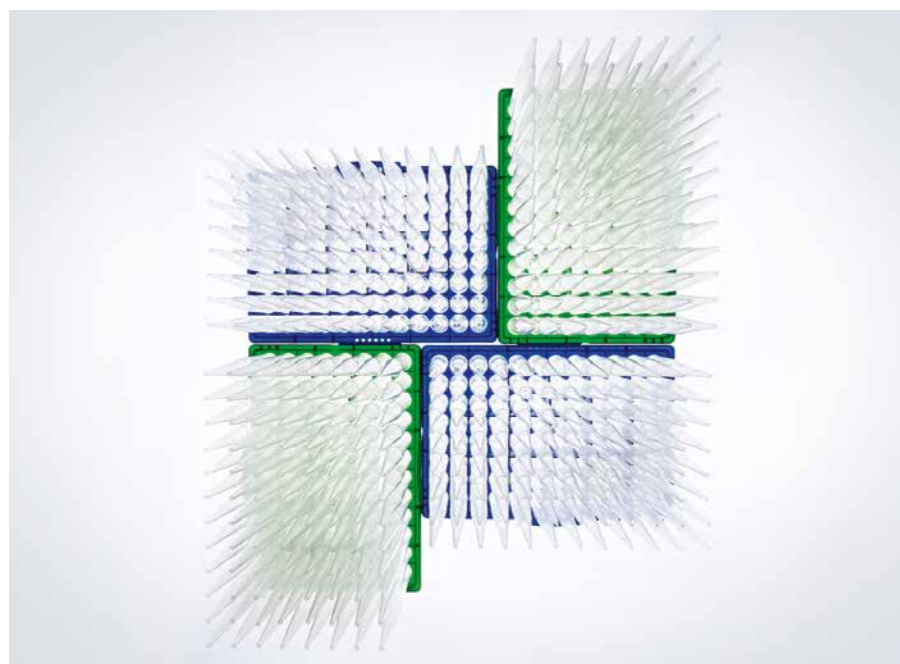

[www.eppendorf.com/appnote354](http://www.eppendorf.com/appnote354)

For more information go to [www.eppendorf.com/epTips](http://www.eppendorf.com/epTips)



## epT.I.P.S.<sup>®</sup> Standard

- > Original, high-quality Eppendorf pipette tips packaged in resealable bags
- > Available in sizes from 10 µL to 10 mL in Eppendorf Quality purity grade
- > epT.I.P.S. Standard 200 µL, 300 µL and 1,000 µL tips are also available color-coded yellow and blue
- > epT.I.P.S. Standard pipette tips can be autoclaved at 121 °C in 20 min.



## epT.I.P.S.<sup>®</sup> Box/epT.I.P.S.<sup>®</sup> Set

- > Contamination-free transfer of trays to stable working box
- > System optimized for use with multichannel pipettes
- > Color-coded trays for simple identification of tips and pipette
- > Tips can be attached to pipette from refill trays
- > Boxes and trays are autoclavable
- > epT.I.P.S. Box and epT.I.P.S. Set available in Eppendorf Quality



## epT.I.P.S.<sup>®</sup> Racks

- > Eppendorf Biopur pipette tips offer the highest biological purity grade
- > Guaranteed PCR clean, sterile, pyrogen-, ATP- and DNA-free
- > Each production lot inspected continuously by independent laboratory
- > Lot-specific certificates available at [www.eppendorf.com/certificates](http://www.eppendorf.com/certificates)
- > Packed in racks with 96, 48 or 24 tips



## epT.I.P.S.<sup>®</sup> Singles

- > Eppendorf Biopur pipette tip, individually wrapped
- > Guaranteed PCR clean, sterile, pyrogen-, ATP- and DNA-free
- > Batch number and expiration date on each blister package
- > Each production lot inspected continuously by independent laboratory
- > Lot-specific certificates available at [www.eppendorf.com/certificates](http://www.eppendorf.com/certificates)

epT.I.P.S.<sup>®</sup>**epT.I.P.S.<sup>®</sup> Reloads**

- > Reduced waste as compared with disposable racks
- > The refill trays can be autoclaved up to 121 °C 20 min., in packaging and without foil, for subsequent use
- > The refill system, depending on tips size, is packaged as either dual-sided or in stack form
- > Available in purity grades of Eppendorf Quality and PCR clean
- > Color-coded trays for simple volume and pipette identification

## Special Tips

**Eppendorf GELoader<sup>®</sup>**

- > Special tip for gel electrophoresis, loading of polyacrylamide gels
- > Flexible long and narrow tips for handling of smallest volumes
- > GELoader tips and rack autoclavable
- > Highest precision and accuracy when used with Eppendorf pipettes for 0.5 to 10 µL (gray control button)

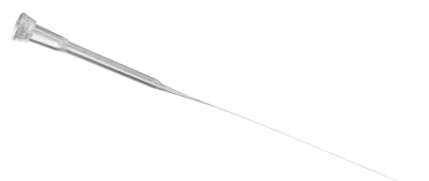
**Eppendorf Microloader<sup>™</sup>**

- > Extremely long, fine and flexible tip for filling of microcapillaries for microinjection and where additional reach is needed
- > Microloader tips and rack autoclavable
- > Highest precision and accuracy when used with Eppendorf pipettes for 0.5 to 10 µL (gray control button)

> Ordering information see page 51

Technical specifications subject to change.

epT.I.P.S.<sup>®</sup> Long**Description**

With the slim design of the extra long epT.I.P.S. and ep Dualfilter T.I.P.S. pipette tips, you always achieve best results when pipetting into Eppendorf Tubes<sup>®</sup> 5.0 mL, conical tubes, cell culture flasks, deep wells and other deep vessels. Furthermore, the risk of touching the walls of these deep vessels is minimized and cross-contamination is virtually eliminated. Extra long epT.I.P.S. are available in the following volumes:

- > 0.5 – 20 µL L (46 mm)
- > 50 – 1,250 µL L (103 mm)
- > 0.2 – 5 mL L (175 mm)
- > 0.5 – 10 mL L (243 mm)

**Product features**

- > Slim design of the extra long epT.I.P.S. and ep Dualfilter T.I.P.S. pipette tips
- > Always obtain best results when pipetting from and into Eppendorf Tubes<sup>®</sup> 5.0 mL, conical tubes, cell culture flasks, deep wells and other deep vessels
- > The risk of touching the walls of deep vessels is minimized and cross-contamination is virtually eliminated
- > Available in Eppendorf Quality, PCR clean, PCR clean/Sterile (sterile and pyrogen-free), and Eppendorf Biopur<sup>®</sup> purity grades
- > Also available as ep Dualfilter T.I.P.S. filter tips

**Applications**

- > Pipetting liquids
- > Dispensing liquids
- > Mixing liquids
- > Filling plates and reaction vessels
- > Filling gels for electrophoresis
- > Phase extraction and removal of supernatants



[www.eppendorf.com/eptips-video](http://www.eppendorf.com/eptips-video)

For more information go to [www.eppendorf.com/epTips](http://www.eppendorf.com/epTips)

Your local distributor: [www.eppendorf.com/contact](http://www.eppendorf.com/contact)  
Eppendorf AG · Barkhausenweg 1 · 22339 Hamburg · Germany · [eppendorf@eppendorf.com](mailto:eppendorf@eppendorf.com) · [www.eppendorf.com](http://www.eppendorf.com)

## ep Dualfilter T.I.P.S.<sup>®</sup>

### Description

ep Dualfilter T.I.P.S. filter tips are filter tips with a two-phase filter for contamination protection. The two filter layers made of flexible, hydrophobic material, fit perfectly in the tip cone and retain practically 100 % of all aerosols<sup>1)</sup> and biomolecules. This filtering effect is achieved using various, well-defined pore sizes. The layer facing the sample provides protection from drops, splashes and aerosols. The layer facing the pipette cone functions as a second barrier from contamination, and dependably binds biomolecules. A defined air passage rate guarantees full sample recovery and the customary quick pipetting.

### Product features

- > Dual protection against aerosols<sup>1)</sup> and biomolecules
- > Dual protection for pipette and sample
- > Free of PCR inhibitor additives
- > Available in Eppendorf PCR clean/Sterile (sterile and pyrogen-free) and Eppendorf Forensic DNA Grade
- > Tested at the Fraunhofer Institute for Toxicology and Experimental Medicine (ITEM) in Hannover, Germany
- > Continuous inspection of each production lot by an independent laboratory
- > Lot-specific certificates are available at: [www.eppendorf.com/certificates](http://www.eppendorf.com/certificates).
- > Certificate of filter efficiency acc. to EN 1822 available at: [www.eppendorf.com/certificates](http://www.eppendorf.com/certificates)

### Applications

- > DNA applications (e.g. PCR)
- > RNA applications (e.g. Gene expression analysis)
- > Protein applications (e.g. Antibody Research)
- > Cell Culture applications (e.g. Media)
- > Applications with radio actives
- > All applications which use aerosol<sup>1)</sup> binding liquids

<sup>1)</sup> An aerosol is a colloid of fine solid particles or liquid droplets, in air or another gas.

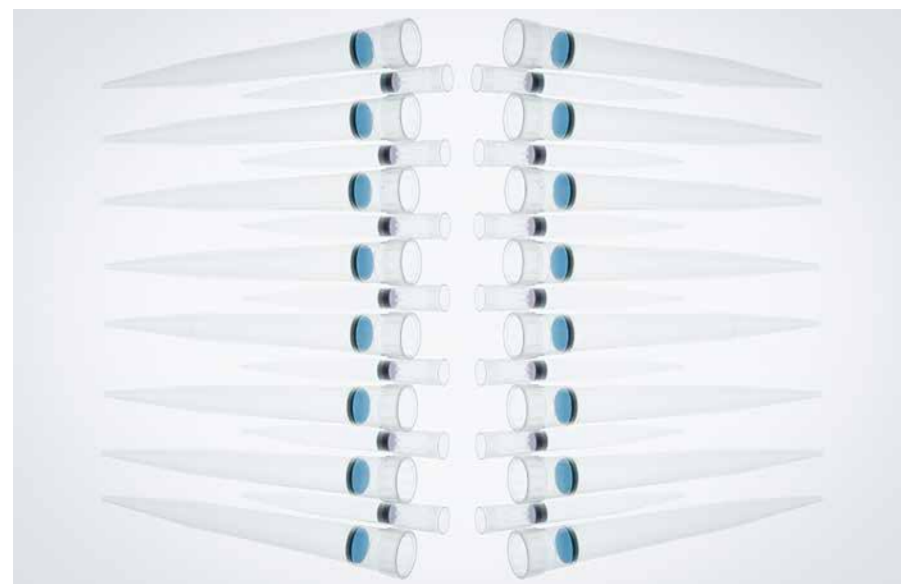

► Ordering information see page 50

Technical specifications subject to change.

## ep Dualfilter T.I.P.S.<sup>®</sup> SealMax

### Description

The violet and white filter for the ep Dualfilter T.I.P.S.<sup>®</sup> SealMax filter tips combine a reliable contamination protection for your pipette from your sample liquid with virtually 100 % protection from aerosols<sup>1)</sup> and biomolecules. This Dualfilter closes immediately when it comes into contact with the overpipetted sample without inhibiting valuable material. Additionally drops and splashes are retained by the white layer, the violet layer forms the highly-effective barrier against sample liquid. Further information and certification on specific sample recovery features, PCR inhibition and aerosol protection are available on your local Eppendorf website.

### Product features

- > Reliable protection from liquids
- > Reliable protection from aerosols<sup>1)</sup> and biomolecules
- > No PCR inhibiting additives
- > Protection of your pipette from aggressive liquids when over-aspiration occurs
- > Available in PCR clean/Sterile (sterile and pyrogen-free)
- > Continuous inspection of each production lot by an independent laboratory guarantees high purity and quality
- > Lot specific purity certificates available at: [www.eppendorf.com/certificates](http://www.eppendorf.com/certificates)
- > Certificate of filter efficiency acc. to EN 1822 available at: [www.eppendorf.com/certificates](http://www.eppendorf.com/certificates)



### Applications

- > DNA applications (e.g. PCR)
- > RNA applications (e.g. Gene expression analysis)
- > Protein applications (e.g. Antibody Research)
- > Cell Culture applications (e.g. Media)
- > Applications with radio actives
- > All applications which use aerosol<sup>1)</sup> binding liquids

<sup>1)</sup> An aerosol is a colloid of fine solid particles or liquid droplets in air or another gas.

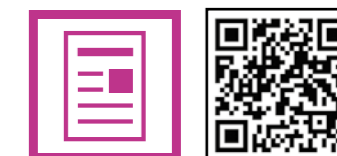

[www.eppendorf.com/appnote327](http://www.eppendorf.com/appnote327)

► For more information go to [www.eppendorf.com/epTips](http://www.eppendorf.com/epTips)

Your local distributor: [www.eppendorf.com/contact](http://www.eppendorf.com/contact)  
Eppendorf AG · Barkhausenweg 1 · 22339 Hamburg · Germany · [eppendorf@eppendorf.com](mailto:eppendorf@eppendorf.com) · [www.eppendorf.com](http://www.eppendorf.com)

# epT.I.P.S.<sup>®</sup> LoRetention

## Description

epT.I.P.S. LoRetention pipette tips and ep Dualfilter T.I.P.S. LoRetention filter tips are particularly well-suited for applications with samples that contain detergents. Detergents or detergent containing liquids lower the liquid's surface tension. This leads to a phenomenon called "wetting": Residual liquid sticks to the tip wall and cannot be recovered. The invisible film left behind in standard tips shows a significantly high amount of valuable sample material, which becomes discarded together with the tip.

Particularly when it comes to sensitive PCR and *real-time* PCR applications, low retention surfaces can increase the reproducibility and significantly reduce the loss of expensive reagents.

The low retention property of epT.I.P.S. LoRetention pipette tips and ep Dualfilter T.I.P.S. LoRetention filter tips is generated by an ultrahydrophobic, extremely homogeneous surface. It is achieved through an innovative treatment at the molecular level – the "Pearl Effect" Technology. All pipette tips are uncoated, free of additives and do not leach into the sample. Liquids containing detergents simply roll off, so that practically no liquid remains in the tip. These outstanding material properties guarantee maximum sample recovery for cost saving and improved reproducibility.



The "Pearl Effect" – a comparison of the amount of residual liquid when pipetting solutions that contain detergents:

1. Significant loss of sample using standard tips
2. Maximum recovery with epT.I.P.S. LoRetention

## Applications

- > Cell culture (media)
- > Genomics: PCR, RT-PCR, qPCR and all other types of PCR
- > Enzymatic reactions (restriction decomposition, ligation)
- > Isolation and purification of nucleic acid
- > Gel electrophoresis (e.g., prefabricated DNA ladders) typical detergents: SDS, Triton<sup>®</sup>, X-100, Brij<sup>®</sup> 35, Tween<sup>®</sup> 20, CHAPS
- > Proteomics (all types of protein examinations)
- > Protein isolation and purification

## Product features

- > Ultrahomogenous surface for maximum reproducibility
- > Ultrahydrophobic surface for minimal sample loss
- > Significantly reduced foam formation during pipetting
- > Extreme resistance to chemicals
- > Available in PCR clean and Eppendorf Quality
- > Also available as ep Dualfilter T.I.P.S. in PCR clean/Sterile (sterile and pyrogen-free)
- > No coating
- > Lot-specific certificates are available at: [www.eppendorf.com/certificates](http://www.eppendorf.com/certificates).

## Maximum reproducibility in Genomics

epT.I.P.S. LoRetention are especially recommended for applications where highest precision of DNA/RNA analysis results are needed, such as for PCR and *real-time* PCR. For example expensive master mixes and enzyme solutions tend to adhere to the tips inner surface. Specially treated low retention surfaces are created to repel detergent solutions to a maximum – for minimum loss of your valuable sample.

## Examples for liquids with wetting effect:

- > Master mixes
- > Enzyme solutions: enzyme restrictions, ligation, DNase
- > DNA ladders for gel electrophoresis

epT.I.P.S. LoRetention perform considerably better in terms of precision and sample recovery than standard pipette tips as shown in **Fig. 1**.

## Maximum reproducibility in Proteomics

Not only in molecular biology high sensitivity detection methods require extreme reliability and reproducibility in pipetting. Also in protein analysis and purification the reagents and samples often contain detergents, like e.g. SDS-Page. By minimizing sample retention and improving reproducibility of pipetting, epT.I.P.S. LoRetention pipette tips and ep Dualfilter T.I.P.S. LoRetention filter tips are especially advantageous in proteomic applications.

## Routine protein applications:

- > Isolation
- > Purification
- > Denaturation

The facts are self explanatory – when compared to standard pipette tips, epT.I.P.S. LoRetention showed markedly better results in terms of precision and sample recovery, as displayed in **Fig. 1 and 2**.

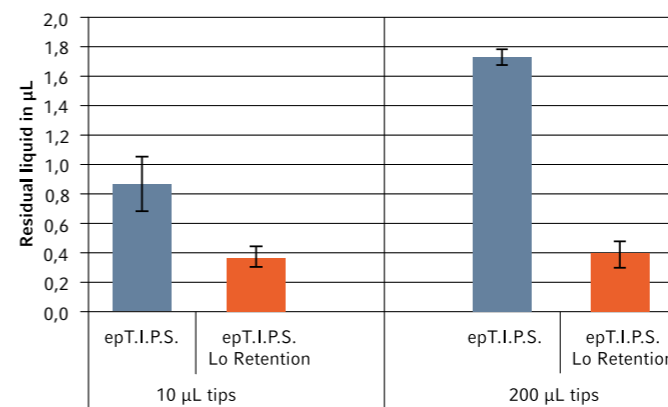

**Fig. 1:**

Comparison of residual liquid of epT.I.P.S. and epT.I.P.S. LoRetention with master mix for *real-time* PCR. Once the liquid had been dispensed, the residual liquid in the tips was determined. The measurements were repeated several times and the standard deviation was determined. epT.I.P.S. LoRetention resulted in the lowest residual liquid.

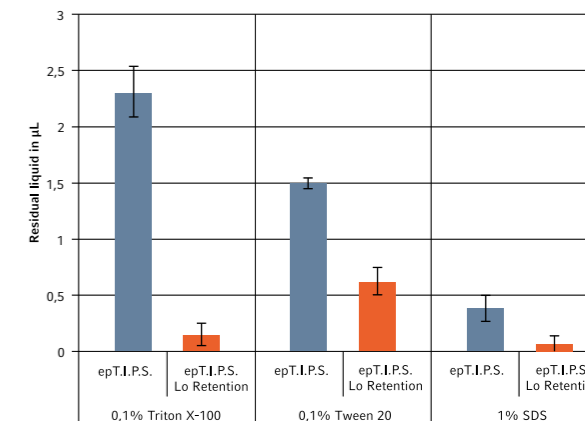







**Fig. 2:**

Comparison of resistance of the low retention property when subjected to solvents typically used in proteomics. 200 µL epT.I.P.S. and epT.I.P.S. LoRetention were treated with the solvents specified. An enzymatic buffer containing detergents was then pipetted and the residual moisture was determined. epT.I.P.S. LoRetention resulted in reproducible low levels of residual liquids.



## Liquid Handling

Volume range/epT.I.P.S.®  
epT.I.P.S.® LoRetention  
(all tips shown are actual size)

	Standard/Bulk	Reloads	Reloads
	1,000 tips (2 bags × 500 tips) 0030 000.811	960 tips (10 trays × 96 tips) 0030 073.371* 0030 072.049 LoRetention	960 tips (10 trays × 96 tips) 0030 073.754* 0030 072.006 LoRetention
0.1 – 10 µL, 34 mm			
	1,000 tips (2 bags × 500 tips) 0030 000.838	960 tips (10 trays × 96 tips) 0030 073.398*	960 tips (10 trays × 96 tips) 0030 073.770*
0.1 – 20 µL, 40 mm			
	1,000 tips (2 bags × 500 tips) 0030 000.854	960 tips (10 trays × 96 tips) 0030 073.410* 0030 072.057 LoRetention	960 tips (10 trays × 96 tips) 0030 073.797* 0030 072.014 LoRetention
0.5 – 20 µL, 46 mm			
	1,000 tips (2 bags × 500 tips) 0030 000.889 0030 000.870 yellow tips	960 tips (10 trays × 96 tips) 0030 073.436* 0030 072.065 LoRetention	960 tips (10 trays × 96 tips) 0030 073.819* 0030 072.022 LoRetention
2 – 200 µL, 53 mm			
	1,000 tips (2 bags × 500 tips) 0030 000.900 0030 000.897 yellow tips	960 tips (10 trays × 96 tips) 0030 073.452*	960 tips (10 trays × 96 tips) 0030 073.835*
20 – 300 µL, 55 mm			
	1,000 tips (2 bags × 500 tips) 0030 000.927 0030 000.919 blue tips	960 tips (10 trays × 96 tips) 0030 073.479* 0030 072.073 LoRetention	960 tips (10 trays × 96 tips) 0030 073.851* 0030 072.030 LoRetention
50 – 1,000 µL, 71 mm			
	1,000 tips (2 bags × 500 tips) 0030 000.935	960 tips (10 trays × 96 tips) 0030 073.495*	960 tips (10 trays × 96 tips) 0030 073.878*
50 – 1,250 µL, 76 mm			

\* not available before May 2018









## Liquid Handling

Box	Set	Singles	Racks
1 reusable box × 96 tips 0030 073.010*	480 tips (5 trays × 96 tips), 1 reusable box 0030 073.215* 0030 072.251 LoRetention		
1 reusable box × 96 tips 0030 073.037*	480 tips (5 trays × 96 tips), 1 reusable box 0030 073.231*	100 tips, individually packed 0030 010.027*	480 tips (5 racks × 96 tips) 0030 075.013*
1 reusable box × 96 tips 0030 073.053*	480 tips (5 trays × 96 tips), 1 reusable box 0030 073.258* 0030 072.260 LoRetention		
1 reusable box × 96 tips 0030 073.070*	480 tips (5 trays × 96 tips), 1 reusable box 0030 073.274* 0030 072.278 LoRetention	100 tips, individually packed 0030 010.043*	480 tips (5 racks × 96 tips) 0030 075.030*
1 reusable box × 96 tips 0030 073.096*	480 tips (5 trays × 96 tips), 1 reusable box 0030 073.290*		480 tips (5 racks × 96 tips) 0030 075.056*
1 reusable box × 96 tips 0030 073.118*	480 tips (5 trays × 96 tips), 1 reusable box 0030 073.312* 0030 072.286 LoRetention	100 tips, individually packed 0030 010.060*	480 tips (5 racks × 96 tips) 0030 075.072*
1 reusable box × 96 tips 0030 073.134*	480 tips (5 trays × 96 tips), 1 reusable box 0030 073.339*		480 tips (5 racks × 96 tips) 0030 075.099*









## Liquid Handling

Volume range/epT.I.P.S. <sup>®</sup> epT.I.P.S. <sup>®</sup> LoRetention (all tips shown are actual size)	Standard/Bulk	Reloads	Reloads
<b>dark green</b>	1,000 tips (2 bags × 500 tips)	960 tips (10 trays × 96 tips)	960 tips (10 trays × 96 tips)
50 – 1,250 µL L, 103 mm	0030 000.730	0030 073.630*	0030 073.649*
			
<b>red</b>	500 tips (5 bags × 100 tips)	480 tips (10 trays × 48 tips)	480 tips (10 trays × 48 tips)
0.25 – 2.5 mL, 115 mm	0030 000.951	0030 073.517*	0030 073.894*
			
<b>violet</b>	500 tips (5 bags × 100 tips)		
0.1 – 5 mL, 120 mm	0030 000.978		
			
<b>violet</b>	300 tips (3 bags × 100 tips)		
0.2 – 5 mL L, 175 mm	0030 000.650		
			
<b>turquoise</b>	200 tips (2 bags × 100 tips)		
0.5 – 10 mL, 165 mm	0030 000.765		
			
<b>turquoise</b>	200 tips (2 bags × 100 tips)		
0.5 – 10 mL L, 243 mm	0030 000.781		
			

(Image reduced size)

\* not available before May 2018

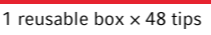
## Liquid Handling

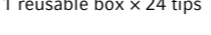
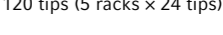
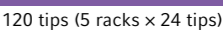
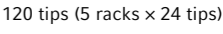







Box	Set	Singles	Racks
1 reusable box × 96 tips			480 tips (5 racks × 96 tips)
0030 073.657*			0030 075.161*
			
1 reusable box × 48 tips	240 tips (5 trays × 48 tips), 1 reusable box		240 tips (5 racks × 48 tips)
0030 073.150*	0030 073.355*		0030 075.110*
			
1 reusable box × 24 tips			120 tips (5 racks × 24 tips)
0030 073.177*			0030 075.200*
			
			120 tips (5 racks × 24 tips)
			0030 075.218*
			
			120 tips (5 racks × 24 tips)
			0030 075.153*
			



## Liquid Handling

Volume range/ ep Dualfilter T.I.P.S.®/  
ep Dualfilter T.I.P.S.® LoRetention/  
ep Dualfilter T.I.P.S.® SealMax



	Racks PCR clean/Sterile (sterile and pyrogen-free)			Forensic DNA Grade
<b>dark gray</b>	960 tips (10 racks x 96 tips)			
0.1 – 10 µL S, 34 mm	0030 077.504	0030 077.610 LoRetention	0030 077.806 SealMax	
				
<b>medium gray</b>	960 tips (10 racks x 96 tips)			
0.1 – 10 µL M, 40 mm	0030 077.512			0030 077.768
				
<b>light gray</b>	960 tips (10 racks x 96 tips)			
0.5 – 20 µL L, 46 mm	0030 077.520	0030 077.628 LoRetention	0030 077.814 SealMax	
				
<b>yellow</b>	960 tips (10 racks x 96 tips)			
2 – 20 µL, 53 mm	0030 077.539			0030 077.776
				
<b>yellow</b>	960 tips (10 racks x 96 tips)			
2 – 100 µL, 53 mm	0030 077.547	0030 077.644 LoRetention	0030 077.822 SealMax	
				
<b>yellow</b>	960 tips (10 racks x 96 tips)			
2 – 200 µL, 55 mm	0030 077.555		0030 077.830 SealMax	0030 077.784
				
<b>orange</b>	960 tips (10 racks x 96 tips)			
20 – 300 µL, 55 mm	0030 077.563	0030 077.636 LoRetention	0030 077.849 SealMax	
				
<b>blue</b>	960 tips (10 racks x 96 tips)			
50 – 1,000 µL, 76 mm	0030 077.571	0030 077.652 LoRetention	0030 077.857 SealMax	0030 077.792
				
<b>dark green</b>	480 tips (5 racks x 96 tips)			
50 – 1,250 µL L, 103 mm	0030 077.750			
				



Technical specifications subject to change.

## Liquid Handling

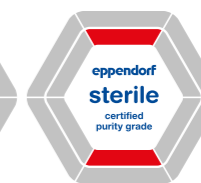

Volume range/ ep Dualfilter T.I.P.S.®/  
ep Dualfilter T.I.P.S.® LoRetention/  
ep Dualfilter T.I.P.S.® SealMax





	Racks PCR clean/Sterile (sterile and pyrogen-free)
<b>violet</b>	120 tips (5 racks x 24 tips)
0.1 – 5 mL, 120 mm	0030 077.580
	
<b>violet</b>	120 tips (5 racks x 24 tips)
0.2 – 5 mL L, 175 mm	0030 077.725
	
<b>turquoise</b>	100 tips, individually packed
0.5 – 10 mL L, 243 mm	0030 077.598
	

(Image reduced size)

## Special Tips



Volume range/ pipette tip

<b>light gray</b>	<b>Eppendorf GELoader®</b>
0.5 – 20 µL, 62 mm	192 tips (2 racks x 96 tips) 0030 001.222
	
<b>light gray</b>	<b>Microloader™</b>
0.5 – 20 µL, 100 mm	192 pcs. (2 racks x 96 pcs.) 5242 956.003
	
<b>light gray</b>	<b>Mastertip®</b>
20 µL, 52 mm	480 tips (5 racks x 96 tips) 0030 001.320
	

Your local distributor: [www.eppendorf.com/contact](http://www.eppendorf.com/contact)

Eppendorf AG · Barkhausenweg 1 · 22339 Hamburg · Germany · [eppendorf@eppendorf.com](mailto:eppendorf@eppendorf.com) · [www.eppendorf.com](http://www.eppendorf.com)



Eppendorf Reference® 2	0.1 – 10 µL S, dark gray	0.1 – 10 µL M, medium gray	0.1 – 20 µL medium gray	0.5 – 20 µL L, light gray	2 – 20 µL yellow	2 – 100 µL yellow	2 – 200 µL yellow	20 – 300 µL orange
epT.I.P.S.®	■	■	■	■	■	■	■	■
epT.I.P.S.® LoRetention	■		■	■			■	
ep Dualfilter T.I.P.S.®	■	■		■	■	■	■	■
ep Dualfilter T.I.P.S.® LoRetention	■			■		■		■
ep Dualfilter T.I.P.S.® SealMax	■			■		■	■	■
<b>Fixed volume</b>								
1 µL/2 µL	■	■	■					
5 µL/10 µL	■	■	■	■				
20 µL	■		■	■				
10 µL	■				■	■	■	
20 µL	■				■	■	■	■
25 µL/50 µL/100 µL	■					■	■	■
200 µL	■						■	■
200/ 250/ 500/ 1,000 µL	■							
2 mL/2.5 mL	■							
<b>Adjustable volume</b>								
0.1 – 2.5 µL	■	■	■					
0.5 – 10 µL	■	■	■	■				
2 – 20 µL	■	◆	◆	■				
2 – 20 µL	■				■	■	■	◆
10 – 100 µL	■				◆	■	■	■
20 – 200 µL	■				◆	◆	■	■
30 – 300 µL	■				◆	◆	◆	■
100 – 1,000 µL	■							
0.25 – 2.5 mL	■							
0.5 – 5 mL	■							
1 – 10 mL	■							

■ normal volume ◆ limited volume

50 – 1,000 µL blue	50 – 1,250 µL green	50 – 1,250 µL L, dark green	0.25 – 2.5 mL red	0.1 – 5 mL violet	0.2 – 5 mL L violet	0.5 – 10 mL turquoise	0.5 – 10 mL L turquoise	GEloader/ Microloader
■	■	■	■	■	■	■	■	■
■								
■								
■								
■								
■								
■								
■								
■								
■								
■								
■								
■								
■								
■								
■								
■								
■								
■								
■								

# Multipette® M4



## Product features

- > Repetitive dispensing modes decrease the number of movements by allowing the user to fill the tip once and dispense up to 100 times without a refill
- > Automatic Combitip recognition eliminates time consuming volume calculations
- > Wide dispensing range: 1 µL to 10 mL
- > Stress-free work via integrated step counter: dispensing procedures can be continued error-free after an interruption or distraction
- > Central Combitip ejector: fully emptied Combitip can be easily ejected with one hand
- > Perfect for viscous or foaming solutions and liquids with high vapour pressure through positive displacement principle
- > Safe handling of toxic, radioactive or infectious material

## Applications

- > Repetitive dispensing of volumes in long series such as tube or plate filling, aliquoting reagents and kit usage
- > Contamination-free dispensing of toxic, radioactive and other hazardous liquids
- > Precise and accurate dispensing of viscous solutions (e.g. glycerol) or liquids with high vapor pressure (e.g. ethanol)

Multipette M4 in combination with 9 different Combitips advanced volume sizes (0.1 mL – 50 mL) offers a unique volume range of 1 µL – 10 mL. The Combitip Rack features trouble-free and single-hand operation during dispensing work.



[www.eppendorf.com/m4-360](http://www.eppendorf.com/m4-360)

For more information go to [www.eppendorf.com](http://www.eppendorf.com)

Technical specifications subject to change.

Volume table for using the Combitips advanced with the Multipette M4

Position of the volume selection dial:										
	0.5	1	1.5	2	2.5	3	3.5	4	4.5	5
<b>Maximum number of dispensing steps:</b>										
	100	50	33	25	20	16	14	12	11	10
<b>Combitips advanced with the following dispensing volumes:</b>										
0.1 mL	1 µL	2 µL	3 µL	4 µL	5 µL	6 µL	7 µL	8 µL	9 µL	10 µL
0.2 mL	2 µL	4 µL	6 µL	8 µL	10 µL	12 µL	14 µL	16 µL	18 µL	20 µL
0.5 mL	5 µL	10 µL	15 µL	20 µL	25 µL	30 µL	35 µL	40 µL	45 µL	50 µL
1.0 mL	10 µL	20 µL	30 µL	40 µL	50 µL	60 µL	70 µL	80 µL	90 µL	100 µL
2.5 mL	25 µL	50 µL	75 µL	100 µL	125 µL	150 µL	175 µL	200 µL	225 µL	250 µL
5.0 mL	50 µL	100 µL	150 µL	200 µL	250 µL	300 µL	350 µL	400 µL	450 µL	500 µL
10 mL	100 µL	200 µL	300 µL	400 µL	500 µL	600 µL	700 µL	800 µL	900 µL	1.0 mL
25 mL <sup>1)</sup>	250 µL	500 µL	750 µL	1.0 mL	1.25 mL	1.5 mL	1.75 mL	2.0 mL	2.25 mL	2.5 mL
50 mL <sup>1)</sup>	500 µL	1.0 mL	1.5 mL	2.0 mL	2.5 mL	3.0 mL	3.5 mL	4.0 mL	4.5 mL	5.0 mL

<sup>1)</sup> 25 and 50 mL Combitips can only be used with the corresponding adapter. Further information about Combitips advanced see page 61.

Volume table for using the Combitips advanced with the Multipette M4

Position of the volume selection dial:										
	5.5	6	6.5	7	7.5	8	8.5	9	9.5	10
<b>Maximum number of dispensing steps:</b>										
	9	8	7	7	6	6	5	5	5	5
<b>Combitips advanced with the following dispensing volumes:</b>										
0.1 mL	11 µL	12 µL	13 µL	14 µL	15 µL	16 µL	17 µL	18 µL	19 µL	20 µL
0.2 mL	22 µL	24 µL	26 µL	28 µL	30 µL	32 µL	34 µL	36 µL	38 µL	40 µL
0.5 mL	55 µL	60 µL	65 µL	70 µL	75 µL	80 µL	85 µL	90 µL	95 µL	100 µL
1.0 mL	110 µL	120 µL	130 µL	140 µL	150 µL	160 µL	170 µL	180 µL	190 µL	200 µL
2.5 mL	275 µL	300 µL	325 µL	350 µL	375 µL	400 µL	425 µL	450 µL	475 µL	500 µL
5.0 mL	550 µL	600 µL	650 µL	700 µL	750 µL	800 µL	850 µL	900 µL	950 µL	1.0 mL
10 mL	1.1 mL	1.2 mL	1.3 mL	1.4 mL	1.5 mL	1.6 mL	1.7 mL	1.8 mL	1.9 mL	2.0 mL
25 mL <sup>1)</sup>	2.75 mL	3.0 mL	3.25 mL	3.5 mL	3.75 mL	4.0 mL	4.25 mL	4.50 mL	4.75 mL	5.0 mL
50 mL <sup>1)</sup>	5.5 mL	6.0 mL	6.5 mL	7.0 mL	7.5 mL	8.0 mL	8.5 mL	9.0 mL	9.5 mL	10 mL

<sup>1)</sup> 25 and 50 mL Combitips can only be used with the corresponding adapter. Further information about Combitips advanced see page 61.

## Ordering information

Description	Order no.
Multipette® M4, single-channel, 1 µL – 10 mL	4982 000.012
Multipette® M4 Starter Kit, single-channel, Multipette® M4, Combitip Rack, Combitip assortment pack, 1 µL – 10 mL	4982 000.314
Battery, 3 V, for Multipette® M4 and Multipette® plus	4980 215.003

Your local distributor: [www.eppendorf.com/contact](http://www.eppendorf.com/contact)

Eppendorf AG · Barkhausenweg 1 · 22339 Hamburg · Germany · [eppendorf@eppendorf.com](mailto:eppendorf@eppendorf.com) · [www.eppendorf.com](http://www.eppendorf.com)

# Multipette® E3/E3x



## Product features

- > Automatic Combitip recognition: Eliminates time consuming volume calculations, avoiding incorrect dispensing volumes
- > Ergonomic one-button tip ejector: For one handed operation and contact-free Combitips advanced ejection
- > Speed Adjustment: Program aspiration and dispensing speed for the utmost in precision and accuracy while also preventing splashing
- > Repetitive dispensing modes: Decrease the number of movements for the user by allowing them to fill the tip once and dispense up to 100 times without a refill
- > Wide dispensing range: 1 µL to 50 mL provides up to 5,000 dispensing volumes with increments as low as 100 nanoliters
- > Motor driven function reduces the human error to a minimum and reduces risk of repetitive strain injuries (RSI)
- > Safe and ergonomic operation with 9 different selectable languages
- > Large illuminated color display reduces eye strain when reading
- > Positive displacement system: Not affected by liquid properties, most manual pipetting errors and provides protection from aerosol contamination
- > Eppendorf TrackIT compatible: Editable data chip contains all relevant information. [www.eppendorf.com/trackit](http://www.eppendorf.com/trackit)

## Applications

- > Repetitive dispensing of volumes in long series such as tube or plate filling, aliquoting reagents and kit usage (Dispensing/Automatic Dispensing modes)
- > Contamination-free dispensing for toxic, radioactive and other hazardous liquids (all available modes)
- > Precise and accurate dispensing of viscous solutions (e.g. glycerol) or liquids with high vapor pressure (e.g. ethanol) (all available modes)
- > Pooling of supernatants (Aspiration mode)
- > Creation of dilution series (Sequential Dispensing mode)
- > Concentration Determination (Titration mode)
- > Pooling and volume determination with subsequent dispensing (Aspirate and Dispense mode)



## Work precisely and safely

The optimized system of Multipette and Combitips® advanced allows automatic tip recognition for ease of use. The syringe style Combitip maximizes pipetting accuracy and precision. It is not affected by liquid properties, most manual pipetting errors and provides protection from aerosol contamination.



[www.eppendorf.com/multipette-system](http://www.eppendorf.com/multipette-system)

> Further information about Combitips advanced see on page 61

Multipette E3 and Multipette E3x at a glance	Multipette E3	Multipette E3x
High speed dispensing with motorized piston	■	■
Automatic Combitips advanced® tip recognition	■	■
One button tip ejection	■	■
Volume range from 1 µL to 50 mL, over 5,000 possible dispensing volumes	■	■
Big illuminated color display in 9 languages	■	■
Sleep mode saves battery when not in use	■	■
Long life Li-ion battery	■	■
Speed adjustment to match the viscosity of your liquid and the size of your vessel to prevent air bubbles and splashing	■	■
<b>Options (Opt):</b> Save favorite settings, set service intervals, activate key lock and more	■	■
Modes of operation	3	7
Pipetting (Pip): Precise liquid transfer of up to 50 mL	■	■
Dispensing (Dis): Serial dispensing for up to 100 steps in a row	■	■
Automatic dispensing (Ads): Volume is dispensed at fixed intervals between 0.1 s and 10 s	■	■
Sequential dispensing (Seq): Individual volume setting for up to 16 dispensing steps	■	■
Aspirate (Asp): consecutive aspiration of liquid for pooling into one Combitip	■	■
<b>Aspirate and Dispense (A/D):</b> Uptake and volume calculation of an unknown volume with immediate dispense in desired partial volumes	■	■
Titration (Tit): Sensitive dosing of liquids while dispensed volume is measured	■	■

## Ordering information

Description	Order no.
<b>Multipette® E3</b> , single-channel, with charging cable and Combitips advanced® assortment pack (1 Combitip of each size), 1 µL – 50 mL	4987 000.010
<b>Multipette® E3 bundle incl. charger stand</b> , single-channel, with charging cable and Combitips advanced® assortment pack (1 Combitip of each size), 1 µL – 50 mL	4987 000.371
<b>Multipette® E3x</b> , single-channel, with charging cable and Combitips advanced® assortment pack (1 Combitip of each size), 1 µL – 50 mL	4987 000.029
<b>Multipette® E3x bundle incl. charger stand</b> , single-channel, with charging cable and Combitips advanced® assortment pack (1 Combitip of each size), 1 µL – 50 mL	4987 000.380
<b>Spare charging cable</b> , for Eppendorf Xplorer®, electronic Multipette®, and charger stand	4986 603.005



## NEW – ViscoTip™

### Description

Experience the new member of the Combitips advanced® dispenser tip family. The ViscoTip is specifically designed and optimized for handling high viscosity liquids up to 14,000 mPa\*s such as Glycerol 99.5%, Tween, oils, cremes, shampoos or honey. It sharply reduces operating forces while handling such liquids leading to enhanced ergonomics, increased working speed and longer charge life time of your Multipipette battery.



1. The optimized geometry sharply reduces operating forces. It allows manual handling of liquids which otherwise would be too viscous for dispensing.

2. The tip allows dispensing volumes in a range from 100 µL up to 10 mL with increments of 10 microliters.

3. An adjusted volume scale and a color coded double ring allow instant identification of the tip.

### Applications

- > Positive displacement principle (comparable to a syringe)
- > High viscosity liquids with dynamic viscosities of 300 to 14,000 mPa\*s
- > Provides protection from radioactive and toxic substances



## Eppendorf Combitips advanced®

### Description

In 1978 Eppendorf revolutionized the industry and laboratory workflow with the introduction of the Combitip/Multipipette system and has been the leader in market innovations for more than 38 years. The Eppendorf Combitips advanced have been completely redesigned and optimized to meet all the needs of any modern laboratory. The Combitips advanced also function according to the positive displacement principle, thus they always dispense the correct volume independently of the density of the liquid and its flow characteristics (e.g., increased vapor pressure or increased viscosity). Working with radioactive or toxic materials also becomes safer due to the hermetically sealed piston preventing aerosol contamination.



### Product features

- > Combitips advanced are the ideal system components for all Eppendorf Multipipettes
- > The 9 volume sizes (0.1 mL – 50 mL) offer a maximum range of dispensing volumes with increments as low as 100 nanoliters depending on the Combitip used
- > Elongated Combitips in volumes 2.5 mL, 5.0 mL and 10 mL make it possible to reach the bottom of the most common laboratory vessels
- > An individual color coding facilitates the quick identification of the desired Combitips
- > The unique funnel geometry ensures comfortable handling while preventing damage to gloves
- > Combitips advanced are offered in 4 different purity grades to support a range of applications
- > The appropriate purity grade for each application: Eppendorf Quality™, PCR Clean, Forensic DNA Grade or Biopur®

### Applications

- > Positive displacement principle (comparable to a syringe)
- > High-precision dispensing regardless of the physical properties of the liquid (e.g., viscosity, volatility, density, temperature...)
- > Prevents aerosol contamination with hermetically sealed piston for secure dispensing
- > Provides protection from radioactive and toxic substances
- > Quick dispensing of long series with precise, repeated dispensing of identical volumes (with Multipipette hand dispensers)



### Always easy to reach

The new Combitip Rack features trouble-free and single-hand operation during dispensing work. The rack holds up to 8 Combitips advanced in sizes ranging from 0.1 mL to 10 mL. The transparent tray allows for the sizes of the Combitips to be easily identified using the color coding.

# Eppendorf Combitips advanced®



## Unmistakably Eppendorf

The Eppendorf Combitips advanced features the characteristic Eppendorf 3D design on the upper rim of the Combitip, allowing you to easily and confidently recognize the Eppendorf original!

## Variety and selection

4 purity grades (Eppendorf Quality, PCR clean, Eppendorf Biopur® and Eppendorf Forensic DNA Grade) are available, so that you will always find the perfect Combitip for your application! The Eppendorf Biopur and Forensic DNA Grade Combitips advanced are individually blister-wrapped and feature an access tab which makes them easier to open, even with gloves!

## Technical Specifications

Eppendorf Combitips advanced®	Eppendorf Safe-Lock Tubes			Conical Tubes		Eppendorf Deepwell Plates		
	0.5 mL	1.5 mL	2.0 mL	15 mL	50 mL	96/500 µL	96/1000 µL	96/2000 µL
0.1 mL	+	+	+	-	-	+	+	+
0.2 mL	+	+	+	-	-	+	+	+
0.5 mL	+	+	+	-	-	+	+	+
1.0 mL	+	+	+	-	-	+	+	+
2.5 mL	++	++	++	++	++	+	++	++
5.0 mL	+	+	+	++	++	+	+	+
10 mL	+	+	+	-	++	+	+	+
25 mL	-	+	+	-	-	+	+	+
50 mL	-	+	+	-	-	+	+	+
ViscoTip™								
10 mL	+	+	+	-	++	+	+	+

++ = improved compatibility compared to Combitip plus generation



## Ordering information

Eppendorf Combitips advanced®	Color code	Eppendorf Quality™	PCR clean	Eppendorf Biopur®	Forensic DNA Grade
		<b>100 pcs. (4 bags × 25 pcs.)</b>	<b>100 pcs. (4 reclosable bags × 25 pcs.)</b>	<b>100 pcs., individually blister-wrapped</b>	<b>100 pcs., individually blister-wrapped</b>
0.1 mL	□ white	0030 089.405	0030 089.766	0030 089.618	
0.2 mL	■ light blue	0030 089.413	0030 089.774	0030 089.626	
0.5 mL	■ violet	0030 089.421	0030 089.782	0030 089.634	
1.0 mL	■ yellow	0030 089.430	0030 089.790	0030 089.642	0030 089.855
2.5 mL	■ green	0030 089.448	0030 089.804	0030 089.650	0030 089.863
5.0 mL	■ blue	0030 089.456	0030 089.812	0030 089.669	0030 089.871
10 mL	■ orange	0030 089.464	0030 089.820	0030 089.677	
25 mL <sup>1)</sup>	■ red	0030 089.472	0030 089.839	0030 089.685	
50 mL <sup>1)</sup>	■ light gray	0030 089.480	0030 089.847	0030 089.693	
<b>ViscoTip™</b>					
10 mL		0030 089.502			
<b>Accessories</b>					
<b>Adapter advanced</b>					
25 mL, autoclavable, 1 piece	■ red	0030 089.715			
25 mL, autoclavable, 7 pcs., individually wrapped	■ red			0030 089.731	
50 mL, autoclavable, 1 piece	■ light gray	0030 089.723			
50 mL, autoclavable, 7 pcs., individually wrapped	■ light gray			0030 089.740	
<b>Combitips advanced® Rack, for 8 Combitips advanced® (0.1 – 10 mL)</b>		0030 089.758			
<b>Combitips advanced® Assortment Pack, contains one sample of each size</b>		0030 089.936			

<sup>1)</sup> 4 boxes of 25 pcs. each. Each box containing one adapter.



[www.eppendorf.com/combitip-selection-guide/](http://www.eppendorf.com/combitip-selection-guide/)



## Varipette® 4720



### Description

The Eppendorf Varipette 4720 is a large volume pipette optimized for work with viscous or high-vapor pressure solutions. It also allows for aspirating liquids from large bottles or tall, narrow vessels when using the Varitip S system. Its super easy, one-hand operation significantly speeds up pipetting tasks: Simply press down the operating lever to aspirate liquid from the reservoir. Press the lever again and the liquid will be dispensed into your sample vessel.

### Product features

- > Volume range: 1 mL to 10 mL
- > Fast pipetting and convenient operation due to unique one-hand operation. Liquid automatically aspirates and dispenses by simply pressing the operating lever
- > 4-digit volume display and adjustable in 10 µL increments for accurate volume setting
- > Eppendorf Varitips® P (fig.1) is a syringe-style, positive displacement tip that allows for accurate pipetting of viscous solutions or liquids with high-vapor pressure
- > The Eppendorf Varitips® S system, consisting of the dispensing part (fig.2) and Maxitip (fig.3), is optimized for aspiration liquids from large bottles or tall, narrow vessels
- > The valve for use together with the Varitips® S system ensures drip-free dispensing of volatile solutions

Combination	Volume range	Volume	Rel. systematic error <sup>1)</sup>	Abs. systematic error <sup>1)</sup>	Rel. random error <sup>1)</sup>	Abs. random error <sup>1)</sup>
Varipette 4720 and Varitips S system	2.5 – 10 mL	2.5 mL	±1.0 %	0.025 mL	±0.2 %	0.005 mL
		5 mL	±0.4 %	0.02 mL	±0.2 %	0.01 mL
		10 mL	±0.3 %	0.03 mL	±0.2 %	0.02 mL
Varipette 4720 and Varitips P	1 – 10 mL	1 mL	±0.6 %	0.006 mL	±0.2 %	0.002 mL
		5 mL	±0.5 %	0.025 mL	±0.1 %	0.005 mL
		10 mL	±0.3 %	0.03 mL	±0.1 %	0.01 mL

<sup>1)</sup> The error data, according to EN ISO 8655, only apply if original Eppendorf tips are used. Technical specifications are subject to change. Errors and omissions excepted.

### Ordering information

Description	Order no.
<b>Varipette® 4720</b> , single-channel, with continuous volume selection in the 1 – 10 mL range, 1 – 10 mL	4720 000.011
<b>Varitips® P</b> , to remove liquid from smaller vessels, 100 pieces	0030 048.130
<b>Eppendorf Varitips® S Starter Kit</b> , to remove liquid from narrow-necked vessels and measuring flasks, consisting of 100 Maxitips, 10 dispensing parts, 10 valves	0030 050.525
<b>Eppendorf Varitips® S dispensing part</b> , 30 pieces	0030 050.533
<b>Eppendorf Varitips® S</b> , graduated, 200 pieces	0030 050.568
<b>Eppendorf Varitips® S valve</b> , 100 pieces	0030 050.541

## Eppendorf TrackIT



### Description

To increase the traceability of your pipette portfolio Eppendorf offers Eppendorf TrackIT. This product contains a RFID reader and software to scan the device data of an embedded RFID chip within liquid handling instruments and save it in a database which can be opened at any time.

### Applications

- > Instrument identification
- > Traceability of instruments used in an experiment
- > Individualization of the instrument
- > Printed documentation of all relevant instrument data
- > Make all relevant instrument information available for digital documentation
- > Documentation of service history

### Ordering information

Description	Order no.
<b>Eppendorf TrackIT</b> , RFID Reader and Software	3903 000.014

Technical specifications subject to change.

## Eppendorf Easypet® 3

### Description

Experience a new dimension of electronic pipetting with the Eppendorf Easypet 3. The latest technological developments give you complete speed control with the utmost precision. The lightweight, well-balanced Easypet 3 has been designed considering all ergonomic findings to fit comfortably in your hand and matches its shape to allow for fatigue-free pipetting.



### Product features

- > Intuitive and convenient speed adjustment simply done with the tips of your fingers
- > Lightweight, well-balanced and ergonomic design that allows for fatigue-free pipetting
- > Vibrant backlit LEDs provide optical feedback of the remaining battery life
- > Lithium polymer rechargeable battery offers long cordless runtime
- > Smooth setting of pump speed
- > Operation while recharging is possible
- > Autoclavable pipette adapter for sterile applications
- > Quick release of aspirating cone for easy exchange of membrane filters

### Applications

- > Pipette controller for use with pipettes from 0.1 – 100 mL
- > Serial dispensing of aliquots of different volumes
- > Resuspension of bacteria or cell pellets
- > Aspiration of cell layer from, e.g., Ficoll® gradient

### Technical specifications

Model	Eppendorf Easypet® 3
Weight	160 g
<b>Rechargeable battery</b>	
Capacity	1,100 mAh/3.7 V
Charging time	~3 h
Type	Lithium polymer
Number of dispensings	~2,000 (with a 25 mL pipette)
Operation	Electronic
Pipetting type	Air-cushion
<b>Mains/power supply</b>	
Input	100 V – 240 V AC ± 10 %, 50 Hz – 60 Hz, 0.5 A
Output	5 V DC, 1.0 A

### Ordering information

Description	Order no.
<b>Eppendorf Easypet® 3</b> , incl. mains/power supply device, wall mounting device, shelf stand, 2 membrane filters 0.45 µm, 0.1 – 100 mL	4430 000.018
<b>Membrane filter</b> , for Easypet® 4421 and Easypet® 3, 0.2 µm, sterile, PTFE, 5 pcs.	4430 606.005
<b>Membrane filter</b> , for Easypet® 4421 and Easypet® 3, 0.45 µm, sterile, PTFE, 5 pcs.	4421 601.009
<b>Li-polymer battery</b> , for Easypet® 3	4430 605.009



www.eppendorf.com/easypet-brochure

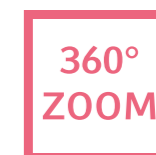

www.eppendorf.com/easypet-360

Your local distributor: [www.eppendorf.com/contact](http://www.eppendorf.com/contact)  
Eppendorf AG · Barkhausenweg 1 · 22339 Hamburg · Germany · [eppendorf@eppendorf.com](mailto:eppendorf@eppendorf.com) · [www.eppendorf.com](http://www.eppendorf.com)

# Eppendorf Serological Pipets

## Description

Eppendorf completes its portfolio in liquid handling with the new line of Eppendorf Serological Pipets. Experience the quality and convenience in liquid handling you have trusted in for decades with Eppendorf's system: Eppendorf Easypet® 3 and Eppendorf Serological Pipets.

Eppendorf's serological pipets are designed to work in perfect harmony with your Easypet 3. The pipets offer precise graduations overlaid on the ultra-clear pipet material to facilitate quick and easy reading of the volume. The pipets are individually wrapped and packaged in a robust dispenser box to ensure consistent premium quality.



## Product features

- > Clear and precise graduations for easy volume determination
- > Color-coding for easy identification of pipet sizes
- > Subunits with dispenser option to keep stored products safe
- > Individually wrapped pipets for reliable sterility
- > Ultra-pure virgin polystyrene meeting the requirement of USP VI
- > Harmonized and well-fitting operation with Easypet 3, compatibility with all existing pipet helper
- > Sterility assurance level of  $10^{-6}$
- > Certified absence of detectable pyrogens, DNA, RNase and DNase
- > Certified non-cytotoxic

## Ordering information

Description	Color code	Volume	Order no.
<b>Eppendorf Serological Pipets</b> , sterile, free of detectable pyrogens, DNA, RNase and DNase. Non-cytotoxic			
800 pcs. (4 bags × 200 pcs.)	yellow	1 mL	0030 127.692
600 pcs. (4 bags × 150 pcs.)	green	2 mL	0030 127.706
400 pcs. (4 bags × 100 pcs.)	blue	5 mL	0030 127.714
400 pcs. (4 bags × 100 pcs.)	orange	10 mL	0030 127.722
200 pcs. (4 bags × 50 pcs.)	red	25 mL	0030 127.730
160 pcs. (4 bags × 40 pcs.)	violet	50 mL	0030 127.749



[www.eppendorf.com/serolpip-360](http://www.eppendorf.com/serolpip-360)

# Eppendorf Pipet Helper®

## Description

The Eppendorf Pipet Helper in addition, is the perfect instrument for inexperienced users as its robust and intuitive design allows everybody to adjust the meniscus precisely. In addition the valve unit is optimized so that liquids can be drawn up simply, without exerting pressure. The aspiration bulb provides rapid filling of the pipet. The aspiration and dispensing of liquids are controlled gently by the ergonomic lever. Additionally a splash free blow-out is provided. The specially designed aspirating cone ensures secure seating for all measuring and volumetric pipets (glass and plastic).



## Product features

- > Lightweight with reduced operating force
- > Easy maintenance and cleaning due to easy disassembly, few parts and fully autoclavable
- > Comfortable working because of the good balance and pleasing material
- > The aspirating bulb enables pipetting of volumes up to 100 mL at once
- > Single lever controls low force aspirating and dispensing
- > High control over the liquid movement due to very sensitive valve unit
- > Drop wise dispensing and blow out without splashing
- > Drainage without any additional pressure delivers very reproducible results
- > Drip stop via hydrophobic membrane filter (3 µm)
- > The special silicon pipet adapter guarantees a secure pipette fit

## Applications

- > Preparation of a buffer for chromatography
- > Preparation of a fluid for fermentation
- > Sample transfer within petrochemistry
- > Generate a sample within water analytiks
- > Preparation of assays

## Ordering information

Description	Order no.
<b>Eppendorf Pipet Helper®</b> , 0.1 – 100 mL	4423 000.010
<b>Membrane filter</b> , for Eppendorf Pipet Helper®, 3 µm, not sterile	4423 601.014



[www.eppendorf.com/pipethelper-manual](http://www.eppendorf.com/pipethelper-manual)

For more information go to [www.eppendorf.com](http://www.eppendorf.com)

# NEW – Varispenser® 2/Varispenser® 2x

## Description

The new Eppendorf Varispenser 2 and Varispenser 2x are the ideal choice for dispensing aliquots of liquid from supply and reagent bottles. Advanced sealing lip technology enables dispensing of nearly all kinds of acids, solutions or bases. Available in 6 sizes for dispensing volumes from 0.2 – 100 mL, these instruments are designed to consistently dispense selected volumes without reagent waste. All Varispenser bottle top dispensers are fully autoclavable for maximum safety in your lab. The Varispenser 2x has a recirculation valve which prevents reagent loss while ventilating.



1. New! Safety valve balls in discharge valve close and prevent leakage when discharge tube is not mounted
2. New! Oval-shaped dispenser housing ensures safe grip during transportation and adjustment
3. New! Standard GL 45 thread on all sizes for most common bottle threads plus 3/5 adapters to cover additional bottle thread sizes
4. New! Air vent cap can be unscrewed for easy assembly of optional drying tube to protect sensitive reagent against humidity or CO<sub>2</sub>
5. PFA sealing lip technology prevents crystal building from media residue by wiping off the inner cylinder wall during dispensing
6. The fixation slide on the interior toothed track allows rapid and accurate volume adjustment and prevents accidental changes
7. Telescopic filling-tubes in several lengths allow use with bottles up to a height of 35 cm
8. The flexible discharge tube facilitates serial dispensing and filling of inflexible or distant vessels
9. The drying tube, filled with absorbing agent, protects reagent against humidity or CO<sub>2</sub>
10. Extra air vent cap with Luer-cone for assembly of microfilter available to prevent supply bottle contamination

## Ordering information

Volume range	Volume	Dispensing step	Rel. systematic error <sup>1)</sup>	Abs. systematic error <sup>1)</sup>	Rel. random error <sup>1)</sup>	Abs. random error <sup>1)</sup>	Order no.
<b>Varispenser® 2</b> , bottle top dispenser with adapters GL 25, GL 28/S 28, GL 32, GL 38, S 40 and telescopic intake tube (length 125 – 240 mm)							
0.2 – 2 mL	0.2 mL	0.05 mL	±5 %	±10 µL	±1 %	±2 µL	4966 000.010
	1 mL	0.05 mL	±1 %	±10 µL	±0.2 %	±2 µL	
	2 mL	0.05 mL	±0.5 %	±10 µL	±0.1 %	±2 µL	
0.5 – 5 mL	0.5 mL	0.1 mL	±5 %	±25 µL	±1 %	±5 µL	4966 000.029
	2.5 mL	0.1 mL	±1 %	±25 µL	±0.2 %	±5 µL	
	5 mL	0.1 mL	±0.5 %	±25 µL	±0.1 %	±5 µL	
1 – 10 mL	1 mL	0.2 mL	±5 %	±50 µL	±1 %	±10 µL	4966 000.037
	5 mL	0.2 mL	±1 %	±50 µL	±0.2 %	±10 µL	
	10 mL	0.2 mL	±0.5 %	±50 µL	±0.1 %	±10 µL	
<b>Varispenser® 2</b> , bottle top dispenser with adapters GL 32, GL 38, S 40 and telescopic intake tube (length 170 – 330 mm)							
2.5 – 25 mL	2.5 mL	0.5 mL	±5 %	±120 µL	±1 %	±25 µL	4966 000.045
	12.5 mL	0.5 mL	±1 %	±120 µL	±0.2 %	±25 µL	
	25 mL	0.5 mL	±0.5 %	±120 µL	±0.1 %	±25 µL	
5 – 50 mL	5 mL	1 mL	±5 %	±250 µL	±1 %	±50 µL	4966 000.053
	25 mL	1 mL	±1 %	±250 µL	±0.2 %	±50 µL	
	50 mL	1 mL	±0.5 %	±250 µL	±0.1 %	±50 µL	
10 – 100 mL	10 mL	1 mL	±5 %	±500 µL	±1 %	±100 µL	4966 000.061
	50 mL	1 mL	±1 %	±500 µL	±0.2 %	±100 µL	
	100 mL	1 mL	±0.5 %	±500 µL	±0.1 %	±100 µL	
<b>Varispenser® 2x</b> , bottle top dispenser with recirculation valve with adapters GL 25, GL 28/S 28, GL 32, GL 38, S 40 and telescopic intake tube (length 125 – 240 mm)							
2 mL	0.2 mL	0.5 mL	±5 %	±10 µL	±1 %	±2 µL	4967 000.014
	1 mL	0.5 mL	±1 %	±10 µL	±0.2 %	±2 µL	
	2 mL	0.5 mL	±0.5 %	±10 µL	±0.1 %	±2 µL	
0.5 – 5 mL	0.5 mL	0.1 mL	±5 %	±25 µL	±1 %	±5 µL	4967 000.022
	2.5 mL	0.1 mL	±1 %	±25 µL	±0.2 %	±5 µL	
	5 mL	0.1 mL	±0.5 %	±25 µL	±0.1 %	±5 µL	
0.1 – 10 mL	1 mL	0.2 mL	±5 %	±50 µL	±1 %	±10 µL	4967 000.030
	5 mL	0.2 mL	±1 %	±50 µL	±0.2 %	±10 µL	
	10 mL	0.2 mL	±0.5 %	±50 µL	±0.1 %	±10 µL	
<b>Varispenser® 2x</b> , bottle top dispenser with recirculation valve with adapters GL 32, GL 38, S 40 and telescopic intake tube (length 170 – 330 mm)							
2.5 – 25 mL	2.5 mL	0.5 mL	±5 %	±120 µL	±1 %	±25 µL	4967 000.049
	12.5 mL	0.5 mL	±1 %	±120 µL	±0.2 %	±25 µL	
	25 mL	0.5 mL	±0.5 %	±120 µL	±0.1 %	±25 µL	
5 – 50 mL	5 mL	1 mL	±5 %	±250 µL	±1 %	±50 µL	4967 000.057
	25 mL	1 mL	±1 %	±250 µL	±0.2 %	±50 µL	
	50 mL	1 mL	±0.5 %	±250 µL	±0.1 %	±50 µL	
10 – 100 mL	10 mL	1 mL	±5 %	±500 µL	±1 %	±100 µL	4967 000.065
	50 mL	1 mL	±1 %	±500 µL	±0.2 %	±100 µL	
	100 mL	1 mL	±0.5 %	±500 µL	±0.1 %	±100 µL	

<sup>1)</sup> The data for systematic error and random error are given according to EN ISO 8655. Technical specifications are subject to change. Errors and omissions excepted. The Varispenser (plus) is not a substitution for a bottle closure. Volatile liquids can disappear.



# Eppendorf Top Buret™

## Description

The Eppendorf Top Buret sets standards for manual titration. With each turn of the dial, liquid is continuously dispensed. This eliminates the need for new liquid aspiration and makes titration simpler and safer. The Top Buret comes in two different models: Model M features a dispensing rate of 2,500 µL per rotation; Model H features a rate of 5,000 µL per rotation. The digital display readings on both models range from 10 µL to 999.9 mL with the size of your supply bottle being the only limiting factor. It's clearly labeled user-friendly digital display and simple knob control provides for easy, ergonomic and fatigue free operation.



## Product features

- > Continuous, pulse-free dispensing technology
- > Recirculation valve with valve lever
- > Voltage supply with long-life battery and battery status indicator
- > Dispensing range 0.1 mL to 999.9 mL
- > Electronic control pad can be removed as unit
- > Service-friendly modular design incl. simple calibration program
- > High chemical resistance
- > Variable discharge tube, horizontal 142 – 220 mm, vertical 10 – 200 mm and rotatable by 360°
- > Telescopic aspirating tube for automatic length adjustment of 210 – 370 mm
- > Suitable for GL 32, GL 38, GL 45 and S 40 buttress thread with included adapters. Additional adapters available

## Ordering information

Volume range	Volume	Rel. systematic error <sup>1)</sup>	Abs. systematic error <sup>1)</sup>	Rel. random error <sup>1)</sup>	Abs. random error <sup>1)</sup>	Order no.
<b>Eppendorf Top Buret™ M</b>						
0.1 – 999.9 mL	2.5 mL 12.5 mL 25 mL	±2.0 % ±0.4 % ±0.2 %	±0.05 mL ±0.05 mL ±0.05 mL	±1.0 % ±0.2 % ±0.1 %	±0.025 mL ±0.025 mL ±0.025 mL	4965 000.017
<b>Eppendorf Top Buret™ H</b>						
0.1 – 999.9 mL	5 mL 25 mL 50 mL	±2.0 % ±0.4 % ±0.2 %	±0.1 mL ±0.1 mL ±0.1 mL	±1.0 % ±0.2 % ±0.1 %	±0.05 mL ±0.05 mL ±0.05 mL	4965 000.025

<sup>1)</sup> The data for systematic error and random error are given according to EN ISO 8655. Technical specifications are subject to change. Errors and omissions excepted. The Varispenser (plus) is not a substitution for a bottle closure. Volatile liquids can disappear.



[www.eppendorf.com/topburet-360](http://www.eppendorf.com/topburet-360)

## Accessories

Description	Order no.
<b>Telescoping aspirating tube from FEP</b> , individually adjustable length 125 mm – 240 mm, for Varispenser 2(x) with nominal volume of 2 mL, 5 mL or 10 mL, outer diameter 6 mm, standard size	4966 504.000
<b>Telescoping aspirating tube from FEP</b> , individually adjustable length 170 mm – 330 mm, for Varispenser 2(x) with nominal volume of 25 mL, 50 mL or 100 mL, outer diameter 7.6 mm, standard size	4966 507.000
<b>Telescoping aspirating tube from FEP</b> , individually adjustable length 195 mm – 350 mm, for Varispenser 2(x) with nominal volume of 2 mL, 5 mL or 10 mL, outer diameter 6 mm, special size for large cylinders	4966 505.007
<b>Telescoping aspirating tube from FEP</b> , individually adjustable length 250 mm – 480 mm, for Varispenser 2(x) with nominal volume of 2 mL, 5 mL or 10 mL, outer diameter 6mm, special size for very large cylinders and canisters	4966 506.003
<b>Telescoping aspirating tube from FEP</b> , individually adjustable length 250 mm – 480 mm, for Varispenser 2(x) with nominal volume of 25 mL, 50 mL or 100 mL, outer diameter 7.6 mm, special size for very large cylinders and canisters	4966 508.006
<b>Telescoping aspirating tube from FEP</b> , individually adjustable length 70 mm – 140 mm, for Varispenser 2(x) with nominal volume of 2 mL, 5 mL or 10 mL, outer diameter 6 mm, special size for small cylinders	4966 503.004
<b>Telescopic aspirating tube</b> , for Eppendorf Top Buret™, Varispenser® and Varispenser® plus	4960 805.009
<b>Bottle thread adapter from GL 32 to GL 25, PP</b>	4960 800.040
<b>Bottle thread adapter from GL 32 to GL 27, PP</b>	4960 800.139
<b>Bottle thread adapter from GL 32 to GL 28, PP</b>	4960 800.058
<b>Bottle thread adapter from GL 32 to NS 19/26, PP</b>	4960 800.082
<b>Bottle thread adapter from GL 32 to NS 24/29, PP</b>	4960 800.090
<b>Bottle thread adapter from GL 32 to NS 29/32, PP</b>	4960 800.104
<b>Bottle thread adapter from GL 45 to GL 32, PP</b>	4960 800.120
<b>Bottle thread adapter from GL 45 to GL 38, PP</b>	4960 800.155
<b>Bottle thread adapter from GL 45 to S 40 (Buttress thread), PP</b>	4960 800.147
<b>Bottle thread adapter, from GL 32 to GL 28, ETFE</b>	4960 835.005
<b>Bottle thread adapter, from GL 45 to GL 38, ETFE</b>	4960 839.000
<b>Bottle thread adapter, from GL 45 to GL 40, ETFE</b>	4960 834.009
<b>Bottle thread adapter from GL 32 to GL 25, ETFE</b>	4966 614.000
<b>Bottle thread adapter from GL 45 to GL 32, ETFE</b>	4966 615.007
<b>Flexible discharge tube with recirculation valve, coiled from PTFE</b> , approx. 80 cm long, with safety hand grip, for Varispenser 2(x) with nominal volume of 2 mL, 5 mL or 10 mL, outer tube diameter 3 mm, inner tube diameter 2 mm	4966 501.001
<b>Flexible discharge tube with recirculation valve, coiled from PTFE</b> , approx. 80 cm long, with safety hand grip, for Varispenser 2(x) with nominal volume of 25 mL, 50 mL or 100 mL, outer tube diameter 4.5 mm, inner tube diameter 3 mm	4966 502.008
<b>Drying tube (not filled)</b> , including PTFE sealing ring, for Varispenser 2(x), all sizes	4966 509.002
<b>Drying tube</b> , without drying agent, for Eppendorf Top Buret™, Varispenser® and Varispenser® plus	4960 851.000
<b>Ventilation screw with Luer cone made of PP for microfilter</b> , including PTFE sealing ring, for Varispenser 2(x), all sizes	4966 511.007
<b>Thread adapter for jerrycan 5L from 45 mm to 17/8" thread</b>	4960 832.006



# epMotion® 96

## Description

Increase your productivity and pipet whole 96-well plates at once. Just make it faster and more precise. The epMotion 96 overcomes the limits of manual multichannel pipetting. Save time and money while getting better reproducibility of your results from cell-based assays, ELISA, cell seeding, nucleic acid quantification, plate reformatting, or other applications.



## Product features

- > 0.5 to 300 µL or 5 to 1,000 µL with one system
- > Electronic pipetting with synchronous 96 channel piston movement for better precision and reproducibility of results
- > Auto-detect function for tip size
- > Use two sizes of reload tips for best accuracy
- > Intuitive and industry proven software concept and convenient touch screen control
- > Intelligent, preset applications: aspiration, dilution, multi dispense, pipette and mix
- > Individual speed setting, set parameters you are comfortable with and that match the liquid class
- > Easy and rapid tip load and reloading
- > Compact design to fit in a the laminar flow hood
- > Reduced risk of repetitive stress injury (RSI)

## Applications

- > Replication and reformatting of microplates
- > PCR set-up in 96 well format
- > Cell seeding and media change
- > Reagent and compound addition
- > 384 wells by 4 times 96 well pipetting
- > Cell-based assays
- > ELISA handling (plate coating and wash)
- > Biochemical assays
- > Nucleic acid purification in 96-well format

For more information go to [www.eppendorf.com](http://www.eppendorf.com)

Technical specifications subject to change.



## Intuitive Operation

- > Software based on Eppendorf Xplorer® electronic pipettes provided as free Apple app
- > Intelligent, preset applications: aspiration, dilution, sequential dispensing, multi dispensing
- > Set individual parameters for aspiration or dispensing speed to match your current liquid class
- > Save frequently used volumes for quick programming
- > Possibility to program multi-step pipetting tasks for complex applications

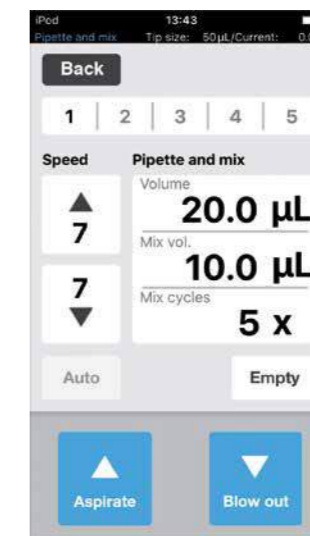
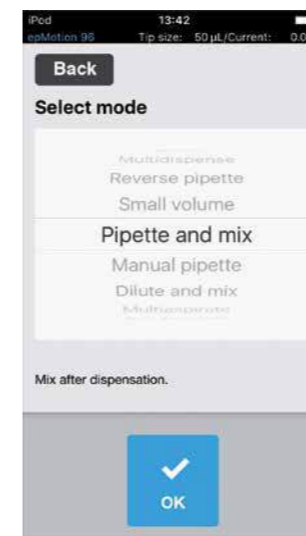

[www.eppendorf.com/epmotion96-brochure](http://www.eppendorf.com/epmotion96-brochure)

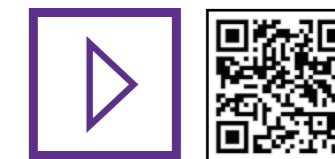

[www.eppendorf.com/epmotion96-video](http://www.eppendorf.com/epmotion96-video)

Technical specifications		
Model	epMotion® 96	epMotion® 96xl
Power supply	100 – 240 V ±10 %, 50 – 60 Hz ±5 %	100 – 240 V ±10 %, 50 – 60 Hz ±5 %
Max. power consumption	175 W	175 W
Dimensions (W x D x H)	22.9 x 45.7 x 53.3 cm / 9 x 18 x 21 in	22.9 x 45.7 x 53.3 cm / 9 x 18 x 21 in
Weight w/o accessories	19 kg / 42 lb	20 kg / 44 lb
<b>Dispensing tool</b>		
Random measurement error (1 µL)	≤3 % (1 µL with 50 µL tips)	≤3 % (5 µL with 300 µL tips)
Systematic measurement error (1 µL)	±2 % (1 µL with 50 µL tips)	±2 % (5 µL with 300 µL tips)
Random measurement error (10 µL)	≤3 % (10 µL with 300 µL tips)	≤3 % (10 µL with 1,000 µL tips)
Systematic measurement error (10 µL)	±2 % (10 µL with 300 µL tips)	±2 % (10 µL with 1,000 µL tips)
<b>Operation</b>		
Pipetting type	Air-cushion	Electronic
SLAS/ANSI deck positions	1 (2)	1 (2)

## Ordering information

Description	Order no.
epMotion® 96, semi-automated electronic pipette for parallel 96 channel microplate processing (without iPod® controller), 100 – 240 V ±10 %/50 – 60 Hz ±5 %, 0.5 – 300 µL	5069 000.012
epMotion® 96 with 2-position slider, semi-automated electronic pipette for parallel 96 channel microplate processing (without iPod® controller), 100 – 240 V ±10 %/50 – 60 Hz ±5 %, 0.5 – 300 µL	5069 000.110
epMotion® 96xl, semi-automated electronic pipette for parallel 96 channel microplate processing (without iPod® controller), 100 – 240 V ±10 %/50 – 60 Hz ±5 %, 5 – 1,000 µL	5069 000.217
epMotion® 96xl with 2-position slider, semi-automated electronic pipette for parallel 96 channel microplate processing (without iPod® controller), 100 – 240 V ±10 %/50 – 60 Hz ±5 %, 5 – 1,000 µL	5069 000.314
epMotion® 96 Accessories, Upgrade set 2-position slider for epMotion® 96, 0.5 – 300 µL	5069 074.008

Ordering information for other voltage options begins on page 434

Your local distributor: [www.eppendorf.com/contact](http://www.eppendorf.com/contact)  
Eppendorf AG · Barkhausenweg 1 · 22339 Hamburg · Germany · [eppendorf@eppendorf.com](mailto:eppendorf@eppendorf.com) · [www.eppendorf.com](http://www.eppendorf.com)

## epMotion® 5070/5070f

**Product features**

- > 4 ANSI/SLAS worktable and unlimited virtual positions
- > Maximum pipetting accuracy from 0.2 to 1,000 µL
- > Calibrated 1-channel and 8-channel pipetting tools
- > Optical sensor<sup>1)</sup> for detecting liquids, labware, tips
- > Compatible with tubes (0.2 mL to 50 mL) and microplates with up to 384 wells
- > Automatic exchange of two pipetting tools
- > User guided LH assistant for general Liquid Handling tasks
- > Completely contained housing including door safety mechanism (except for 5070f, laminar-flow version)
- > Option for compact EasyCon tablet or MultiCon PC controller by touch, mouse or keyboard, upgradable for barcode tracking and GxP software versions

<sup>1)</sup> Patent US 6,819,437 B2

**Applications**

- > Serial dilutions
- > Distributing reagents
- > Assay set-up
- > Sample transfer from individual tubes to plates
- > Reformatting plates
- > PCR set-up
- > Cell-based assay set-up
- > Immunoassay set-up
- > Setting concentrations or volumes
- > Media change

**Special features for epMotion 5070f**

- > Eppendorf Light barrier beam – monitors the closure of the bench hood for safety
- > Pre-programmed cell culture labware
- > Sterile pipet tips available
- > Autoclavable pipetting tools



[www.eppendorf.com/epmotion5070-brochure](http://www.eppendorf.com/epmotion5070-brochure)

**i** For more information go to [www.eppendorf.com](http://www.eppendorf.com)

## epMotion® 5073l/5073m

**Product features**

- > 6 ANSI/SLAS microplate positions
- > Software assistants for simple, step-by-step application programming
- > Optical sensor<sup>1)</sup> for detecting liquids, labware, tips
- > Automatic replacement of 2 pipetting tools and gripper
- > Volume range of 0.2 to 1,000 µL for maximum pipetting accuracy
- > 3D-MagSep technology, mixing, tempering, and magnetic separation all at one location
- > Calibrated 1-channel and 8-channel pipetting tools
- > Optional UV lamp and HEPA filter system for decontamination and clean air conditions
- > Compatible with tubes (0.2 to 50 mL) and microplates with up to 384 wells

<sup>1)</sup> US patent 6,819,437 B2

**Applications**

- > DNA and RNA purification
- > PCR set-up
- > Serial dilution and normalization of samples
- > Sample or reagent transfer
- > Sample mixing and tempering
- > Assay set-up
- > Nucleic acid extraction
- > Media change and other cell culture applications

**Special features for epMotion 5073**

- > The 6 positions of the epMotion® 5073 systems, automatic tool change, and gripper option open up a wide variety of applications
- > Unique combination of magnet finger module and Eppendorf ThermoMixer® allow you to separate, mixing and temper at one position (5073m)
- > Thermal module (optional) 5073l

## epMotion® 5075i

**Product features**

- > 15 ANSI/SLAS worktable positions
- > Maximum pipetting accuracy from 0.2 to 1,000 µL
- > Automatic exchange of all tools (gripper, 1-channel and 8-channel)
- > Optical sensor<sup>1)</sup> for detecting liquids, labware, tips
- > Compatible with tubes (0.2 mL to 50 mL) and microplates with up to 384 wells
- > Eppendorf MultiCon PC controller to run preinstalled LH assistant or epBlue software by touch or mouse
- > Optional software extensions for handling samples with barcodes or for integration to LIMS and ELN
- > Optional software extensions for supporting regulated process environments (GLP, GMP, 21 CFR part 11)
- > CleanCap option – UV lamp and HEPA filter for decontamination and clean air conditions
- > 3 thermal module options for heating or cooling (0 – 110 °C) of samples or reagents

**Applications**

- > NGS library preparation
- > Distributing reagents and serial dilutions
- > Sample transfer from individual tubes to plates
- > Reformatting plates
- > Media change and other cell culture applications
- > Sample pooling
- > Real-time PCR set-up
- > Cell-based assay set-up
- > Immunoassay set-up
- > Setting concentrations or volumes

<sup>i</sup> For more information go to [www.eppendorf.com](http://www.eppendorf.com)

## epMotion® 5075t/5075m

**Product features**

- > Same as 5075i, plus
- > Integrated Eppendorf ThermoMixer® with 2<sup>0</sup>Mix-Control technology
- > Temperature control range 15 °C below RT to 95 °C
- > Automatic fixing of labware for mixing up to 2,000 rpm
- > Pipetting at standard positions during shaking
- > 14.5 deck positions, 14 SLAS/ANSI plus small position for special reagent reservoir rack (3 reservoirs)
- > 2 thermal module options

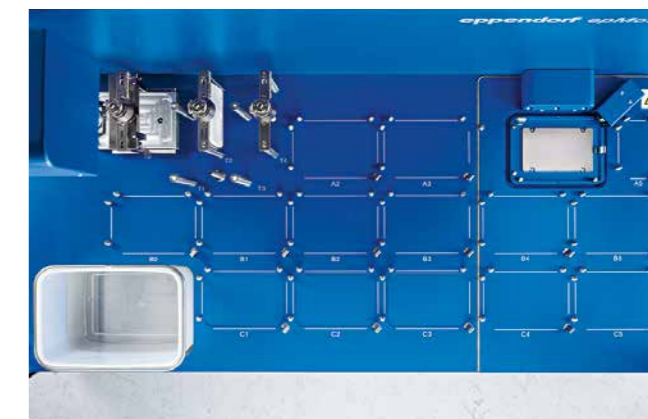
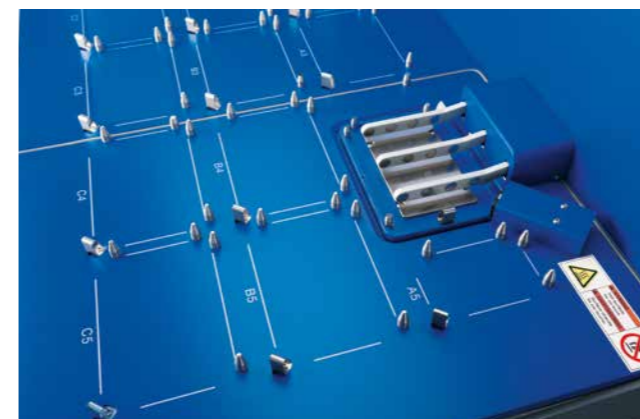
**Applications**

- > Like 5075i, plus
- > Bead applications with mixing and tempering
- > Sequencing and PCR clean-up
- > Nucleic acid purification
- > Cell disruption
- > Immunoassays
- > NGS library preparation

**Special features for epMotion 5075m**

- > Same as epMotion 5075t, plus
- > Combination of magnetic finger module and Eppendorf ThermoMixer®
- > Dedicated MagSep reagent kits for nucleic acid purification from 1 – 24 samples
- > 3 × Prep assistants for user guided automation of nucleic acid purification with MagSep kits
- > 4 × PCR assistants to streamline PCR set-up workflow

## epMotion® 5075v/5075vt

**Product features**

- > Same as epMotion 5075I
- > 12 SLAS/ANSI deck positions
- > Integrated vacuum pump – silent operation, no tubing, wiring, or reservoirs to maintain
- > Vacuum station fully integrated that automatically adapts to filter plates controlled by software
- > Gripper for plate and labware transport
- > 3 thermal module options (2 in case of 5075vt)
- > Also available as 5075vt version with integrated Eppendorf ThermoMixer®

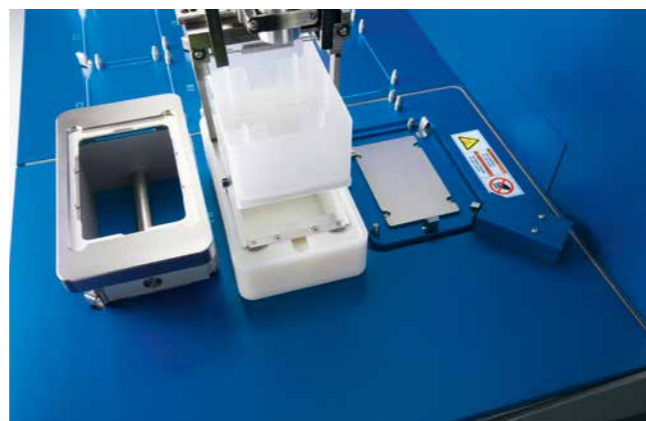
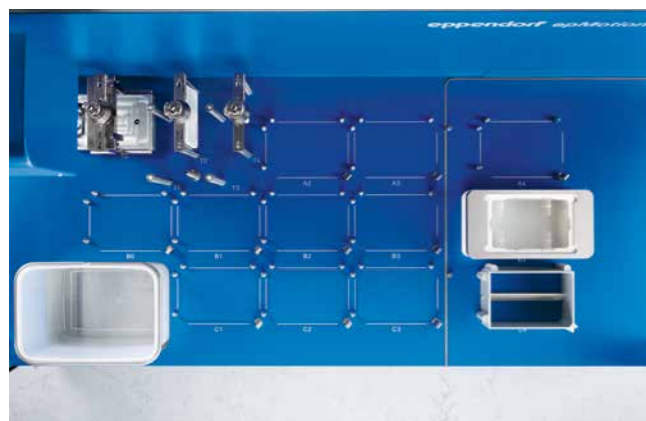
**Applications**

- > Like 5075I with vacuum purification technologies
- > Solid phase extraction
- > Filtration
- > DNA from blood, tissue and cells
- > DNA from plants and bacteria
- > Sequencing and PCR clean-up
- > Total RNA isolation

**Special features for epMotion 5075vt**

- > Integrated Eppendorf ThermoMixer® with 2D Mix-Control technology
- > Temperature control range RT -15 °C to 95 °C
- > Automatic securing of labware for mixing up to 2,000 rpm

For more information go to [www.eppendorf.com](http://www.eppendorf.com)

Technical specifications subject to change.

**Ordering information**

Description	Order no.
epMotion® 5070 EasyCon, completely contained housing, system incl. EasyCon, epBlue™ software and LH assistant, mouse, waste box, 100 – 240 V ±10 %/50 – 60 Hz ±5 %, 0.2 µL – 1 mL	5070 006.032
epMotion® 5070 MultiCon, completely contained housing, system incl. MultiCon, epBlue™ software and LH assistant, keyboard, mouse, waste box, 100 – 240 V ±10 %/50 – 60 Hz ±5 %, 0.2 µL – 1 mL	5070 000.282
epMotion® 5070f EasyCon, system incl. EasyCon, epBlue™ software and LH assistant, mouse, waste box, 100 – 240 V ±10 %/50 – 60 Hz ±5 %, 0.2 µL – 1 mL	5070 006.108
epMotion® 5070f MultiCon, system incl. MultiCon, epBlue™ software and LH assistant, keyboard, mouse, waste box, 100 – 240 V ±10 %/50 – 60 Hz ±5 %, 0.2 µL – 1 mL	5070 000.283
epMotion® 5073m EasyCon, completely contained housing, system incl. EasyCon, Eppendorf MagSep™ module, Eppendorf ThermoMixer®, epBlue™ software and Prep assistant, mouse, waste box, 100 – 240 V ±10 %/50 – 60 Hz ±5 %, 0.2 µL – 1 mL	5073 000.787
epMotion® 5073m MultiCon, completely contained housing, system incl. MultiCon, Eppendorf MagSep™ module, Eppendorf ThermoMixer®, epBlue™ software and Prep assistant, keyboard, mouse, waste box, 100 – 240 V ±10 %/50 – 60 Hz ±5 %, 0.2 µL – 1 mL	5073 000.795
epMotion® 5073mc EasyCon, CleanCap, system incl. EasyCon, Eppendorf MagSep™ module, Eppendorf ThermoMixer®, CleanCap, epBlue™ software and Prep assistant, mouse, waste box, 100 – 240 V ±10 %/50 – 60 Hz ±5 %, 0.2 µL – 1 mL	5073 000.809
epMotion® 5073mc MultiCon, CleanCap, system incl. MultiCon, MagSep™ module, ThermoMixer®, CleanCap, epBlue™ software and Prep assistant, keyboard, mouse, waste box, 100 – 240 V ±10 %/50 – 60 Hz ±5 %, 0.2 µL – 1 mL	5073 000.817
epMotion® M5073, completely contained housing, system incl. EasyCon, MagSep™ module, ThermoMixer®, epBlue™ software and Prep assistant, TS 50, TS 1000, PrepRack, ReagentRack, Rack for 24 Safe-Lock Tubes, mouse, waste box, 100 – 240 V ±10 %/50 – 60 Hz ±5 %, 0.2 µL – 1 mL	5073 000.205
epMotion® M5073c, with CleanCap, EasyCon, MagSep™ module, ThermoMixer®, epBlue™ software and Prep assistant, TS 50, TS 1000, PrepRack, ReagentRack, Rack for 24 Safe-Lock Tubes, mouse, waste box, 100 – 240 V ±10 %/50 – 60 Hz ±5 %, 0.2 µL – 1 mL	5073 000.400
epMotion® 5073I EasyCon, completely contained housing system incl. EasyCon, epBlue™ software and LH assistant, mouse, waste box, 100 – 240 V ±10 %/50 – 60 Hz ±5 %, 0.2 µL – 1 mL	5073 000.582
epMotion® 5073I MultiCon, completely contained housing system incl. MultiCon, epBlue™ software and LH assistant, keyboard, mouse, waste box, 100 – 240 V ±10 %/50 – 60 Hz ±5 %, 0.2 µL – 1 mL	5073 000.590
epMotion® 5073Ic EasyCon, CleanCap, system incl. EasyCon, epBlue™ software and LH assistant, mouse, waste box, 100 – 240 V ±10 %/50 – 60 Hz ±5 %, 0.2 µL – 1 mL	5073 000.604
epMotion® 5073Ic MultiCon, CleanCap, system incl. MultiCon, epBlue™ software and LH assistant, keyboard, mouse, waste box, 100 – 240 V ±10 %/50 – 60 Hz ±5 %, 0.2 µL – 1 mL	5073 000.612
epMotion® P5073, for automatic preparation of PCR reactions, with EasyCon, epBlue™ software and PCR assistant, TS 50, TS 300, Thermoblock for PCR plates, 96 well, Rack for 24 Safe-Lock tubes, 100 – 240 V ±10 %/50 – 60 Hz ±5 %, 0.2 µL – 1 mL	5073 000.000
epMotion® P5073c, for automatic preparation of PCR reactions, with CleanCap, EasyCon, epBlue™ software and PCR assistant, TS 50, TS 300, Thermoblock for PCR plates, 96 well, Rack for 24 Safe-Lock tubes, 100 – 240 V ±10 %/50 – 60 Hz ±5 %, 0.2 µL – 1 mL	5073 000.302
epMotion® 5075I, basic device incl. epBlue™ software, mouse, waste box, 100 – 240 V ±10 %/50 – 60 Hz ±5 %, 0.2 µL – 1 mL	5075 000.301
epMotion® 5075v, basic device incl. vacuum system, gripper, vac frame 2, vac frame holder, epBlue™ software, mouse, waste box, 100 – 240 V ±10 %/50 – 60 Hz ±5 %, 0.2 µL – 1 mL	5075 000.303
epMotion® 5075t, basic device incl. Eppendorf ThermoMixer®, epBlue™ software, mouse, waste box, 100 – 240 V ±10 %/50 – 60 Hz ±5 %, 0.2 µL – 1 mL	5075 000.302
epMotion® 5075vt, basic device incl. vacuum system, gripper, vac frame 2, vac frame holder, Eppendorf ThermoMixer®, epBlue™ software, mouse, waste box, 100 – 240 V ±10 %/50 – 60 Hz ±5 %, 0.2 µL – 1 mL	5075 000.304
epMotion® 5075m, basic device incl. Eppendorf MagSep™ module, Eppendorf ThermoMixer®, epBlue™ software, mouse, waste box, 100 – 240 V ±10 %/50 – 60 Hz ±5 %, 0.2 µL – 1 mL	5075 000.305

Ordering information for other voltage options begins on page 434

Configuration option description	Ordering no.	5075I	5075t	5075v	5075vt	5075m
Eppendorf EasyCon™ tablet	5073 000.108	-	-	-	-	-
Eppendorf MultiCon PC controller incl. keyboard	5075 001.101	◆	◆	◆	◆	◆
Completely contained housing	5075 751.623	◆	◆	◆	◆	◆
CleanCap & completely contained housing	5075 751.607	opt.	opt.	opt.	opt.	opt.
Thermal module on position C1	5075 002.604	opt.	opt.	opt.	opt.	opt.
Thermal module on position C2	5075 002.612	opt.	opt.	opt.	opt.	opt.
Thermal module on position C3	5075 002.620	opt.	-	opt.	-	-
Gripper for labware transport, incl. holder	5282 000.018	opt.	opt.	incl.	incl.	opt.
epBlue™ ID, barcode & tracking software incl. manual barcode scanner	5075 002.701	opt.	opt.	opt.	opt.	opt.
epBlue™ GxP, software supporting regulatory compliance	5075 002.728	opt.	opt.	opt.	opt.	opt.
PCR assistance software	5075 002.515	opt.	opt.	opt.	opt.	incl.
Prep assistant software	5075 002.523	-	-	-	-	incl.
LH assistant software	5075 002.507	incl.	opt.	opt.	opt.	opt.

Legend ◆ Please add this option for working configuration

incl. Already included in this basic epMotion device

- Selection of this option is not possible for this basic epMotion device

opt. Add this option to increase functionality of this basic epMotion device

Configuration options to be ordered with basic epMotion 5075 devices

Your local distributor: [www.eppendorf.com/contact](http://www.eppendorf.com/contact)

Eppendorf AG · Barkhausenweg 1 · 22339 Hamburg · Germany · [eppendorf@eppendorf.com](mailto:eppendorf@eppendorf.com) · [www.eppendorf.com](http://www.eppendorf.com)



## epT.I.P.S.<sup>®</sup> Motion pipette tips

### Description

Automated pipetting processes place high demands on the design and material of pipette tips used. Eppendorf has specially designed the epT.I.P.S. for use on the epMotion<sup>®</sup> 5070, 5073 and 5075 Liquid Handling Workstation. epT.I.P.S. Motion pipette tips, with and without filters, developed in torsion-resistant, clean racks.



### Product features

- > Color-coded trays for direct volume identification
- > Double O-ring on dispensing tools assures an optimal fit each time
- > Optical sensor automatically identified tip type

### Applications

- > Available in multiple purity grades
- > Easily exchangeable, no additional labware files required
- > Also available as reload system
- > Also available as epT.I.P.S. Motion SafeRacks recommended for re-use tips feature

## epT.I.P.S.<sup>®</sup> Motion as Reload System

### Description

epT.I.P.S. Motion can be used with epMotion 96 or integrated into your workstation as a reload system when combined with the tip holder. The high-quality reload tips are delivered in a PET thermoformed tray with sealed lid. Upgrading to the autoclavable, aluminum tip holder, which replaces the disposable box, provides waste reduction of up to 40 %.



### Product features

- > Delivered in a PET blister packaging with a sealed cap to assure quality
- > Color coded trays for easy volume identification
- > Reload system with autoclavable aluminum tip holder reduces plastic waste of tip boxes by up to 40 %
- > Available with standard and filter/PCR clean tips

### Applications

- > Easy conversion with TipHolder Adapter
- > TipHolder Adapter is autoclavable

### Ordering information

Description	Order no.
<b>epT.I.P.S.<sup>®</sup> Motion as Reload System, without filter</b>	
Eppendorf Quality <sup>™</sup> , 10 µL, 2,304 tips (24 trays × 96 tips)	0030 014.545
Eppendorf Quality <sup>™</sup> , 50 µL, 2,304 tips (24 trays × 96 tips)	0030 014.421
Eppendorf Quality <sup>™</sup> , 300 µL, 2,304 tips (24 trays × 96 tips)	0030 014.464
Eppendorf Quality <sup>™</sup> , 1,000 µL, 2,304 tips (24 trays × 96 tips)	0030 014.502
<b>epT.I.P.S.<sup>®</sup> Motion as Reload System, with filter</b>	
PCR clean, 10 µL, 2,304 tips (24 trays × 96 tips)	0030 014.553
PCR clean, 50 µL, 2,304 tips (24 trays × 96 tips)	0030 014.430
PCR clean, 300 µL, 2,304 tips (24 trays × 96 tips)	0030 014.472
PCR clean, 1,000 µL, 2,304 tips (24 trays × 96 tips)	0030 014.510
PCR clean and sterile, 10 µL, 2,304 tips (24 trays × 96 tips)	0030 014.561
PCR clean and sterile, 50 µL, 2,304 tips (24 trays × 96 tips)	0030 014.529
PCR clean and sterile, 300 µL, 2,304 tips (24 trays × 96 tips)	0030 014.537
<b>TipHolder, for epT.I.P.S.<sup>®</sup> Motion Reloads</b>	5075 751.399

### Ordering information

Description	Order no.
<b>epT.I.P.S.<sup>®</sup> Motion pipette tips, without filter</b>	
Sterile, 10 µL, 960 tips (10 racks × 96 tips)	0030 015.185
Sterile, 50 µL, 960 tips (10 racks × 96 tips)	0030 015.207
Sterile, 300 µL, 960 tips (10 racks × 96 tips)	0030 015.223
Sterile, 1,000 µL, 960 tips (10 racks × 96 tips)	0030 015.240
Eppendorf Quality <sup>™</sup> , 10 µL, 960 tips (10 racks × 96 tips)	0030 014.383
Eppendorf Quality <sup>™</sup> , 50 µL, 960 tips (10 racks × 96 tips)	0030 014.405
Eppendorf Quality <sup>™</sup> , 300 µL, 960 tips (10 racks × 96 tips)	0030 014.448
Eppendorf Quality <sup>™</sup> , 1,000 µL, 960 tips (10 racks × 96 tips)	0030 014.480
<b>epT.I.P.S.<sup>®</sup> Motion pipette tips, with filter</b>	
PCR clean and sterile, 10 µL, 960 tips (10 racks × 96 tips)	0030 015.193
PCR clean and sterile, 50 µL, 960 tips (10 racks × 96 tips)	0030 015.215
PCR clean and sterile, 300 µL, 960 tips (10 racks × 96 tips)	0030 015.231
PCR clean and sterile, 1,000 µL, 960 tips (10 racks × 96 tips)	0030 015.258
PCR clean, 10 µL, 960 tips (10 racks × 96 tips)	0030 014.391
PCR clean, 50 µL, 960 tips (10 racks × 96 tips)	0030 014.413
PCR clean, 300 µL, 960 tips (10 racks × 96 tips)	0030 014.456
PCR clean, 1,000 µL, 960 tips (10 racks × 96 tips)	0030 014.499
<b>epT.I.P.S.<sup>®</sup> Motion as SafeRack tips, without filter</b>	
Eppendorf Quality <sup>™</sup> , 50 µL, 960 tips (10 racks × 96 tips)	0030 014.600
Eppendorf Quality <sup>™</sup> , 300 µL, 960 tips (10 racks × 96 tips)	0030 014.626
Eppendorf Quality <sup>™</sup> , 1,000 µL, 960 tips (10 racks × 96 tips)	0030 014.642
<b>epT.I.P.S.<sup>®</sup> Motion as SafeRack tips, with filter</b>	
PCR clean, 50 µL, 960 tips (10 racks × 96 tips)	0030 014.618
PCR clean, 300 µL, 960 tips (10 racks × 96 tips)	0030 014.634
PCR clean, 1,000 µL, 960 tips (10 racks × 96 tips)	0030 014.650

## Software

**epBlue™ epMotion® PC software**

- > Graphical user interface
- > Main menu with direct access to the most important functions
- > 3D view of workstation and run simulation
- > User administration with password protection
- > Importing of files for normalization and cherry picking
- > Printing and archiving protocols
- > Pre-installed on all epMotion systems
- > Create, edit and simulate application on any Windows 7, 8 or 10 PC with epMotion Editor 40 software product

**epBlue™ ID software**

- > Visual tracking of the scan procedure
- > Automatic checking of the worktable
- > Scanning of individual reaction vessels and microplates
- > Documentation of reagent type and batch
- > CSV or XML-based results file
- > Compatible with LIMS-generated work lists
- > Data exchange with 2D barcode readers
- > Easy to operate

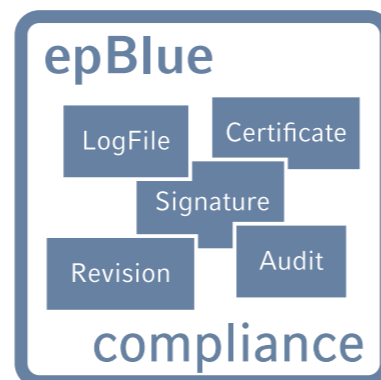
**epBlue™ GxP software**

- > Complete electronic documentation
- > Access control and user level management
- > Audit trail and log file
- > Revision management
- > Electronic signatures
- > Electronic certificates according to industry-standard algorithm
- > Exporting and archiving of digitally signed documents
- > Database system
- > Supplied certificates
- > Expansion via epBlue ID (optional)

**Ordering information**

Description	Order no.
<b>epBlue™ ID barcode and tracking software incl. manual barcode scanner</b> , modular expansion of epBlue™ for barcode support. Incl. manual barcode reader with stand. Compatible with epBlue™ version 40.1 and higher	5075 002.701
<b>epBlue™ GxP software</b> , for use in supporting process environments (according to GLP, GMP, 21 CFR part 11), as configuration option or for pre-installed epMotion® MultiCon versions with epBlue™ version 40.1 or higher, with epBlue™ GxP software, corresponding firmware, certificates	5075 002.728
<b>epMotion® Editor</b> , incl. editor key, software package for creating and editing applications, runs on the PC, compatible with epBlue™ 10.x versions	5075 014.009
<b>epMotion® Editor</b> , incl. editor key, for creating and editing applications, runs on the PC, compatible with epBlue™ 10.x versions, additional license	5075 015.200
<b>epMotion® Editor</b> , epMotion® Editor 40, software CD ROM with instructions, used to create, edit and simulate application on a PC, compatible with epBlue™ version >40.x	5075 014.220
<b>epMotion® Editor 40</b> , additional software license	5075 014.300
<b>epBlue™ ID software and hardware modification kit</b> , for 5070 and 5075 PC versions, barcode support includes software, barcode reader and stand, compatible with all epMotion® PC versions except epMotion® 5075 MC PC version, not compatible with the epMotion® operator panel versions	5075 000.830

## epMotion® Accessories

**Dispensing tools**

- > 8 dispensing tools from 0.2 µL to 1,000 µL are available
- > 4 single channel and 4 multi channel
- > Autoclavable and calibrated based on ISO 8655-6

**Reservoir Rack**

- > For holding up to 7 reservoir rack modules or reagent reservoirs
- > Temperature controlled when used with a thermal module

**Reservoir Rack Module TC**

- > Modules for the reservoir rack
- > 10 modules are available for tube volumes from 0,2 mL to 50 mL
- > 3 Modules for reservoirs 10, 30 and 100 mL
- > Temperature controlled when used with a thermal module

**Rack for single test tubes**

- > For micro test tubes, glass, or plastic tubes of various sizes

**epMotion® thermoracks and adapters**

- > For use with 96-well or 384-well plates and single 0.2 mL tubes
- > Temperature controlled when used with a thermal module

**epMotion® thermoadapters**

- > For heating and cooling of Deepwell Plates
- > Plates can be exchanged by gripper
- > Temperature controlled when used with a thermal module

**Thermorack Rotor/Tubes**

- > Special adapter for temperature controlled pipetting of Qiagen Rotor-Disc® 72/100 and 20 tubes 1.5/2.0 mL
- > Temperature controlled when used with a thermal module

**Thermorack for 24 tubes**

- > Use with 1.5 mL or 2.0 mL Eppendorf Safe-Lock tubes
- > Adapters for 0.5 mL tubes includes
- > Available also for Cryo tubes
- > Temperature controlled when used with a thermal module



## epMotion® Accessories

Ordering information	
Description	Order no.
<b>Rack Smart</b> , for holding one tube rack of SmartCycler™ reaction tubes	5075 790.009
<b>Rack LC 20 µL/100 µL</b> , for up to 96 × 20 µL or 100 µL LightCycler® capillaries for use with Centrifuge 5804/5804 R or 5810/5810 R and other devices, set of 2	5075 795.000
<b>Thermorack CB</b> , for up to 384 × 0.1 mL strip tubes in the Qiagen® Rotor-Gene®	5075 767.031
<b>Thermorack Rotor/Tubes</b> , for temperature controlled pipetting of Qiagen Rotor-Disc® 72/100 and 20 tubes 1.5/2.0 mL	5075 751.526
<b>Thermoadapter for PCR</b> , for temperature control of PCR plates, 96 wells, skirted	5075 787.008
<b>Thermoadapter for PCR</b> , for temperature control of PCR plates, 384 wells, skirted	5075 788.004
<b>Thermoadapter Frosty</b> , combination of height adapter and PCR-Cooler, for cooling skirted PCR plates	5075 789.000
<b>CycleLock Starter Set</b> , 1 frame and 8 mats for automated sealing of Eppendorf PCR plates, can only be used with Mastercycler ep, PCR clean	0030 126.530
<b>CycleLock mats</b> , 5 sealing mats, frame not included, PCR clean	0030 126.548
<b>Adapter sleeves</b> , to retrofit the 1.5/2.0 mL thermoracks for use with 0.5 mL vessels	
1 set of 25 pieces	5075 772.000
<b>Lid for Thermorack Rotor/Tubes</b> , with adapter for placing the lid on the epMotion® worktable	5075 751.640
<b>epMotion® height adapter</b> , for leveling labware, enables faster plate processing, 85 mm	5075 751.003
<b>epMotion® height adapter</b> , for leveling labware, enables faster plate processing, 55 mm	5075 752.000
<b>epMotion® height adapter</b> , for leveling labware, enables faster plate processing, 40 mm, for pipette tips	5075 755.009
<b>Thermoblock DWP 2000</b> , for 2 mL Eppendorf Deepwell Plates 96/2000	5075 751.330
<b>Thermoadapter DWP 96</b> , for Deepwell Plates 96/1000	5075 751.054
<b>Thermoadapter LC Sample</b> , for MagNA Pure LC sample cartridge	5075 751.305
<b>Rack ILMN tubes</b> , Rack for single tubes, 40 × ø 8.4 mm and 12 × ø 11.2 mm, transportable, autoclavable	5075 751.747
<b>Rack for single test tubes</b> , for presenting Eppendorf reaction vessels, glass or plastic tubes, not temperable	
Ø 17 mm × 100 mm max. length	5075 761.009
Ø 17 mm × 60 mm max. length	5075 775.000
Ø 16 mm × 100 mm max. length	5075 760.002
Ø 16 mm × 60 mm max. length	5075 776.006
Ø 15 mm × 100 mm max. length	5075 792.028
Ø 15 mm × 60 mm max. length	5075 792.044
Ø 14 mm × 100 mm max. length	5075 792.001
Ø 14 mm × 60 mm max. length	5075 792.060
Ø 13 mm × 100 mm max. length	5075 762.005
Ø 13 mm × 60 mm max. length	5075 792.087
Ø 12 mm × 100 mm max. length	5075 763.001
Ø 12 mm × 60 mm max. length	5075 792.109
<b>Rack</b> , for 24 HPLC tubes, Ø 12 mm × 40 mm max. length	5075 792.125
<b>Rack</b> , for 96 screw cap tubes, 1.5/2.0 mL	5075 791.005
<b>Rack for 24 tubes</b> , for 24 Safe-Lock tubes, no tempering, 0.5/1.5/2.0 mL	5075 751.453
<b>Rack for 24 tubes</b> , for 24 Safe-Lock tubes, no tempering	
1.5/2.0 mL	5075 751.275
<b>Reservoir rack</b> , for presenting 10 mL, 30 mL and 100 mL reagent reservoirs. Up to 7 reservoirs or Reservoir Rack modules can be presented.	5075 754.002
<b>Extension plate 5075I to TMX and VAC</b> , to be ordered with 5075 000.620 and 5075 000.630 (for units SN>4000)	5075 000.640
<b>Modification kit TMX for 5075I</b> , to modify a 5075I with Eppendorf ThermoMixer® to a 5075t (for units SN>4000)	5075 000.630
<b>Modification kit VAC for 5075I</b> , to modify a 5075I to a 5075v version (for units SN>4000)	5075 000.620
<b>VAC</b> , for retrofitting a 5075 LH version into a VAC version	5075 000.610
<b>TMX</b> , for retrofitting a 5075 LH version into a 5075 TMX version	5075 000.628
<b>epBlue™ ID software and hardware modification kit</b> , for 5070 and 5075 PC versions, barcode support includes software, barcode reader and stand, compatible with all epMotion® PC versions except epMotion® 5075 MC PC version, not compatible with the epMotion® operator panel versions	5075 000.830
<b>TMX expansion board VAC</b> , order with 5075 000.628	5075 000.636
<b>Thermal module</b> , thermal module for heating or cooling (0 – 100 °C) thermoadapters, thermoblock and thermoracks	5075 757.001
<b>TS 10 single channel dispensing tool</b> , 0.2 – 10 µL volume range	5280 000.100
<b>TS 50 single-channel dispensing tool</b> , 1 – 50 µL volume range	5280 000.010
<b>TS 300 single-channel dispensing tool</b> , 20 – 300 µL volume range	5280 000.037
<b>TS 1000 single-channel dispensing tool</b> , 40 – 1,000 µL volume range	5280 000.053
<b>TM 10-8 eight-channel dispensing tool</b> , 0.2 – 10 µL volume range	5280 000.304



Ordering information	
Description	Order no.
<b>TM 50-8 eight-channel dispensing tool</b> , 1 – 50 µL volume range	5280 000.215
<b>TM 300-8 eight-channel dispensing tool</b> , 20 – 300 µL volume range	5280 000.231
<b>TM 1000-8 eight-channel dispensing tool</b> , 40 – 1,000 µL volume range	5280 000.258
<b>Holder for 6 dispensing tools</b>	5075 774.003
<b>Gripper</b> , incl. holder, for transporting plates on the worktable and automatic operation of the vacuum manifold	5282 000.018
<b>Work surface adapter</b> , for raising the epMotion® worktable by 5.5 cm, 4 feet	5070 752.001
<b>Thermoblock for PCR</b> , for temperature control of 96 vessels 0.2 mL, 77 PCR tubes 0.5 mL or one PCR plate 96 wells, semi-skirted	5075 766.000
<b>Thermoblock for PCR</b> , for temperature control of PCR plate 384 wells, semi-skirted	5075 767.007
<b>Thermoblock for Microplate 96/V/U</b> , for holding and temperature control of Eppendorf Microplates with V or U bottom	5075 751.577
<b>Thermorack for 24 tubes</b> , for 24 Safe-Lock tubes, temperable, 0.5/1.5/2.0 mL	5075 769.000
<b>Thermorack for 24 tubes</b> , for 24 Safe-Lock tubes, temperable, 1.5/2.0 mL	5075 771.004
<b>Thermorack TMX</b> , for 24 Safe-Lock micro test tubes, 0.5 mL/1.5 mL/2.0 mL	5075 751.160
<b>Thermorack TMX for 24 tubes</b> , for 24 Safe-Lock tubes, temperable, 0.5/1.5/2.0 mL	5075 751.186
<b>Thermorack</b> , for 24 Cryo tubes	5075 777.055
<b>Holder for Vac Frame</b>	5075 778.009
<b>Vacuum lid</b>	5075 779.005
<b>Mat for vacuum lid</b>	5075 793.008
<b>Vac Frame 1</b> , 16 mm height, recommended for filter plates from 5Prime, Invitex	5075 784.009
<b>Vac Frame 2</b> , 26 mm height, recommended for filter plates from MN, Promega or Qiagen	5075 785.005
<b>Elution plate adapter</b> , for processing micro tubes in racks	5075 785.030
<b>Anticontamination plate adapter</b> , for vacuum processes with foaming solutions in multiwell plates	5075 794.004
<b>Vac Thermo lid</b>	5075 796.007
<b>MultiMediaCard</b> , for archiving parameters and transporting data between the control panel and PC, not for Eppendorf EasyCon™ control panel	5075 780.003
<b>Waste container with ring</b> , for holding used pipette tips	5075 753.006
<b>Panel plate</b> , for control panel rest, mounted at front left side of epMotion® unit	5075 798.000
<b>Collection plate adapter MN</b> , type for VAC station	5075 785.064
<b>Holder for gripper</b>	5075 759.004
<b>PrepRack for 24 Eppendorf Safe-Lock Tubes 2 mL</b> , for nucleic acid preparation with Eppendorf MagSep™ kits	5073 751.006
<b>ReagentRack to hold the reagent tray</b> , from MagSep reagent kits	5075 751.429
<b>Liquid Waste Tub, incl. lid</b> , to mount in the waste box, autoclavable, working volume 115 mL	5075 751.500
<b>Reservoir Rack 3</b> , for max. three 30 mL or 100 mL reservoirs, only for 5075t, 5075m	5075 754.070
<b>epMotion® 96 Accessories</b> , Upgrade set 2-position slider for epMotion® 96	5069 074.008
<b>Reservoir Rack Module TC</b> , for use in epMotion® Reservoir Racks, temperable	
8 × PCR tubes 0.2 mL	5075 799.049
4 × Safe-Lock tubes 0.5/1.5/2.0 mL	5075 799.081
4 × reaction vessels Ø 12 mm	5075 799.103
4 × reaction vessels Ø 16 mm	5075 799.120
4 × reaction vessels Ø 17 mm	5075 799.162
4 × Eppendorf Tubes® 5.0 mL	5075 799.340
2 × reaction vessels Ø 29 mm	5075 799.189
1 × reservoir 10 mL	5075 799.421
1 × reservoir 30 mL	5075 799.146
1 × reservoir 100 mL	5075 799.260
<b>epMotion® reservoir 10 mL</b> , small-volume container for reagent presentation on the epMotion®, can only be inserted with the Reservoir Rack; production batch testing, certified, 10 mL, 10 × 5 reservoirs in the bag, PCR clean, polypropylene	0030 126.521
<b>epMotion® reservoir 30 mL</b> , large-volume container for reagent presentation on the epMotion®, can only be inserted with the Reservoir Rack; production batch testing, certified, 30 mL, 10 × 5 reservoirs in the bag, PCR clean, polypropylene	0030 126.505
<b>epMotion® reservoir 100 mL</b> , large-volume container for reagent presentation on the epMotion®, can only be inserted with the Reservoir Rack; production batch testing, certified, 100 mL, 10 × 5 reservoirs in the bag, PCR clean, polypropylene	0030 126.513
<b>epMotion® reservoir 400 mL</b> , large-volume container for reagent presentation on the epMotion®; production batch testing, certified, 400 mL, 10 reservoirs, autoclavable, polypropylene	5075 751.364

# Sample Handling



Model	Eppendorf ThermoMixer® C	ThermoStat C	Eppendorf ThermoMixer® F0.5
Page(s)	92	94	98
Dimensions (W x D x H)	20.6 x 30.4 x 13.6 cm	20.6 x 30.4 x 13.6 cm	20.6 x 30.4 x 16.3 cm
Weight w/o accessories	6.3 kg	4.3 kg	6.2 kg
Power supply	220 – 240 V, 50 – 60 Hz	220 – 240 V, 50 – 60 Hz	220 – 240 V, 50 – 60 Hz
Max. power consumption	200 W	200 W	200 W
Heating rate	Max. 7 °C/min (when using SmartBlock plates) <sup>1)</sup>	Max. 9 °C/min (when using the SmartBlock PCR 384) <sup>1)</sup>	Max. 15 °C/min
Cooling rate	Max. 2.5 °C/min between 100 °C and RT	Max. 5.0 °C/min between 110 °C and RT <sup>1)</sup>	–
Timer	15 sec to 99:30 h, continuous	15 s to 99:30 h, continuous	–
Mixing and vortexing radius	1.5 mm	–	1.5 mm
Mixing orbit	3 mm	–	3 mm
Mixing frequency	300 – 3,000 rpm <sup>1)</sup>	–	300 – 2,000 rpm
Max. speed	3,000 rpm <sup>1)</sup>	–	2,000 rpm
Temperature settings	1 °C / 100 °C	–10 °C/110 °C (110 °C when using the SmartBlocks 12 mm or cryo)	1 °C / 100 °C
Temperature range	Min: 15 °C (depends on SmartBlock used) below RT, max: 100 °C	Min: 30 °C <sup>1)</sup> below RT, max: 110 °C (110 °C when using the 12 mm and cryo SmartBlocks)	Min: 4 °C above RT, max: 100 °C
Temperature accuracy	Max. ±0.5 °C at 20 – 45 °C	Max. ±0.5 °C at 20 – 45 °C <sup>1)</sup>	Max. ±0.5 °C at 20 – 45 °C
Interfaces	USB interface	USB interface	USB interface
Applications	<ul style="list-style-type: none"> <li>&gt; Plasmid/RNA/DNA purification</li> <li>&gt; cDNA synthesis</li> <li>&gt; Extraction of DNA fragments from agarose gels</li> <li>&gt; Enzymatic reactions (e.g., DNA restriction digestion, Proteinase K digestion and ligation)</li> <li>&gt; Transformation of bacteria strains and plasmids</li> <li>&gt; Denaturation of DNA, RNA, and proteins</li> <li>&gt; Labeling of DNA, RNA, and proteins</li> <li>&gt; Bacterial growth in microreaction vessels, conical tubes, and Deepwell Plates</li> <li>&gt; Lysis reactions at 100 °C</li> <li>&gt; Mixing of PCR setups</li> </ul>	<ul style="list-style-type: none"> <li>&gt; Gentle thawing and cooling buffers and samples at low temperatures</li> <li>&gt; Preheating media</li> <li>&gt; Biochemical reactions at low temperatures</li> <li>&gt; Ligation</li> <li>&gt; cDNA synthesis</li> <li>&gt; Denaturation of RNA, DNA, and protein</li> <li>&gt; Proteinase K digestion</li> <li>&gt; ELISA assays</li> <li>&gt; Immunoprecipitation</li> <li>&gt; Cell lysis</li> </ul>	<ul style="list-style-type: none"> <li>&gt; Growth of bacteria and yeasts</li> <li>&gt; Enzymatic reactions</li> <li>&gt; Transformation of bacteria strains and plasmids</li> <li>&gt; Denaturation of DNA, RNA, and proteins</li> <li>&gt; Lysis reactions at 100 °C</li> <li>&gt; Labeling of nucleic acids and proteins</li> <li>&gt; Proteinase K digestion of cells and tissues</li> <li>&gt; Resuspension of pellets</li> <li>&gt; Mixing protein quantification assays</li> <li>&gt; ELISA assays</li> </ul>

<sup>1)</sup> depends on SmartBlock used

Model	Eppendorf ThermoMixer® F1.5	Eppendorf ThermoMixer® F2.0	Eppendorf ThermoMixer® FP	MixMate®
Page(s)	98	98	98	99
Dimensions (W x D x H)	20.6 x 30.4 x 17.0 cm	20.6 x 30.4 x 17.0 cm	20.6 x 30.4 x 16.4 cm	17 x 23 x 13 cm
Weight w/o accessories	6.3 kg	6.3 kg	6.1 kg	4.2 kg
Power supply	220 – 240 V, 50 – 60 Hz	220 – 240 V, 50 – 60 Hz	220 – 240 V, 50 – 60 Hz	–
Max. power consumption	200 W	200 W	200 W	40 W
Heating rate	Max. 11 °C/min	Max. 13 °C/min	Max. 18 °C/min	–
Cooling rate	–	–	–	–
Timer	–	–	–	–
Mixing and vortexing radius	1.5 mm	1.5 mm	1.5 mm	1.5 mm
Mixing orbit	3 mm	3 mm	3 mm	3 mm
Mixing frequency	300 – 1,500 rpm	300 – 1,500 rpm	300 – 2,000 rpm	300 – 3,000 rpm
Max. speed	1,500 rpm	1,500 rpm	2,000 rpm	3,000 rpm
Temperature settings	1 °C / 100 °C	1 °C / 100 °C	1 °C / 100 °C	–
Temperature range	Min: 4 °C above RT, max: 100 °C	Min: 4 °C above RT, max: 100 °C	Min: 4 °C above RT, max: 100 °C	N/A
Temperature accuracy	Max. ±0.5 °C at 20 – 45 °C	Max. ±0.5 °C at 20 – 45 °C	Max. ±0.5 °C at 20 – 45 °C	–
Interfaces	USB interface	USB interface	USB interface	–
Applications	<ul style="list-style-type: none"> <li>&gt; Growth of bacteria and yeasts</li> <li>&gt; Enzymatic reactions</li> <li>&gt; Transformation of bacteria strains and plasmids</li> <li>&gt; Denaturation of DNA, RNA, and proteins</li> <li>&gt; Lysis reactions at 100 °C</li> <li>&gt; Labeling of nucleic acids and proteins</li> <li>&gt; Proteinase K digestion of cells and tissues</li> <li>&gt; Resuspension of pellets</li> <li>&gt; Mixing protein quantification assays</li> <li>&gt; ELISA assays</li> </ul>	<ul style="list-style-type: none"> <li>&gt; Growth of bacteria and yeasts</li> <li>&gt; Enzymatic reactions</li> <li>&gt; Transformation of bacteria strains and plasmids</li> <li>&gt; Denaturation of DNA, RNA, and proteins</li> <li>&gt; Lysis reactions at 100 °C</li> <li>&gt; Labeling of nucleic acids and proteins</li> <li>&gt; Proteinase K digestion of cells and tissues</li> <li>&gt; Resuspension of pellets</li> <li>&gt; Mixing protein quantification assays</li> <li>&gt; ELISA assays</li> </ul>	<ul style="list-style-type: none"> <li>&gt; Growth of bacteria and yeasts</li> <li>&gt; Enzymatic reactions</li> <li>&gt; Transformation of bacteria strains and plasmids</li> <li>&gt; Denaturation of DNA, RNA, and proteins</li> <li>&gt; Lysis reactions at 100 °C</li> <li>&gt; Labeling of nucleic acids and proteins</li> <li>&gt; Proteinase K digestion of cells and tissues</li> <li>&gt; Resuspension of pellets</li> <li>&gt; Mixing protein quantification assays</li> <li>&gt; ELISA assays</li> </ul>	<ul style="list-style-type: none"> <li>&gt; Resuspending pellets (e.g., bacteria, DNA, cell culture pellets)</li> <li>&gt; Mixing PCR setups</li> <li>&gt; Mixing viscous liquids and suspensions (incl. beads)</li> <li>&gt; Mixing restriction digestions</li> <li>&gt; Immunoassays (e.g., ELISA)</li> <li>&gt; Colorimetric assays (e.g., Bradford, Lowry, BCA)</li> <li>&gt; Reporter gene assays (e.g. β-galactosidase, luciferase)</li> <li>&gt; Vortexing numerous tube formats (e.g., 15 and 50 mL conical tubes)</li> </ul>



On page 366 you will find detailed information on services for these products!

i For more information go to [www.eppendorf.com/temperaturecontrol-mixing](http://www.eppendorf.com/temperaturecontrol-mixing)



Model	Tube 3810X	Safe-Lock Tube 0.5 mL	Safe-Lock Tube 1.5 mL
Page(s)	103	104	104
Volume	1.5 mL	0.5 mL	1.5 mL
Bottom shape	conical	conical	conical
Max. RCF Eppendorf Quality™	30,000 × g	30,000 × g	30,000 × g
Max. RCF PCR clean	30,000 × g	30,000 × g	30,000 × g
Max. RCF Eppendorf Biopur®	-	22,000 × g	22,000 × g
Max. RCF Sterile	-	-	-

<sup>1)</sup> Test conditions: Rotor FA-45-6-30 in Eppendorf Centrifuge 5810 R (using a suitable centrifuge adapter for 15 mL tube), sample: saline solution (density: 1.0 g/mL), controlled centrifugation temp.: 25 °C, centrifugation time: 90 min



Model	Protein LoBind Tubes/ DNA LoBind, 0.5 mL	Protein LoBind Tubes/ DNA LoBind, 1.5 mL	Protein LoBind Tubes/ DNA LoBind, 2.0 mL
Page(s)	117/119	117/119	117/119
Bottom shape	conical	conical	round
Max. RCF PCR clean	18,000 × g/ 30,000 × g	18,000 × g/ 30,000 × g	18,000 × g/ 25,000 × g



Model	Safe-Lock Tube 2.0 mL	Eppendorf Tubes® 5.0 mL with snap cap	Eppendorf Conical Tubes 15 mL	Eppendorf Conical Tubes 50 mL
Page(s)	104	106	108	108
Volume	2.0 mL	5.0 mL	15 mL	50 mL
Bottom shape	round	conical	conical	conical
Max. RCF Eppendorf Quality™	25,000 × g	25,000 × g	-	-
Max. RCF PCR clean	25,000 × g	25,000 × g	-	-
Max. RCF Eppendorf Biopur®	22,000 × g	25,000 × g	-	-
Max. RCF Sterile	-	25,000 × g	19,500 × g <sup>1)</sup>	19,500 × g <sup>1)</sup>



Model	Protein LoBind Tubes/ DNA LoBind, 5.0 mL, conical tubes	Protein LoBind Tubes/ DNA LoBind, 15 mL, conical tubes	Protein LoBind Tubes/ DNA LoBind, 50 mL, conical tubes
Page(s)	117/119	117/119	117/119
Bottom shape	conical	conical	conical
Max. RCF PCR clean	25,000 × g/ 25,000 × g		



**Microplates**

Model	MTP 96/F	MTP 96/U	MTP 96/V
Page(s)	111	111	111
Number of wells	96 wells	96 wells	96 wells
Total volume per well	400 µL	360 µL	350 µL
Working volume	50 – 350 µL	20 – 320 µL	20 – 320 µL
Material	polypropylene	polypropylene	polypropylene
Bottom shape	flat	round	conical
Dimensions (W x D x H)	127.8 x 85.5 x 14.4 mm	127.8 x 85.5 x 14.4 mm	127.8 x 85.5 x 14.4 mm
Max. RCF	6,000 x g	6,000 x g	6,000 x g

<sup>1)</sup> For more Assay/Reader MTPs go to page 112. For Cell Imaging plates go to chapter Cell Imaging Consumables. For twin.tec PCR Plates go to chapter PCR.

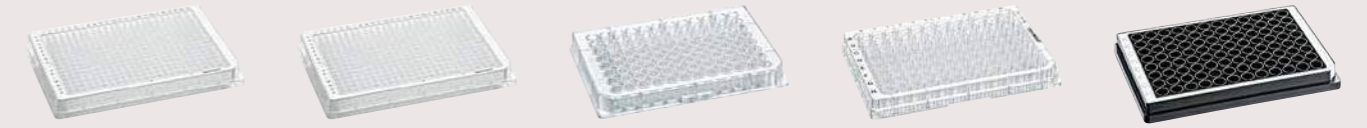

**Microplates**

Model	MTP 384/F	MTP 384/V	MTP UV-VIS 96/F	MTP VIS 96/F	Assay MTP 96/F <sup>1)</sup>
Page(s)	111	111	113	113	113
Number of wells	384 wells	384 wells	96 wells	96 wells	96 wells
Total volume per well	150 µL	140 µL	400 µL	400 µL	400 µL
Working volume	10 – 120 µL	10 – 120 µL	50 – 350 µL	50 – 350 µL	50 – 350 µL
Material	polypropylene	polypropylene	polystyrene/film	polystyrene	polypropylene
Bottom shape	flat	conical	flat	flat	flat
Dimensions (W x D x H)	127.8 x 85.5 x 14.4 mm	127.8 x 85.5 x 14.4 mm	127.8 x 85.5 x 14.4 mm	127.8 x 85.5 x 14.4 mm	127.8 x 85.5 x 14.4 mm
Max. RCF	6,000 x g	6,000 x g	300 x g	3,000 x g	6,000 x g



**Deepwell Plates**

Model	DWP 96/500	DWP 96/1000	DWP 96/2000	DWP 384/200
Page(s)	115	115	115	115
Number of wells	96 wells	96 wells	96 wells	384 wells
Total volume per well	700 µL	1,200 µL	2,400 µL	240 µL
Working volume	30 – 550 µL	30 – 1,000 µL	50 – 2,000 µL	20 – 225 µL
Material	polypropylene	polypropylene	polypropylene	polypropylene
Bottom shape	conical	conical	conical	conical
Dimensions (W x D x H)	127.8 x 85.5 x 27.1 mm	127.8 x 85.5 x 44.1 mm	127.8 x 85.5 x 44.1 mm	127.8 x 85.5 x 25.1 mm
Max. RCF	6,000 x g	6,000 x g	6,000 x g	6,000 x g

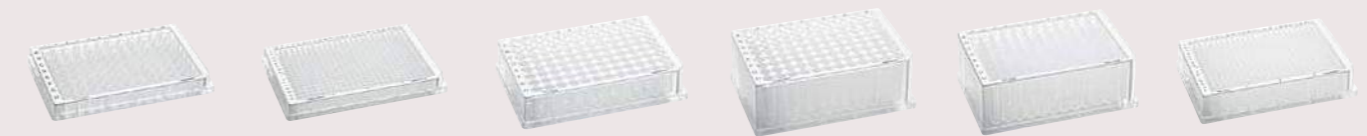

**Protein LoBind Plates/ DNA LoBind Plates**

Model	MTP 96/V	MTP 384/V	DWP 96/500	DWP 96/1000	DWP 96/2000	DWP 384/200
Page(s)	116/118	116/118	116/118	116/118	116/118	116/118
Number of wells	96 wells	384 wells	96 wells	96 wells	96 wells	384 wells
Total volume per well	350 µL	140 µL	700 µL	1,200 µL	2,400 µL	240 µL
Working volume	20 – 300 µL	5 – 120 µL	30 – 550 µL	30 – 1,000 µL	50 – 2,000 µL	20 – 225 µL
Material	polypropylene	polypropylene	polypropylene	polypropylene	polypropylene	polypropylene
Bottom shape	conical	conical	conical	conical	conical	conical
Dimensions (W x D x H)	127.8 x 85.5 x 14.4 mm	127.8 x 85.5 x 14.4 mm	127.8 x 85.5 x 27.1 mm	127.8 x 85.5 x 44.1 mm	127.8 x 85.5 x 44.1 mm	127.8 x 85.5 x 25.1 mm
Max. RCF	6,000 x g	6,000 x g	6,000 x g	6,000 x g	6,000 x g	6,000 x g

# Eppendorf ThermoMixer® C

## Description

You need everything? The Eppendorf ThermoMixer C combines excellent mixing performance with excellent temperature control to guarantee complete, dependable and reproducible test results. Improve your assay results by mixing and incubating samples at the same time. The Eppendorf ThermoMixer C convinces users with its quick and easy-to-exchange SmartBlocks for all common lab vessels, new and improved program functions, and high level of stability for every mixing frequency. There is almost no limit to the variety of applications waiting for you!



	Plate type	96-well plates	384-well plates
<b>Mixing of different buffers</b>			
Buffer with detergent	PCR	30 s 1,800 rpm	30 s 2,800 rpm
Buffer without detergent	PCR	1 min 2,000 rpm	30 s 3,000 rpm
Buffer with high salt concentration	DWP	5 s 1,400 rpm	30 s 2,000 rpm
Buffer with DMSO	MTP	5 s 1,100 rpm	5 s 2,000 rpm
<b>Mixing of viscous solutions</b>			
Genomic-DNA	PCR	30 s 2,000 rpm	1 min 3,000 rpm
<b>Resuspension of pellets</b>			
Bacteria cell pellets	DWP	30 s 2,000 rpm	2 min 2,000 rpm

Eppendorf ThermoMixer C provides enough mixing power to handle also challenging mixing tasks. Most samples are efficiently mixed within less than a minute independent of vessel geometry or sample properties. For more informations see AppNote 130.

## Product features

- > Mixing, heating, and cooling in one instrument for high flexibility
- > All common vessels and plate formats from 5 µL to 50 mL by different Eppendorf SmartBlocks for standard applications
- > Excellent <sup>2D</sup>Mix-Control technology results in excellent sample mixing
- > Anti-spill technology prevents lid wetting and cross-contamination
- > Increased mixing frequency of up to 3,000 rpm for effective sample mixing
- > Excellent temperature management for maximum temperature accuracy, resulting in safe handling
- > Compatible with Eppendorf ThermoTop (**condens.protect**®) for condensation-free sample handling (for Eppendorf SmartBlocks up to 2.0 mL)
- > Predefined program keys and clearly arranged menu guides enable simple and intuitive operations
- > Freely programmable program keys for individual optimization
- > Eppendorf PhysioCare Concept® provides ergonomic design and operation



[www.eppendorf.com/thermomixer-c-brochure](http://www.eppendorf.com/thermomixer-c-brochure)



[www.eppendorf.com/thermomixer-c-video](http://www.eppendorf.com/thermomixer-c-video)

## 50 µL sample mixing with 1,800 rpm

Competitor 1 min



Suboptimal sample mixing

Eppendorf <sup>2D</sup>Mix-Control 1 min (MixMate®)



Reliable sample mixing

Eppendorf <sup>2D</sup>Mix-Control 1 min (Eppendorf ThermoMixer®)



Reliable sample mixing

# Transfer Racks Eppendorf SmartBlock™

## Description

Performing a 60-sec-incubation step for 24 samples in parallel? The Eppendorf Transfer Rack enables a safe and easy transfer of up to 24 samples in parallel to or from the Eppendorf SmartBlock. This provides similar reaction conditions for all samples of your experiment. The Transfer Rack is available for the SmartBlock 0.5 mL as well as the SmartBlock 1.5 and 2.0 mL. These SmartBlocks include a Transfer Rack by standard.



## Product features

- > Holds up to 24 microtubes (i.e. 0.5 mL, 1.5 mL, or 2.0 mL) for easy transfer of multiple vessels in parallel
- > Convenient transfer of up to 24 hot vessels without burning the fingers
- > Temperature range from -96 °C to 121 °C for broad flexibility
- > Optimized block design guarantees maximum temperature transfer to the sample
- > Eppendorf QuickRelease™ technology enables fast and simple block exchange – no need for tools

## Ordering information

Description	Order no.
Eppendorf ThermoMixer® C, basic device without thermoblock, 220 – 240 V/50 – 60 Hz	5382 000.015
Transfer Rack 0.5 mL, for Eppendorf SmartBlock™ 0.5 mL	3880 000.305
Transfer Rack 1.5/2.0 mL, for Eppendorf SmartBlock™ 1.5 mL and Eppendorf SmartBlock™ 2.0 mL	3880 000.151
Lid, for Eppendorf ThermoMixer® F0.5/F1.5/F2.0 and FP, for Eppendorf SmartBlock™ 0.5 – 2.0 mL, plates, PCR 96, PCR 384, and DWP	5363 000.233
Eppendorf ThermoTop®, with <b>condens.protect</b> ® technology	5308 000.003
Eppendorf SmartBlock™ 0.5 mL, thermoblock for 24 reaction vessels 0.5 mL, incl. Transfer Rack 0.5 mL	5361 000.031
Eppendorf SmartBlock™ 1.5 mL, thermoblock for 24 reaction vessels 1.5 mL, incl. Transfer Rack 1.5/2.0 mL	5360 000.038
Eppendorf SmartBlock™ 2.0 mL, thermoblock for 24 reaction vessels 2.0 mL, incl. Transfer Rack 1.5/2.0 mL	5362 000.035
Eppendorf SmartBlock™ 5 mL, thermoblock for 8 Eppendorf Tubes® 5.0 mL, 8 × 5.0 mL reaction vessels	5309 000.007
Eppendorf SmartBlock™ 15 mL, thermoblock for 8 conical tubes 15 mL	5366 000.021
Eppendorf SmartBlock™ 50 mL, thermoblock for 4 conical tubes 50 mL	5365 000.028
Eppendorf SmartBlock™ 12 mm, thermoblock for 24 reaction vessels, diameter up to 12 mm, height 35 mm – 76 mm	5364 000.024
Eppendorf SmartBlock™ PCR 96, thermoblock for PCR plates 96, incl. lid	5306 000.006
Eppendorf SmartBlock™ PCR 384, thermoblock for PCR plates 384, incl. lid	5307 000.000
Eppendorf SmartBlock™ DWP 500, thermoblock for Eppendorf Deepwell Plates 96/500 µL, incl. lid	5316 000.004
Eppendorf SmartBlock™ DWP 1,000, thermoblock for Eppendorf Deepwell Plate 96/1000 µL, incl. lid	5310 000.002
Eppendorf SmartBlock™ cryo, thermoblock for 24 cryo tubes, 1.5 mL – 2 mL, max. external diameter 12.5 mm, all base designs	5367 000.025
Eppendorf SmartBlock™ plates, thermoblock for microplates and Deepwell Plates, incl. lid	5363 000.039

✎ Ordering information for other voltage options begins on page 434

# Eppendorf ThermoStat™ C

## Description

Many experiments require fast heating and cooling steps in a very accurate manner. Precise temperature control is achieved for the ThermoStat C by using optimally balanced heating and cooling elements (peltier technology).



## Product features

- > Heating and active cooling in all common vessel and plate formats from 5 µL to 50 mL for high flexibility
- > Broad range of SmartBlocks enables high vessel flexibility
- > Excellent temperature accuracy for safe sample handling
- > Very fast cooling rates of up to 5 °C/min, reducing your waiting time
- > Low temperature (e.g. 4 °C or 0 °C) even at higher ambient temperatures for safe sample incubation
- > Temperature keys (4 °C, 16 °C, 37 °C, 56 °C, and 95 °C) provide quick access to commonly used experimental temperatures
- > Eppendorf ThermoTop (**condens.protect**®) compatibility prevents condensation and improves temperature homogeneity within sample tubes (up to 2.0 mL)
- > Comprehensive range of program slots (up to 15) for flexible usage of device

## Ordering information

Description	Order no.
Eppendorf ThermoStat™ C, basic device without thermoblock, 220 – 240 V/50 – 60 Hz	5383 000.019
Eppendorf ThermoTop®, with <b>condens.protect</b> ® technology	5308 000.003

✎ Ordering information for other voltage options begins on page 434

ï For more information go to [www.eppendorf.com/thermostat-c](http://www.eppendorf.com/thermostat-c)

# Eppendorf SmartBlock™

## Description

Using different vessel sizes within your lab workflow? Flexibility has never been this easy. Eppendorf offers a broad range of SmartBlocks for tubes from 0.2 mL to 50 mL as well as plates (MTP, DWP, and PCR plates 96 / 384) to use with Eppendorf ThermoMixer® C and ThermoStat C. All SmartBlocks are equipped with the outstanding Eppendorf QuickRelease system that makes the block exchange super fast and easy. Just press the lever on the front of the block and the block can be removed – no tools are needed, done in seconds.



## Product features

- > Optimized block design supports optimal temperature transfer within your sample to receive excellent results
- > Eppendorf SmartBlock-specific calibration by integrated sensor technology maximizes temperature accuracy and homogeneity
- > Every SmartBlock is individually inspected in production for temperature accuracy and is delivered incl. a serial-number specific certificate for documentation purpose
- > Insulated thermoblocks for ergonomic operation – you won't burn your fingers (PhysioCare Concept)
- > Automatic block recognition for safe handling
- > Optimized block design guarantees maximum temperature transfer to the sample
- > Eppendorf QuickRelease™ technology enables fast and simple block exchange – no need for tools

## Eppendorf SmartBlocks for the following reaction vessels:

- A. 24 lab vessels up to 12 mm in diameter
- B. 8 × 15 mL conical tubes
- C. 4 × 50 mL conical tubes
- D. Eppendorf Deepwell Plates 96/500 µL
- E. Eppendorf Deepwell Plates 96/1000 µL
- F. 24 × cryo tubes
- G. 8 × Eppendorf Tubes® 5.0 mL
- H. Lid for Eppendorf SmartBlock plates, PCR 96, PCR 384, DWP, 0.5 mL, 1.5 mL and 2.0 mL
- I. 384-well PCR plates
- J. 96-well PCR plates
- K. 24 × 0.5 mL vessels
- L. 24 × 1.5 mL vessels
- M. 24 × 2.0 mL vessels
- N. MTPs and Deepwell Plates



[www.eppendorf.com/smartblock-video](http://www.eppendorf.com/smartblock-video)

ï For more information go to [www.eppendorf.com/smartblocks](http://www.eppendorf.com/smartblocks)



## Eppendorf SmartBlock™



Technical specifications					
Description	Lid <sup>1)</sup>	Max. speed <sup>2)</sup>	Max. temp.	ThermoMixer C ThermoStat C	ThermoTop
Eppendorf SmartBlock™ 0.5 mL	■	2,000 rpm	100 °C	■	■
Eppendorf SmartBlock™ 1.5 mL	■	2,000 rpm	100 °C	■	■
Eppendorf SmartBlock™ 2.0 mL	■	2,000 rpm	100 °C	■	■
Eppendorf SmartBlock™ 5 mL	■	1,000 rpm	100 °C	■	■
Eppendorf SmartBlock™ 15 mL	■	1,000 rpm	100 °C	■	■
Eppendorf SmartBlock™ 50 mL	■	1,000 rpm	100 °C	■	■
Eppendorf SmartBlock™ 12 mm	■	2,000 rpm	110 °C <sup>4)</sup>	■	■
Eppendorf SmartBlock™ cryo	■	2,000 rpm	110 °C <sup>4)</sup>	■	■
Eppendorf SmartBlock™ plates	■	3,000 rpm <sup>3)</sup>	100 °C	■	■
Eppendorf SmartBlock™ PCR 96	■	2,000 rpm	100 °C	■	■
Eppendorf SmartBlock™ PCR 384	■	3,000 rpm	100 °C	■	■
Eppendorf SmartBlock™ DWP 500	■	1,500 rpm	100 °C	■	■
Eppendorf SmartBlock™ DWP 1,000	■	1,500 rpm	100 °C	■	■

<sup>1)</sup> Maximum mixing frequency is 2,000 rpm when lid is used <sup>2)</sup> Max. speed depends on exact fitting of vessel <sup>3)</sup> max. mixing frequency using DWP is 2,000 rpm (80°C and higher: limited to 1,000 rpm) <sup>4)</sup> Only available with ThermoStat C

## Ordering information

Description	Order no.
Transfer Rack 1.5/2.0 mL, for Eppendorf SmartBlock™ 1.5 mL and Eppendorf SmartBlock™ 2.0 mL	3880 000.151
Transfer Rack 0.5 mL, for Eppendorf SmartBlock™ 0.5 mL	3880 000.305
Lid, for Eppendorf ThermoMixer® F0.5/F1.5/F2.0 and FP, for Eppendorf SmartBlock™ 0.5 – 2.0 mL, plates, PCR 96, PCR 384, and DWP	5363 000.233
Eppendorf SmartBlock™ 0.5 mL, thermoblock for 24 reaction vessels 0.5 mL, incl. Transfer Rack 0.5 mL	5361 000.031
Eppendorf SmartBlock™ 1.5 mL, thermoblock for 24 reaction vessels 1.5 mL, incl. Transfer Rack 1.5/2.0 mL	5360 000.038
Eppendorf SmartBlock™ 2.0 mL, thermoblock for 24 reaction vessels 2.0 mL, incl. Transfer Rack 1.5/2.0 mL	5362 000.035
Eppendorf SmartBlock™ 5 mL, thermoblock for 8 Eppendorf Tubes® 5.0 mL, 8 x 5.0 mL reaction vessels	5309 000.007
Eppendorf SmartBlock™ 15 mL, thermoblock for 8 conical tubes 15 mL	5366 000.021
Eppendorf SmartBlock™ 50 mL, thermoblock for 4 conical tubes 50 mL	5365 000.028
Eppendorf SmartBlock™ 12 mm, thermoblock for 24 reaction vessels, diameter up to 12 mm, height 35 mm – 76 mm	5364 000.024
Eppendorf SmartBlock™ PCR 96, thermoblock for PCR plates 96, incl. lid	5306 000.006
Eppendorf SmartBlock™ PCR 384, thermoblock for PCR plates 384, incl. lid	5307 000.000
Eppendorf SmartBlock™ DWP 500, thermoblock for Eppendorf Deepwell Plates 96/500 µL, incl. lid	5316 000.004
Eppendorf SmartBlock™ DWP 1,000, thermoblock for Eppendorf Deepwell Plate 96/1000 µL, incl. lid	5310 000.002
Eppendorf SmartBlock™ cryo, thermoblock for 24 cryo tubes, 1.5 mL – 2 mL, max. external diameter 12.5 mm, all base designs	5367 000.025
Eppendorf SmartBlock™ plates, thermoblock for microplates and Deepwell Plates, incl. lid	5363 000.039

## Eppendorf ThermoTop®

## Description

Tired of condensation in your tubes? We combined the Eppendorf ThermoMixer® with the PCR cycler approach of a heated lid and generated the Eppendorf ThermoTop. The outstanding Eppendorf **condens.protect** technology reliably prevents condensation within the tube lid – sample concentrations are consistent for the incubation time. In addition, the temperature homogeneity is further improved. Get optimal sample reaction conditions to produce optimal results.



## Applications

> All temperature control procedures for which the formation of condensation on the tube lid and wall should be reliably avoided



## Product features

- > Efficient and reliable of condensation prevention for safe sample heating
- > Get constant reaction conditions for optimal enzymatic performance within your samples
- > Wireless connection with automatic recognition and operation for user-friendly handling
- > Suitable for use with Eppendorf ThermoMixer F0.5/F1.5/F2.0/FP as well as Eppendorf ThermoMixer C and ThermoStat C with Eppendorf SmartBlocks 0.5 mL, 1.5 mL, 2.0 mL, plates, PCR 96, and PCR 384 (not in combination with Eppendorf Transfer Rack)

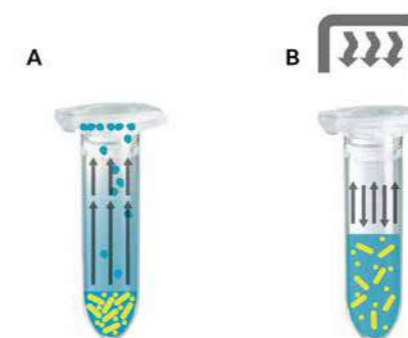

## Principle:

- A = Condensation without ThermoTop  
B = Free of contamination with ThermoTop



[www.eppendorf.com/thermotop-video](http://www.eppendorf.com/thermotop-video)

## Ordering information

Description	Order no.
Eppendorf ThermoTop®, with <b>condens.protect</b> ® technology	5308 000.003

i For more information go to [www.eppendorf.com/thermotop](http://www.eppendorf.com/thermotop)

# Eppendorf ThermoMixer® F

## Description

Doing quite routine sample prep steps? Whether you regularly work with 0.5/1.5/2.0 mL vessels or plates (MTP and DWP) – our customized fixed-block Eppendorf ThermoMixer F family offers you the perfect solution for your special application. Just simplify your routine work load.



## Product features

- > Heating and mixing in 0.5/1.5/2.0 mL reaction vessels (F0.5/F1.5/F2.0) or plates (FP)
- > Up to 1,500 rpm (F1.5/F2.0) or 2,000 rpm (F0.5/FP) for efficient sample mixing
- > Outstanding <sup>2D</sup>Mix-Control technology results in excellent mixing performance
- > Anti-spill technology prevents lid wetting and cross-contamination
- > Compatible with Eppendorf ThermoTop (**condens.protect**®) for condensation-free sample handling
- > Predefined temperature keys (37 °C, 42 °C, 56 °C, and 95 °C) for simple and intuitive operation
- > Very fast heat up speed of up to 18 °C/min, reducing your waiting time
- > Eppendorf PhysioCare Concept provides ergonomic design and operation

## Ordering information

Description	Order no.
Eppendorf ThermoMixer® FP, with thermoblock for Microplates and Deepwell Plates, including lid, 220 – 240 V/50 – 60 Hz	5385 000.016
Eppendorf ThermoMixer® F0.5, with thermoblock for 24 reaction vessels 0.5 mL, 220 – 240 V/50 – 60 Hz	5386 000.010
Eppendorf ThermoMixer® F1.5, with thermoblock for 24 reaction vessels 1.5 mL, 220 – 240 V/50 – 60 Hz	5384 000.012
Eppendorf ThermoMixer® F2.0, with thermoblock for 24 reaction vessels 2.0 mL, 220 – 240 V/50 – 60 Hz	5387 000.013
Eppendorf ThermoTop®, with <b>condens.protect</b> ® technology	5308 000.003

✂ Ordering information for other voltage options begins on page 434



[www.eppendorf.com/thermomixer-f-video](http://www.eppendorf.com/thermomixer-f-video)

# MixMate®

## Description

Straight mixing required? Mix your samples in seconds, fully and reliably. Whether in plates (96 or 384-wells) or reaction tubes, your samples will be optimally processed. With the integrated ergonomic vortex function, the MixMate is your perfect lab assistant. The innovative additional 2 second run timer allows vortexing your next sample without restarting.



	Plate type	96-well plates	384-well plates
<b>Mixing of different buffers</b>			
Buffer with detergent	PCR	15 s 1,800 rpm	45 s 2,800 rpm
Buffer without detergent	PCR	30 s 2,100 rpm	30 s 3,000 rpm
Buffer with high salt concentration	DWP	5 s 1,400 rpm	1 min 2,000 rpm
Buffer with DMSO	MTP	5 s 1,100 rpm	5 s 2,200 rpm
<b>Mixing of viscous solutions</b>			
Genomic-DNA	PCR	30 s 2,000 rpm	45 s 3,000 rpm
<b>Resuspension of pellets</b>			
Bacteria cell pellets	DWP	30 s 2,000 rpm	3 min 2,000 rpm

MixMate provides enough mixing power to handle the most challenging mixing tasks. Most samples are efficiently mixed within less than a minute independent of vessel geometry or sample properties. For more information see AppNote 130.

## Product features

- > High-speed mixer (3,000 rpm) for fast and efficient mixing of small volumes in all common vessel formats up to 2 mL
- > <sup>2D</sup>Mix-Control technology (planar mixing orbit without vertical movement) for controlled mixing and reproducible results in seconds
- > Anti-spill technology for controlled mixing movements without lid wetting and cross-contamination
- > 3 different tube holders (0.5 mL, 1.5/2.0 mL, PCR 96 plates) for high vessel flexibility
- > Integrated ergonomic vortex function for various vessel formats for distinct sample mixing
- > Minimal hand/arm vibration transfer during vortexing (certificate available) for ergonomic operation (PhysioCare Concept®)
- > 5 soft keys with pre-defined standard mixing parameters for easy usage
- > Very stable - remains stationary even at maximum mixing speed
- > Whisper quiet operation to benefit the work environment



## Ordering information

Description	Order no.
MixMate®, incl. 3 tube holders: PCR 96, 0.5 mL, 1.5/2.0 mL, 230 V/50 – 60 Hz	5353 000.014
Tube Holder 0.5 mL, for 24 × 0.5 mL reaction vessels	5353 040.121
Tube Holder 1.5/2.0 mL, for 24 × 1.5 mL or 2.0 mL reaction vessels	5353 040.130
Tube Holder PCR 96, for 96 × 0.2 mL PCR tubes, PCR strips or 1 × 96-well PCR plate, semi-skirted or unskirted	5353 040.113

✂ Ordering information for other voltage options begins on page 434

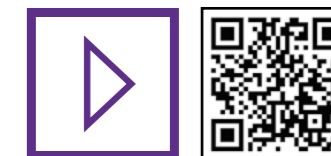

[www.eppendorf.com/mixmate-video](http://www.eppendorf.com/mixmate-video)

# Accessories



## IsoTherm-System®

- > IsoTherm-System: IsoRack (work rack), IsoSafe (insulating box), and two IsoPacks (cool packs)
- > Ideal for cooling, transporting, and storing deep-frozen samples
- > Dry incubation technology reduces contamination risk associated with classical icebath incubation for safe sample handling
- > Holds up to 24 micro tubes (e.g., 0.5 mL or 1.5 mL/2.0 mL) for broad flexibility
- > Two versions of IsoPack (cold pack) available: White maintains 0 °C for up to 6 hours. Blue maintains -21 °C for up to 3 hour
- > Racks are stackable, autoclavable and can be centrifuged in the MTP rotor



## PCR-Cooler

- > Handling system for sample set-up, protection, transport, and storage of sensitive samples – keep you samples safe
- > Clear temperature indicator: Color of PCR cooler changes when temperature exceeds 7 °C
- > Accommodates PCR-vessels as tubes, strips, or plates for flexible vessel usage
- > Dry incubation technology reduces contamination risk of samples
- > Keeps an entire 96-well PCR plate cold for more than an hour at 0 °C (with two-hour precooling at -20 °C) for safe samples

### Color change

Eppendorf PCR-cooler changes color depending on temperature (up to 1 h at 0 °C after precooling at -20 °C)

below 7 °C

above 7 °C



### Ordering information

Description	Order no.
<b>IsoTherm-System® starter set</b> , includes IsoSafe, IsoRack, 0 °C IsoPack and -21 °C IsoPack	
for 0.5 mL tubes	3880 000.011
for 1.5/2.0 mL tubes	3880 001.018
<b>IsoPack and IsoRack set</b> , includes one IsoPack and one IsoRack	
for 0.5 mL vessels, 0 °C	3880 000.160
for 0.5 mL vessels, -21 °C	3880 000.178
for 1.5/2.0 mL vessels, 0 °C	3880 001.166
for 1.5/2.0 mL vessels, -21 °C	3880 001.174
<b>IsoSafe and IsoPack</b> , includes 1 IsoSafe and 3 IsoPack	
for 1.5/2.0 mL vessels, 0 °C	3880 001.026
for 1.5/2.0 mL vessels, -21 °C	3880 001.042

### Ordering information

Description	Order no.
<b>PCR-Cooler 0.2 mL Starter Set</b> , (1 x pink, 1 x blue)	3881 000.015
PCR-Cooler 0.2 mL, Pink	3881 000.023
PCR-Cooler 0.2 mL, Blue	3881 000.031

# Eppendorf Purity Grades for Tubes and Plates



## Eppendorf sample handling consumables stand for highest quality and purity

Our tubes and plates are available in a variety of purity grades (see table below) [www.eppendorf.com/purity](http://www.eppendorf.com/purity). The purity grades "sterile", "PCR clean", "Biopur®" and "Forensic DNA Grade" are certified by an accredited external lab. As a special service, we make the lot-specific certificates available online ([www.eppendorf.com/certificates](http://www.eppendorf.com/certificates))

Purity grades	Eppendorf Quality™	Eppendorf sterile	Eppendorf PCR clean	Eppendorf Forensic DNA Grade <sup>5)</sup>	Eppendorf Biopur®
<b>Eppendorf purity grades for tubes and plates</b>					
<b>Continuous quality control for the following relevant criteria:</b>					
Function, tightness, precision	■	■	■	■	■
Low wetting	■	■	■	■	■
High chemical resistance	■	■	■	■	■
High thermal resistance	■	■	■	■	■
High resistance to centrifugation forces <sup>1)</sup>	■	■	■	■	■
High transparency	■	■	■	■	■
Precisely shaped	■	■	■	■	■
<b>Lot-specific certificates<sup>2)</sup> for the following purity criteria:</b>					
Pyrogen-free (endotoxin-free)		■			■
Sterile (Ph.Eur./USP)		■			■
Human DNA-free			■	■	■
DNA-free (Human- and bacteria DNA)					■
DNase-free			■	■	■
RNase-free			■	■	■
PCR-inhibitor-free			■	■	■
ATP-free					■
<b>Eppendorf Tubes®</b>					
Safe-Lock Tubes	■		■	■	■ <sup>3)</sup>
3810X	■		■		
Eppendorf Tubes® 5.0 mL	■	■	■	■	■ <sup>3)</sup>
Conical Tubes 15 mL and 50 mL		■ <sup>4)</sup>		■ <sup>3)</sup>	
DNA and Protein LoBind Tubes			■		
PCR Tubes (PCR and real-time PCR)			■	■	
Cap Strips (PCR and real-time PCR)			■	■	
<b>Eppendorf Plates® and accessories</b>					
Deepwell Plates and Microplates		■	■		
Protein LoBind Deepwell Plates			■		
DNA LoBind Deepwell Plates			■		
Eppendorf twin.tec® PCR Plates (PCR and real-time PCR)			■		■
Eppendorf twin.tec® PCR Plates				■ <sup>3)</sup>	■
Heat Sealing Film and Foil			■		
PCR Storage Films and Foils			■		
Plate Lid		■	■		

<sup>1)</sup> For accurate details regarding resistance to centrifugation, please refer to the respective product pages. <sup>2)</sup> Lot-specific certificate can be downloaded from [www.eppendorf.com/certificates](http://www.eppendorf.com/certificates). <sup>3)</sup> Individually packaged. <sup>4)</sup> Eppendorf sterile, RNase free, DNase free, DNA free (human and bacteria DNA) <sup>5)</sup> According to ISO 18385.

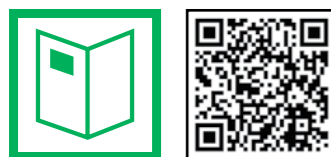

[www.eppendorf.com/puritygrades-brochure](http://www.eppendorf.com/puritygrades-brochure)

Technical specifications subject to change.

# Eppendorf Tubes® 3810X

## Description

The easy-to-open, securely closing, Eppendorf Tubes® 3810X offers comfort and dependability for sample preparation, centrifugation, and storage. One vessel for all applications in molecular biology, chemistry, and biochemistry.

**Safer than ever: Eppendorf Tubes® 3810X** can be centrifuged up to 30,000 × g without any problems!



The 3810X tube guarantees tried and tested tight lid closure and easy, stress-free opening and closing.

## Product features

- > Tube lid is easy to open and close for ergonomic operation
- > Polypropylene provides high resistance to chemicals, mechanical stress, and temperature extremes
- > g-Safe®: Exceptional centrifugation stability up to 30,000 × g prevents sample loss due to tube breakage and provides extra safety when working with hazardous samples
- > Manufactured without the use of slip agents, plasticizers, and biocides – substances that have been shown to leach from plastic consumables into the sample and negatively affect bio-assay results
- > Graduation for simple verification of the pipetted volume
- > Frosted lid and surface on the side for easy labeling
- > Guaranteed functionality from -86 °C to 100 °C
- > Autoclavable when open (121 °C, 20 min)
- > Available in Eppendorf Quality and lot-certified PCR clean purity grade

## Ordering information

Description	Color	Order no.
<b>Eppendorf Tubes® 3810X, 1.5 mL, g-safe® centrifugation stability</b>		
Eppendorf Quality™, 1,000 pcs.	□ colorless	0030 125.150
Eppendorf Quality™, 1,000 pcs.	■ blue	0030 125.177
Eppendorf Quality™, 1,000 pcs.	■ yellow	0030 125.207
Eppendorf Quality™, 1,000 pcs.	■ green	0030 125.185
Eppendorf Quality™, 1,000 pcs.	■ red	0030 125.193
PCR clean, 1,000 pcs.	□ colorless	0030 125.215
<b>Eppendorf Tube Rack, 36 positions, for 1.5 mL and 2.0 mL tubes, 2 pcs., polypropylene, numbered positions, autoclavable</b>		
		0030 119.819
<b>Storage Box 8 × 8, for 64 tubes 1 – 2 mL, 3 pcs., height 53 mm, 2 inch, polypropylene, for freezing to -86 °C, autoclavable, with lid and alphanumeric code</b>		
		0030 140.524

For more information go to [www.eppendorf.com/consumables](http://www.eppendorf.com/consumables)

Your local distributor: [www.eppendorf.com/contact](http://www.eppendorf.com/contact)  
Eppendorf AG · Barkhausenweg 1 · 22339 Hamburg · Germany · [eppendorf@eppendorf.com](mailto:eppendorf@eppendorf.com) · [www.eppendorf.com](http://www.eppendorf.com)

# Eppendorf Safe-Lock Tubes

## Description

Eppendorf Safe-Lock Tubes are the result of 50 years of continuous improvement and development. The original Safe-Lock tubes protect your sample with excellent centrifugation stability, feature perfect sealing properties, and reliably prevent sample evaporation. Trust in the original Eppendorf Safe-Lock Tubes, because your samples deserve nothing but the best.

**Safer than ever!** Tests at 30,000 × g have shown that vessels can break during centrifugation. Eppendorf Safe-Lock Tubes are guaranteed to withstand forces up to 30,000 × g, allowing you to safely centrifuge without sample loss.



## Product features

- > Hinged Eppendorf Safe-Lock lid prevents unintentional lid opening during incubation and storage
- > Polypropylene provides high resistance to chemicals, mechanical stress and temperature extremes
- > Manufactured without the use of slip agents, plasticizers, and biocides – substances that have been shown to leach from plastic consumables into the sample and negatively affect bio-assay results
- > g-Safe®: Exceptional centrifugation stability up to 30,000 × g prevents sample loss due to tube breakage and provides extra safety when working with hazardous samples
- > Precise lid sealing for minimal evaporation rates during long-term storage
- > Large frosted lid and surface on the side for easy labeling
- > Guaranteed functionality from -86 °C to 100 °C
- > Autoclavable when open (121 °C, 20 min)
- > Available in lot-certified PCR clean, Eppendorf Forensic DNA Grade, and Biopur quality for guaranteed purity
- > Available in Eppendorf Protein and DNA LoBind material for maximum recovery of valuable samples

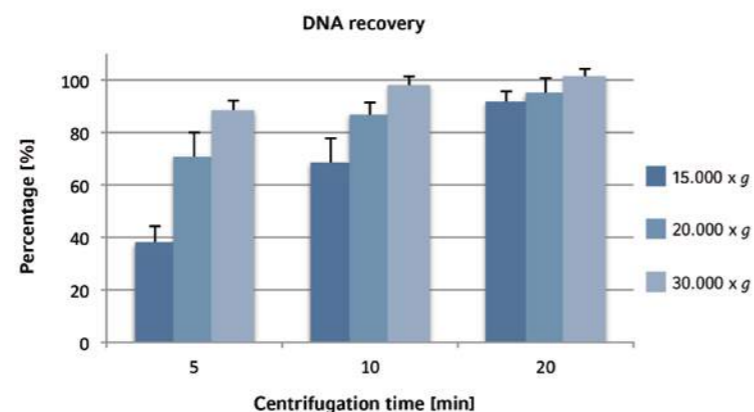

Using the Eppendorf 30,000 × g system comprising of Safe-Lock Tubes and Centrifuge 5430 R with high-speed rotor, the effect of relative centrifugal force (rcf), duration of centrifugation and the amount of isopropanol on the recovery rate of plasmid DNA from alcohol precipitation were investigated. All three factors play a role, with rcf having the greatest effect. By centrifuging the Eppendorf Safe-Lock Tubes at 30,000 × g, nearly 90 % of DNA could be recovered from a 5 min centrifugation. For more information see Application Note 234.

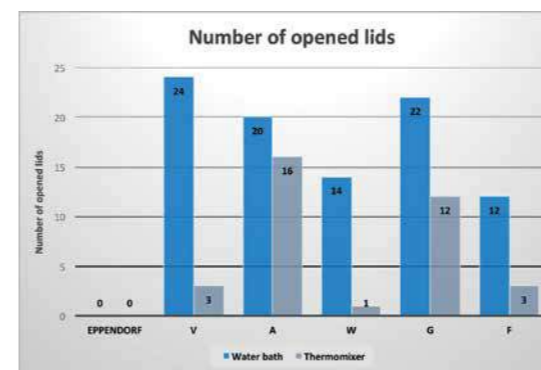

Test conditions: 24 tubes of different manufacturers were incubated either in water bath or thermo mixer with nominal volume (1.5 mL) of 1 % SDS at 100 °C for 10 min.

## Ordering information

Description	Order no.
<b>Eppendorf Safe-Lock Tubes, 0.5 mL</b>	
Eppendorf Quality™, 500 tubes	□ colorless 0030 121.023
Eppendorf Quality™, 500 tubes	■ yellow 0030 121.112
Eppendorf Quality™, 500 tubes	■ red 0030 121.120
Eppendorf Quality™, 500 tubes	■ blue 0030 121.139
Eppendorf Quality™, 500 tubes	■ green 0030 121.147
Eppendorf Quality™, 500 tubes	■ amber (light protection) 0030 121.155
Eppendorf Quality™, 500 tubes	assorted colors (per 100) 0030 121.708
Forensic DNA Grade, 500 tubes (10 bags × 50 tubes)	□ colorless 0030 123.603
PCR clean, 500 tubes	□ colorless 0030 123.301
Eppendorf Biopur®, 50 tubes, individually packed	□ colorless 0030 121.570
<b>Eppendorf Safe-Lock Tubes, 1.5 mL</b>	
Eppendorf Quality™, 1,000 tubes	□ colorless 0030 120.086
Eppendorf Quality™, 1,000 tubes	■ yellow 0030 120.159
Eppendorf Quality™, 1,000 tubes	■ red 0030 120.167
Eppendorf Quality™, 1,000 tubes	■ blue 0030 120.175
Eppendorf Quality™, 1,000 tubes	■ green 0030 120.183
Eppendorf Quality™, 1,000 tubes	■ amber (light protection) 0030 120.191
Eppendorf Quality™, 1,000 tubes	assorted colors (per 200) 0030 121.694
Eppendorf Biopur®, 100 tubes, individually packed	□ colorless 0030 121.589
Forensic DNA Grade, 500 tubes (10 bags × 50 tubes)	□ colorless 0030 123.611
PCR clean, 1,000 tubes	□ colorless 0030 123.328
<b>Eppendorf Safe-Lock Tubes, 2.0 mL</b>	
Eppendorf Quality™, 1,000 tubes	□ colorless 0030 120.094
Eppendorf Quality™, 1,000 tubes	■ yellow 0030 120.205
Eppendorf Quality™, 1,000 tubes	■ red 0030 120.213
Eppendorf Quality™, 1,000 tubes	■ blue 0030 120.221
Eppendorf Quality™, 1,000 tubes	■ green 0030 120.230
Eppendorf Quality™, 1,000 tubes	■ amber (light protection) 0030 120.248
Eppendorf Quality™, 1,000 tubes	assorted colors (per 200) 0030 121.686
Eppendorf Biopur®, 100 tubes, individually packed	□ colorless 0030 121.597
Forensic DNA Grade, 500 tubes (10 bags × 50 tubes)	□ colorless 0030 123.620
PCR clean, 1,000 tubes	□ colorless 0030 123.344
<b>Eppendorf Tube Rack, 36 positions, for 1.5 mL and 2.0 mL tubes, 2 pcs., polypropylene, numbered positions, autoclavable</b>	
<b>Storage Box 8 × 8</b> , for 64 tubes 1 – 2 mL, 3 pcs., height 53 mm, 2 inch, polypropylene, for freezing to -86 °C, autoclavable, with lid and alphanumeric code	0030 119.819 0030 140.524

i For more information go to [www.eppendorf.com/SafeLock](http://www.eppendorf.com/SafeLock)

# Eppendorf Tubes® 5.0 mL

## Description

Eppendorf Tubes are the benchmark for simple and safe sample preparation from 0.5 to 2.0 mL. For larger volumes, 15 mL and 50 mL conical tubes are available. With medium sample volumes you may face an issue: they need to be processed with large conical screw cap tubes - impractical, inconvenient and often prone to contamination. The availability of snap cap and screw cap formats enable the optimal choice for different requirements in sample preparation, incubation, storage, or other applications.



## Product features

- > Matching high-speed rotors for Eppendorf Centrifuges 5430/R, 5427 R, 5804/R and 5810/R
- > 5.0 mL adapters and inserts for all existing Eppendorf rotors, with bore holes for 15 mL or 50 mL tubes
- > Functional rack for bench work
- > Storage boxes for freezing
- > 5.0 mL thermoblocks for Eppendorf ThermoMixer® C, Eppendorf Thermomixer® comfort, ThermoStat C and ThermoStat plus
- > 5.0 mL Reservoir Rack Module for the automated pipetting system epMotion
- > Available in Eppendorf Protein and DNA LoBind material for maximum recovery of valuable samples when only low sample amount is available

## Applications

- > Easier processing of samples up to 5.0 mL
- > Higher yields in DNA isolation, especially with samples with limited quantity of source material
- > Convenient and safe cell culture applications
- > Easier sample access lowers the risk of contamination
- > Preparation of mastermixes and buffers
- > Less storage space needed
- > Safe cell and tissue lysis
- > Storage of samples and liquid solutions

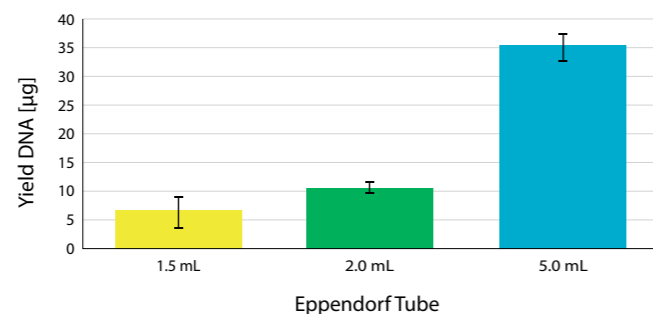

## Higher yields in DNA isolation

e.g. the yield of low-copy plasmid DNA can be significantly improved by increasing the culture volume to 5 mL. Data shown in the diagram were generated with 5.0 mL snap cap format – for additional information and protocol description please see Application Note 262.

For more information go to [www.eppendorf.com/5mL](http://www.eppendorf.com/5mL)



The ideal solution for sample preparation and storage: The new Eppendorf Tube Racks and Storage Boxes (see page 120 and 121).

## Ordering information

Description	Order no.
<b>Eppendorf Tubes® 5.0 mL, 5.0 mL</b>	
Eppendorf Quality™, colorless, 200 tubes (2 bags × 100 tubes)	0030 119.401
PCR clean, colorless, 200 tubes (2 bags × 100 tubes)	0030 119.460
Eppendorf Biopur®, colorless, 50 tubes, individually wrapped	0030 119.479
Forensic DNA Grade, colorless, 200 tubes (4 bags × 50 tubes)	0030 119.606
Sterile, colorless, 200 tubes (10 bags × 20 tubes)	0030 119.487
Eppendorf Quality™, amber (light protection), 200 tubes (2 bags × 100 tubes)	0030 119.452
<b>Eppendorf Tubes® 5.0 mL starter pack</b> , 5.0 mL, 400 tubes (2 packages with 2 bags of 100 each), 2 racks (with 12 locations each), white, 8 universal adapters for rotors with bore holes for 15 mL conical tubes, PCR clean, colorless	0030 119.380
<b>Eppendorf Tubes® 5.0 mL with screw cap</b> , 5.0 mL	
Eppendorf Quality™, colorless, 200 tubes (2 bags × 100 tubes)	0030 122.305
PCR clean, colorless, 200 tubes (2 bags × 100 tubes)	0030 122.313
Sterile, pyrogen-, DNase-, RNase-, human and bacterial DNA-free, colorless, 200 tubes (2 bags × 100 tubes)	0030 122.321
Forensic DNA Grade, colorless, 200 tubes (4 bags × 50 tubes)	0030 122.402
<b>DNA LoBind Tubes</b> , DNA LoBind, 5.0 mL, conical tubes, PCR clean, colorless, 200 tubes (4 bags × 50 tubes)	0030 108.310
<b>Protein LoBind Tubes</b> , Protein LoBind, 5.0 mL, PCR clean, colorless, 100 tubes (2 bags × 50 tubes)	0030 108.302
<b>Tube Clip for Eppendorf Tubes® 5.0 mL</b> , 5.0 mL, Eppendorf Quality™, 10 pcs.	0030 119.509
<b>Eppendorf Tube Rack</b> , 12 positions, for 5.0 mL and 15 mL tubes, 2 pcs., polypropylene, numbered positions, autoclavable	0030 119.827
<b>Storage Box 5 × 5</b> , for 25 tubes 5 mL, 4 pcs., height 64 mm, 2.5 inch, polypropylene, for freezing to -86 °C, autoclavable, with lid and alphanumeric code	0030 140.532
<b>Storage Box 5 × 5</b> , for 25 tubes 5 mL screw cap, 2 pcs., height 76 mm, 3 inch, polypropylene, for freezing to -86 °C, autoclavable, with lid and alphanumeric code	0030 140.613
<b>Rotor FA-45-12-17</b> , aerosol-tight, incl. rotor lid, for 12 × Eppendorf Tubes® 5.0 mL	5409 700.006
<b>Rotor FA-45-16-17</b> , aerosol-tight, incl. rotor lid, for 16 × Eppendorf Tubes® 5.0 mL	5427 750.002
<b>Rotor FA-45-20-17</b> , incl. rotor lid, for 20 × Eppendorf Tubes® 5.0 mL	5820 765.003
<b>Adapter</b> , for 14 × Eppendorf Tubes® 5.0 mL, for Rotor S-4-104, set of 2 pcs.	5825 739.000
<b>Adapter</b> , for 1 × Eppendorf Tubes® 5.0 mL, for Rotor A-4-38, set of 2 pcs.	5702 733.008
<b>Adapter</b> , for 12 × Eppendorf Tubes® 5.0 mL, for Rotor F-35-6-30, large rotor bore, set of 2 pcs.	5427 747.001
<b>Adapter</b> , for 1 × Eppendorf Tubes® 5.0 mL, for Rotor F-34-6-38, set of 2 pcs.	5804 777.000
<b>Adapter</b> , for Eppendorf Tubes® 5.0 mL, for Rotor F-35-6-30, small rotor bore, set of 2 pcs.	5427 746.005
<b>Adapter</b> , for 1 × Eppendorf Tubes® 5.0 mL, for Rotor FA-45-6-30, set of 2 pcs.	5820 730.005
<b>Universal adapter</b> , for 1 × Eppendorf Tubes® 5.0 mL, for centrifuges with rotors for conical 15 mL tubes, set of 8 pcs.	5820 732.008
<b>Adapter</b> , for 8 × Eppendorf Tubes® 5.0 mL, for Rotor S-4-72, set of 2 pcs.	5804 793.005
<b>Exchangeable thermoblocks</b> , for 8 × 5.0 mL Eppendorf Tubes®	5309 000.333
<b>Eppendorf SmartBlock™ 5 mL</b> , thermoblock for 8 Eppendorf Tubes® 5.0 mL, 8 × 5.0 mL reaction vessels	5309 000.007
<b>Reservoir Rack Module TC</b> , for use in epMotion® Reservoir Racks, temperable	
4 × Eppendorf Tubes® 5.0 mL	5075 799.340

# Eppendorf Conical Tubes 15 mL and 50 mL

## Description

The Conical Tubes 15 mL and 50 mL extend the volume range of the Eppendorf Tubes®. Safe design and easy handling ensure best sample processing. They represent the optimal solution for cell culture and cell biology applications as well as for sample preparation protocols in microbiology and molecular biology laboratories. Whether centrifugation, mixing, or other applications – the Eppendorf Conical Tubes 15 mL and 50 mL will perfectly fit into your workflows.

### Premium raw material and no use of slip agents, plasticizers, and biocides during manufacturing ensure

- > highest sample integrity
- > high g-Safe® centrifugation stability
- > optimal sample and pellet visibility

### Cap with flattened and grooved sides

- > supports user-friendly ergonomic handling
- > enables a stable upright positioning
- > minimizes contamination risk

### Reliable and safe labeling due to a large writing area on the tube and due to a flat and light-colored cap

### Precise dimensions enable maximum compatibility with centrifuge rotors, mixers and shakers

### Certified purity

- > individual purity certificates are available for each lot

### Applications

- > Convenient and safe cell culture applications
- > Sample preparation in microbiology and molecular biology labs
- > Storage of samples and solution with larger volumes
- > Preparation of mastermixes and buffers

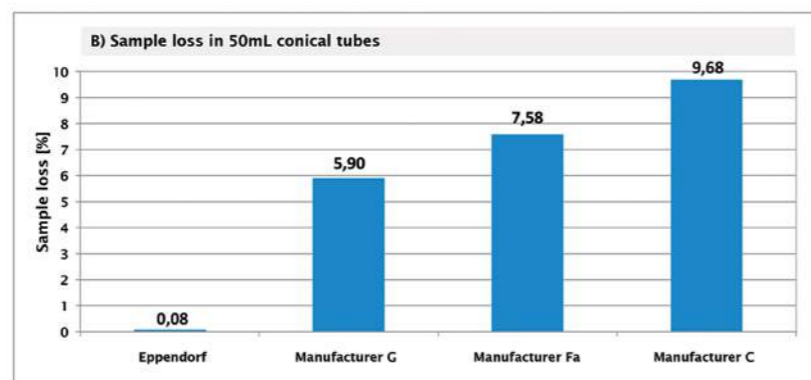

Figure 2: Sample loss after horizontal storage of ethanol in different conical tubes at -86 °C for 24 hours. Sample loss is expressed as percentage of initial weight before storage. For more information see Application Note 343.



Eppendorf Tubes® 5.0 mL with snap cap or screw cap: The ideal complement for smaller volumes (see page 106)

Whether centrifugation, mixing, or other applications – the Eppendorf Conical Tubes 15 and 50 mL will perfectly fit into your workflows

Technical specifications		
Model	Eppendorf Conical Tubes 15 mL	Eppendorf Conical Tubes 50 mL
External height / Dimensions external	121 mm / 17 mm	116 mm / 30 mm
Operating temperature	-86 °C – 100 °C	-86 °C – 100 °C

### Ordering information

Description	Order no.
<b>Eppendorf Conical Tubes, 15 mL</b>	
Sterile, pyrogen-, DNase-, RNase-, human and bacterial DNA-free, colorless, 500 tubes (10 bags x 50 tubes)	0030 122.151
Sterile, pyrogen-, DNase-, RNase-, human and bacterial DNA-free, amber (light protection), 200 tubes (4 bags x 50 tubes)	0030 122.194
Forensic DNA Grade, colorless, 100 tubes, individually wrapped	0030 122.259
Sterile, pyrogen-, DNase-, RNase-, human and bacterial DNA-free, colorless, 500 tubes (20 racks x 25 tubes)	0030 122.160
<b>Eppendorf Conical Tubes, 50 mL</b>	
Sterile, pyrogen-, DNase-, RNase-, human and bacterial DNA-free, colorless, 500 tubes (20 bags x 25 tubes)	0030 122.178
Sterile, pyrogen-, DNase-, RNase-, human and bacterial DNA-free, amber (light protection), 200 tubes (4 bags x 50 tubes)	0030 122.224
Forensic DNA Grade, colorless, 48 tubes, individually wrapped	0030 122.267
Sterile, pyrogen-, DNase-, RNase-, human and bacterial DNA-free, colorless, 300 tubes (12 racks x 25 tubes)	0030 122.186
<b>Eppendorf Tube Rack, 12 positions, 6 for 5.0 mL and 15 mL tubes and 6 for 50 mL tubes, 2 pcs., polypropylene, numbered positions, autoclavable</b>	0030 119.835
<b>Eppendorf Tube Rack, 12 positions, for 5.0 mL and 15 mL tubes, 2 pcs., polypropylene, numbered positions, autoclavable</b>	0030 119.827
<b>DNA LoBind Tubes, DNA LoBind, 15 mL, conical tubes, PCR clean, colorless, 200 tubes (4 bags x 50 tubes)</b>	0030 122.208
<b>DNA LoBind Tubes, DNA LoBind, 50 mL, conical tubes, PCR clean, colorless, 200 tubes (4 bags x 50 tubes)</b>	0030 122.232
<b>Protein LoBind Tubes, Protein LoBind, 15 mL, PCR clean, colorless, 200 tubes (4 bags x 50 tubes)</b>	0030 122.216
<b>Protein LoBind Tubes, Protein LoBind, 50 mL, PCR clean, colorless, 200 tubes (4 bags x 50 tubes)</b>	0030 122.240
<b>Storage Box 5 x 5, for 25 tubes 15 mL, 2 pcs., height 127 mm, 5 inch, polypropylene, for freezing to -86 °C, autoclavable, with lid and alphanumeric code</b>	0030 140.583
<b>Storage Box 3 x 3, for 9 tubes 50 mL and 4 tubes 15 mL, 2 pcs., height 127 mm, 5 inch, polypropylene, for freezing to -86 °C, autoclavable, with lid and alphanumeric code</b>	0030 140.591

# Eppendorf Microplates

## Description

The Eppendorf Microplates bring an outstanding clarity to your laboratory! It has never been this easy to pipette, control and recover samples with a polypropylene microplate. The easy-to-read alphanumeric label of the OptiTrack® matrix on each plate makes it unbelievably easy to identify individual wells, speeds up the filling process and significantly reduces the risk of errors. The high transparency is "one-of-a-kind" and ensures that you can always quickly locate your samples. The Microplates are also available in Eppendorf LoBind material for maximum sample recovery when only limited amount of sample material is available.

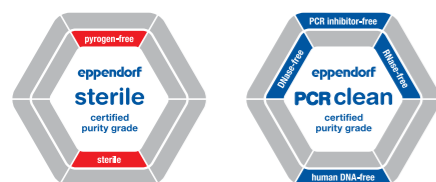

## Product features

- > Unmatched, transparent polypropylene (PP) for improved sample visibility
- > OptiTrack® Matrix: up to 30 % faster sample identification and fewer pipetting errors via high-contrast alphanumeric labeling
- > RecoverMax® well design: Optimized well geometry for minimal remaining volume and excellent mixing properties
- > Raised well rims and smooth surface for reliable closing, even with heat sealing
- > g-Safe®: exceptional centrifugation stability up to 6,000 × g
- > Polypropylene guarantees high resistance to chemicals, mechanical stress and temperature extremes
- > Manufactured without slip agents, plastocizers or biocides – Materials which could have a negative effect on bioassays
- > Guaranteed functionality from -86 °C to 100 °C
- > Autoclavable (121 °C, 20 min)
- > Available with barcode. Additional details available at: [www.eppendorf.com/barcode](http://www.eppendorf.com/barcode)

## Applications

- > Sample storage and preparation
- > Assays that require high resistance against temperature or solvents
- > Active ingredient screening
- > Combinatorial chemistry
- > Storage of cDNA or genomic banks
- > Protein analysis
- > Genotyping
- > Storage of siRNA or oligonucleotide libraries
- > Preparation of tissue and plant lysates

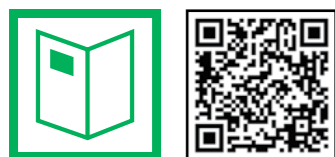





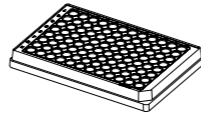
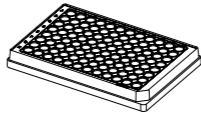
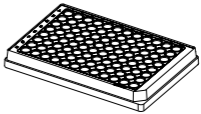
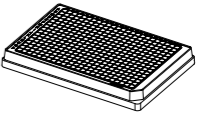
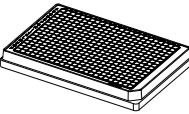

[www.eppendorf.com/microplates-brochure](http://www.eppendorf.com/microplates-brochure)

i For more information go to [www.eppendorf.com/consumables](http://www.eppendorf.com/consumables)

Technical specifications subject to change.

## Technical specifications

					
<b>Description</b>	<b>Microplate 96/F</b>	<b>Microplate 96/U</b>	<b>Microplate 96/V</b>	<b>Microplate 384/F</b>	<b>Microplate 384/V-PP</b>
<b>Number of wells</b>	96 wells	96 wells	96 wells	384 wells	384 wells
<b>Working volume</b>	50 – 350 µL	20 – 320 µL	20 – 320 µL	10 – 120 µL	5 – 120 µL
<b>Total volume per well</b>	400 µL	360 µL	350 µL	150 µL	140 µL
					
<b>Bottom shape</b>	flat	round	conical	flat	conical

## Ordering information

Description	OptiTrack® frame color	Order no.
<b>Microplate 96/F</b> , wells clear, RecoverMax® well design		
PCR clean, 80 plates (5 bags × 16 plates)	<input type="checkbox"/> white	0030 601.106
Sterile, 80 plates (5 bags × 16 plates)	<input type="checkbox"/> white	0030 602.102
<b>Microplate 96/U</b> , wells clear, RecoverMax® well design		
PCR clean, 80 plates (5 bags × 16 plates)	<input type="checkbox"/> white	0030 601.203
Sterile, 80 plates (5 bags × 16 plates)	<input type="checkbox"/> white	0030 602.200
<b>Microplate 96/V</b> , wells clear, RecoverMax® well design		
PCR clean, 80 plates (5 bags × 16 plates)	<input type="checkbox"/> white	0030 601.300
Sterile, 80 plates (5 bags × 16 plates)	<input type="checkbox"/> white	0030 602.307
<b>Microplate 384/F</b> , wells clear, RecoverMax® well design		
PCR clean, 80 plates (5 bags × 16 plates)	<input type="checkbox"/> white	0030 621.107
Sterile, 80 plates (5 bags × 16 plates)	<input type="checkbox"/> white	0030 622.103
<b>Microplate 384/V</b> , wells clear, RecoverMax® well design		
PCR clean, 80 plates (5 bags × 16 plates)	<input type="checkbox"/> white	0030 621.301
Sterile, 80 plates (5 bags × 16 plates)	<input type="checkbox"/> white	0030 622.308

Your local distributor: [www.eppendorf.com/contact](http://www.eppendorf.com/contact)

Eppendorf AG · Barkhausenweg 1 · 22339 Hamburg · Germany · [eppendorf@eppendorf.com](mailto:eppendorf@eppendorf.com) · [www.eppendorf.com](http://www.eppendorf.com)



# Eppendorf Assay/Reader Microplates

## Description

Eppendorf assay plates are optimized for measuring absorbance assays in the visible and UV range, fluorescence and chemiluminescence assays. Solid plates are suitable for top-reading plate readers. Clear plates and black/clear plates can be used with top- and bottom-reading plate readers.

The black Eppendorf Microplates are ideal for fluorescence detection. An excellent signal-to-noise ratio provides low detection limits in assays – for clear signals even with low-concentration samples! The white Eppendorf Microplates maximize reflection for high sensitivity during detection of luminescence or weak fluorescence signals.

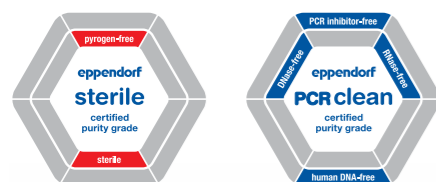

## Product features

- > UV-VIS Microplates feature an ultrathin film bottom for excellent light transmission in the UV range
- > Black Eppendorf Microplates offer an excellent signal-to-noise ratio – for clear signals even with low-concentration samples
- > White Eppendorf Microplates are optimized for highest sensitivity in the detection of luminescence signals by maximizing reflection
- > Solid black and white assay plates are made of polypropylene resulting in high resistance to chemicals, mechanical stress, and temperature extremes
- > All plates are optimized for minimal autofluorescence and autoluminescence
- > Available in lot-certified sterile or PCR clean purity grade

## Applications

- > Clear VIS and UV-VIS plates for all absorbance assays in the visible and UV range
- > Black and white Microplates for Fluorescence and Luminescence detection
- > DNA- and Protein concentration with absorbance or fluorescent dyes
- > Cell based assays
- > Cell viability and apoptosis assays
- > Cell imaging
- > Protocols that require high resistance against temperature or solvents
- > Dilution series
- > Preparation of tissue and plant lysates

For more information go to [www.eppendorf.com/consumables](http://www.eppendorf.com/consumables)

Technical specifications subject to change.

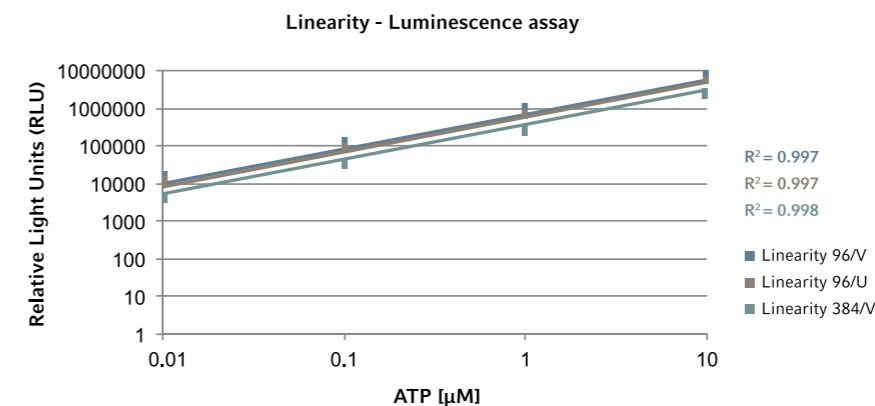

The Eppendorf Microplates 96/V, 96/U and 384/V were tested in a luminescence assay. A ten-fold serial dilution of ATP in culture medium was prepared. Logarithmic plot of data showing linearity of results for the Eppendorf Microplates in the range between 0.01 and 10 µM ATP. For more information see Application Note 215.

## Ordering information

Description	Order no.
<b>Microplate 96/F</b> , wells white	
PCR clean, border gray, 80 plates (5 bags × 16 plates)	0030 601.475
<b>Microplate 96/U</b> , wells white	
PCR clean, border gray, 80 plates (5 bags × 16 plates)	0030 601.572
<b>Microplate 96/V</b> , wells white	
PCR clean, border gray, 80 plates (5 bags × 16 plates)	0030 601.670
<b>Microplate 384/V</b> , wells white	
PCR clean, border gray, 80 plates (5 bags × 16 plates)	0030 621.670
<b>Microplate 96/F</b> , wells black	
PCR clean, border white, 80 plates (5 bags × 16 plates)	0030 601.700
<b>Microplate 96/U</b> , wells black	
PCR clean, border white, 80 plates (5 bags × 16 plates)	0030 601.807
<b>Microplate 96/V</b> , wells black	
PCR clean, border white, 80 plates (5 bags × 16 plates)	0030 601.904
<b>Microplate 384/V</b> , wells black	
PCR clean, border white, 80 plates (5 bags × 16 plates)	0030 621.905
<b>Microplate UV-VIS 96/F</b> , wells clear	
PCR clean, border colorless, 40 plates (4 bags × 10 plates)	0030 741.048
<b>Microplate VIS 96/F</b> , wells clear	
PCR clean, border colorless, 40 plates (4 bags × 10 plates)	0030 730.020
<b>Eppendorf Cell Imaging Plates</b> , with lid, black with clear F-bottom. Sterile, pyrogen-, DNase-, RNase-, human and bacterial DNA-free. Non-cytotoxic	
TC treated, 96-Well Cell Imaging Plate with 25 µm film bottom, individually wrapped, 20 pcs.	0030 741.013

Your local distributor: [www.eppendorf.com/contact](http://www.eppendorf.com/contact)

Eppendorf AG · Barkhausenweg 1 · 22339 Hamburg · Germany · [eppendorf@eppendorf.com](mailto:eppendorf@eppendorf.com) · [www.eppendorf.com](http://www.eppendorf.com)

# Eppendorf Deepwell Plates

## Description

Eppendorf Deepwell Plates 96 and 384 are high-performance plates for all manual and automated applications – from sample storage at -86 °C to DNA denaturation at 100 °C. Manufactured from pure polypropylene (PP), these plates offer innovative features: More dependability. More efficiency. More stability. The plates are available with a white, yellow, green, or blue border. For easy identification of wells, a high-contrast alphanumeric label is laser-engraved in the border. This OptiTrack® matrix allows you to find your sample up to 30 % more quickly while reducing pipetting errors. With all of these sophisticated features, these plates set new standards in your laboratory.

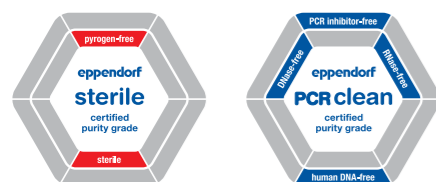

## Applications

- > Sample storage and preparation
- > Bacteria and yeast cultivation
- > DNA and RNA isolation with high throughput
- > Storage of cDNA or genomic banks
- > Storage of siRNA or oligonucleotide libraries
- > Protein analysis
- > Storage of valuable protein and DNA samples in Eppendorf LoBind plates
- > Plasmid purification with high throughput
- > Creating dilution series

## Product features

- > OptiTrack® matrix: up to 30 % faster sample identification and fewer pipetting errors via high-contrast alphanumeric labeling
- > RecoverMax® well design: Optimized well geometry for maximum sample recovery and excellent mixing properties
- > Minimal remaining volume and high uniformity from well to well
- > Raised well rims and smooth surface for reliable closing, even with heat sealing
- > Easy and reliable stacking
- > g-Safe®: exceptional centrifugation stability up to 6,000 × g for faster protocols and improved sample quality
- > High-quality polypropylene guarantees high resistance to chemicals, mechanical stress and temperature extremes
- > Manufactured without slip agents, plasticizers, and biocides – Materials which could have a negative effect on bioassays
- > Autoclavable (121 °C, 20 min)
- > Available with barcode. Additional details available at: [www.eppendorf.com/barcode](http://www.eppendorf.com/barcode)

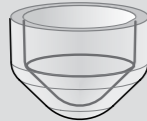
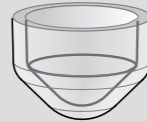
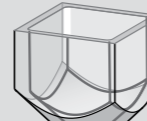
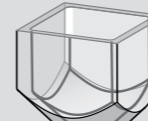
Technical specifications				
Model	Deepwell Plates 96/500 µL	Deepwell Plates 96/1000 µL	Deepwell Plates 96/2000 µL	Deepwell Plates 384/200 µL
Total volume per well	700 µL	1,200 µL	2,400 µL	240 µL
Working volume per well	30 – 550 µL	30 – 1 000 µL	50 – 2 000 µL	20 – 225 µL
Well shape/Bottom shape				

For more information go to [www.eppendorf.com/Deepwellplates](http://www.eppendorf.com/Deepwellplates)

Technical specifications subject to change.

## Ordering information

Description	OptiTrack® frame color	Order no.
<b>Deepwell Plate 96/500 µL, wells clear, 500 µL</b>		
PCR clean, 40 plates (5 bags × 8 plates)	white	0030 501.101
PCR clean, 40 plates (5 bags × 8 plates)	yellow	0030 501.110
PCR clean, 40 plates (5 bags × 8 plates)	green	0030 501.136
PCR clean, 40 plates (5 bags × 8 plates)	blue	0030 501.144
PCR clean, 120 plates (10 bags × 12 plates)	white	0030 505.107
Sterile, 40 plates (5 bags × 8 plates)	white	0030 502.108
Sterile, 40 plates (5 bags × 8 plates)	yellow	0030 502.116
Sterile, 40 plates (5 bags × 8 plates)	green	0030 502.132
Sterile, 40 plates (5 bags × 8 plates)	blue	0030 502.140
Sterile, 120 plates (10 bags × 12 plates)	white	0030 506.103
<b>Deepwell Plate 96/1000 µL, wells clear, 1,000 µL</b>		
PCR clean, 20 plates (5 bags × 4 plates)	white	0030 501.209
PCR clean, 20 plates (5 bags × 4 plates)	yellow	0030 501.217
PCR clean, 20 plates (5 bags × 4 plates)	green	0030 501.233
PCR clean, 20 plates (5 bags × 4 plates)	blue	0030 501.241
PCR clean, 80 plates (10 bags × 8 plates)	white	0030 505.204
Sterile, 20 plates (5 bags × 4 plates)	white	0030 502.205
Sterile, 20 plates (5 bags × 4 plates)	yellow	0030 502.213
Sterile, 20 plates (5 bags × 4 plates)	green	0030 502.230
Sterile, 20 plates (5 bags × 4 plates)	blue	0030 502.248
Sterile, 80 plates (10 bags × 8 plates)	white	0030 506.200
<b>Deepwell Plate 96/2000 µL, wells clear, 2,000 µL</b>		
PCR clean, 20 plates (5 bags × 4 plates)	white	0030 501.306
PCR clean, 20 plates (5 bags × 4 plates)	yellow	0030 501.314
PCR clean, 20 plates (5 bags × 4 plates)	green	0030 501.330
PCR clean, 20 plates (5 bags × 4 plates)	blue	0030 501.349
PCR clean, 80 plates (10 bags × 8 plates)	white	0030 505.301
Sterile, 20 plates (5 bags × 4 plates)	white	0030 502.302
Sterile, 20 plates (5 bags × 4 plates)	yellow	0030 502.310
Sterile, 20 plates (5 bags × 4 plates)	green	0030 502.337
Sterile, 20 plates (5 bags × 4 plates)	blue	0030 502.345
Sterile, 80 plates (10 bags × 8 plates)	white	0030 506.308
<b>Deepwell Plate 384/200 µL, wells clear, 200 µL</b>		
PCR clean, 40 plates (5 bags × 8 plates)	white	0030 521.102
PCR clean, 120 plates (10 bags × 12 plates)	white	0030 525.108
Sterile, 40 plates (5 bags × 8 plates)	white	0030 522.109
Sterile, 120 plates (10 bags × 12 plates)	white	0030 526.104



[www.eppendorf.com/deepwellplates-brochure](http://www.eppendorf.com/deepwellplates-brochure)

Your local distributor: [www.eppendorf.com/contact](http://www.eppendorf.com/contact)  
Eppendorf AG · Barkhausenweg 1 · 22339 Hamburg · Germany · [eppendorf@eppendorf.com](mailto:eppendorf@eppendorf.com) · [www.eppendorf.com](http://www.eppendorf.com)

# Protein LoBind Plates

## Description

Eppendorf LoBind Plates maximize sample recovery by significantly reducing sample binding to the surface. A special, two-component polymer mix creates a hydrophilic surface that guarantees optimal recovery rates of valuable samples. Protein LoBind Plates have been specially designed for use in protein research or with sensitive proteomic test methods, and frequently provide significantly improved analysis results.

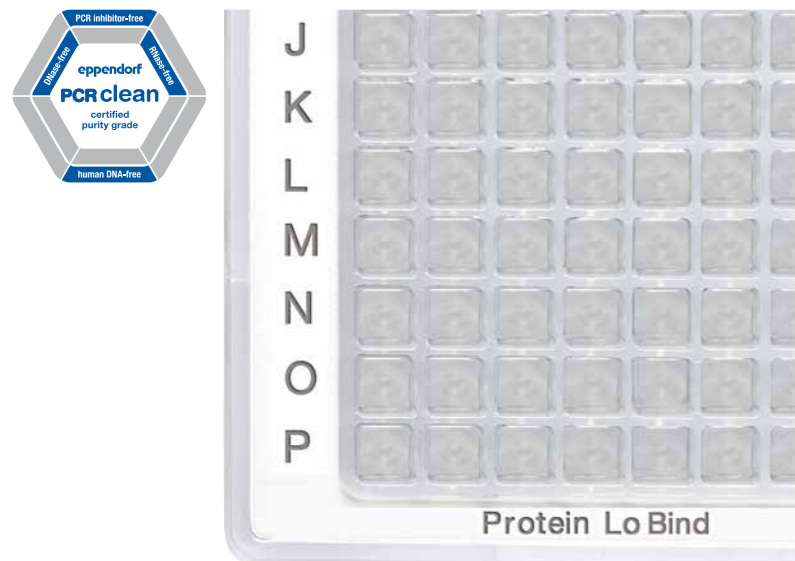

## Product features

- > Eppendorf LoBind material guarantees maximum sample recovery for improved assay results
- > Free of surface coating (e.g., silicone) to minimize the risk of sample interference
- > Lot-certified PCR clean purity grade: free of human DNA, DNase, RNase and PCR inhibitors
- > Available in tube, microplate, and deepwell plate formats for easy-up scaling
- > High-contrast Unique OptiTrack® matrix: up to 30 % faster sample identification and fewer pipetting errors
- > RecoverMax® well design: optimized well geometry for minimal remaining/dead volume and excellent mixing properties
- > Raised well rims and a smooth surface guarantee reliable sealing in plates
- > Available with barcode. Additional details available at: [www.eppendorf.com/barcode](http://www.eppendorf.com/barcode)

## Applications

- > Preparation or storage of protein, peptide or antibody samples
- > Enzymatic assays – the hydrophilic surface reduces denaturation when it comes into contact with the tube inner wall
- > Prevention of sample loss during storage of virus stock solutions
- > Storage of cell suspensions

## Ordering information

Description	OptiTrack® frame color	Order no.
<b>Deepwell Plate 96/500 µL, Protein LoBind, 500 µL</b>		
PCR clean, 40 plates (5 bags × 8 plates)	<input type="checkbox"/> white	0030 504.100
PCR clean, 40 plates (5 bags × 8 plates)	<input checked="" type="checkbox"/> yellow	0030 504.119
PCR clean, 120 plates (10 bags × 12 plates)	<input type="checkbox"/> white	0030 508.106
<b>Deepwell Plate 96/1000 µL, Protein LoBind, 1,000 µL</b>		
PCR clean, 20 plates (5 bags × 4 plates)	<input type="checkbox"/> white	0030 504.208
PCR clean, 20 plates (5 bags × 4 plates)	<input checked="" type="checkbox"/> yellow	0030 504.216
PCR clean, 80 plates (10 bags × 8 plates)	<input type="checkbox"/> white	0030 508.203
<b>Deepwell Plate 96/2000 µL, Protein LoBind, 2,000 µL</b>		
PCR clean, 20 plates (5 bags × 4 plates)	<input type="checkbox"/> white	0030 504.305
<b>Deepwell Plate 384/200 µL, Protein LoBind, 200 µL</b>		
PCR clean, 40 plates (5 bags × 8 plates)	<input type="checkbox"/> white	0030 524.101
PCR clean, 120 plates (10 bags × 12 plates)	<input type="checkbox"/> white	0030 528.107
<b>Microplate 384/V-PP, Protein LoBind, wells clear</b>		
PCR clean, 80 plates (5 bags × 16 plates)	<input type="checkbox"/> white	0030 624.300
PCR clean, 240 plates (10 bags × 24 plates)	<input type="checkbox"/> white	0030 628.306

# Protein LoBind Tubes

## Description

When biological samples are stored or incubated in standard vessels, over 90 % of the sample can be lost within 24 hours as a result of binding to the plastic surface. Eppendorf LoBind Tubes maximize sample recovery by significantly reducing sample binding to the surface. A special, two-component polymer mix creates a hydrophilic surface that guarantees optimal recovery rates of valuable samples. Protein LoBind Tubes have been specially designed for use in protein research or with sensitive proteomic test methods, and frequently provide significantly improved analysis results.

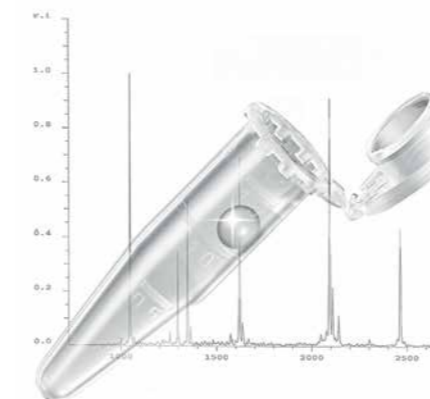

## Product features

- > Eppendorf LoBind material guarantees maximum sample recovery for improved assay results
- > Free of surface coating (e.g., silicone) to minimize the risk of sample interference
- > Lot-certified PCR clean purity grade: free of human DNA, DNase, RNase and PCR inhibitors
- > Available in tube, microplate, and deepwell plate formats for easy-up scaling
- > Precise lid sealing to minimize evaporation

## Applications

- > Preparation or storage of protein, peptide or antibody samples
- > Enzymatic assays – the hydrophilic surface reduces denaturation when it comes into contact with the tube inner wall
- > Prevention of sample loss during storage of virus stock solutions
- > Storage of cell suspensions

## Ordering information

Description	Order no.
<b>Protein LoBind Tubes</b> , Protein LoBind, 0.5 mL, PCR clean, colorless, 100 tubes (2 bags × 50 tubes)	0030 108.094
<b>Protein LoBind Tubes</b> , Protein LoBind, 1.5 mL, PCR clean, colorless, 100 tubes (2 bags × 50 tubes)	0030 108.116
<b>Protein LoBind Tubes</b> , Protein LoBind, 2.0 mL, PCR clean, colorless, 100 tubes (2 bags × 50 tubes)	0030 108.132
<b>Protein LoBind Tubes</b> , Protein LoBind, 5.0 mL, PCR clean, colorless, 100 tubes (2 bags × 50 tubes)	0030 108.302
<b>Protein LoBind Tubes</b> , Protein LoBind, 15 mL, PCR clean, colorless, 200 tubes (4 bags × 50 tubes)	0030 122.216
<b>Protein LoBind Tubes</b> , Protein LoBind, 50 mL, PCR clean, colorless, 200 tubes (4 bags × 50 tubes)	0030 122.240

## DNA LoBind Plates

### Description

DNA LoBind plates improve recovery of nucleic acids by reducing their adsorption to the tube wall. A combination of special manufacturing technologies and selected polypropylene batches ensures nearly 100 % recovery of DNA/RNA molecules-without surface coating to eliminate the risk of sample contamination. Eppendorf DNA LoBind plates are ideal for sample preparation of long-term storage of nucleic acids in forensic, microarrays, NGS applications, and many others.

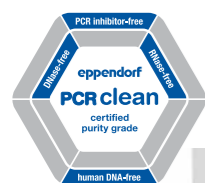

### Product features

- > Eppendorf LoBind material guarantees maximum sample recovery for improved assay results
- > Free of surface coating (e.g. silicone) to minimize the risk of sample interference
- > Lot-certified PCR clean purity grade: free of human DNA, DNase, RNase and PCR inhibitors
- > Available in tube, microplate, and deepwell plate formats for easy-up scaling
- > High-contrast Unique OptiTrack® matrix: up to 30 % faster sample identification and fewer pipetting errors
- > RecoverMax® well design: optimized well geometry for minimal remaining/dead volume and excellent mixing properties
- > Raised well rims and a smooth surface guarantee reliable sealing
- > Available with barcode. Additional details available at: [www.eppendorf.com/barcode](http://www.eppendorf.com/barcode)

### Applications

- > Preparation or storage of DNA and RNA samples
- > Forensic trace analysis
- > Preparing dilution series in quantitative qPCR
- > Sample preparation in next-generation sequencing
- > Creation of genomic or oligonucleotide libraries

### Ordering information

Description	OptiTrack® frame color	Order no.
<b>Deepwell Plate 96/500 µL, DNA LoBind, 500 µL, Eppendorf LoBind®</b>		
PCR clean, 40 plates (5 bags × 8 plates)	<input type="checkbox"/> white	0030 503.104
PCR clean, 40 plates (5 bags × 8 plates)	<input checked="" type="checkbox"/> blue	0030 503.147
PCR clean, 120 plates (10 bags × 12 plates)	<input type="checkbox"/> white	0030 507.100
<b>Deepwell Plate 96/1000 µL, DNA LoBind, 1,000 µL, Eppendorf LoBind®</b>		
PCR clean, 20 plates (5 bags × 4 plates)	<input type="checkbox"/> white	0030 503.201
PCR clean, 20 plates (5 bags × 4 plates)	<input checked="" type="checkbox"/> blue	0030 503.244
PCR clean, 80 plates (10 bags × 8 plates)	<input type="checkbox"/> white	0030 507.207
<b>Deepwell Plate 384/200 µL, DNA LoBind, 200 µL, Eppendorf LoBind®</b>		
PCR clean, 40 plates (5 bags × 8 plates)	<input type="checkbox"/> white	0030 523.105
PCR clean, 120 plates (10 bags × 12 plates)	<input type="checkbox"/> white	0030 527.100
<b>Microplate 96/V-PP, DNA LoBind, Eppendorf LoBind®</b>		
PCR clean, 80 plates (5 bags × 16 plates)	<input type="checkbox"/> white	0030 603.303
<b>Microplate 384/V-PP, DNA LoBind, wells clear, Eppendorf LoBind®</b>		
PCR clean, 80 plates (5 bags × 16 plates)	<input type="checkbox"/> white	0030 623.304
PCR clean, 240 plates (10 bags × 24 plates)	<input type="checkbox"/> white	0030 627.300

## DNA LoBind Tubes

### Description

DNA LoBind tubes maximize sample recovery of nucleic acids by significantly reducing sample-to-surface binding. A combination of special manufacturing technologies and selected polypropylene batches ensures nearly 100 % recovery of DNA/RNA molecules-without surface coating to eliminate the risk of sample contamination. DNA LoBind tubes are batch-tested and certified by an independent laboratory to be free from DNA, DNase, RNase, and PCR inhibitors. Eppendorf DNA LoBind tubes are ideal for sample preparation of long-term storage of nucleic acids in forensic, microarrays, NGS applications, and many others.



### Product features

- > Eppendorf LoBind material guarantees maximum sample recovery for improved assay results
- > Free of surface coating (e.g., silicone) to minimize the risk of sample interference
- > Lot-certified PCR clean purity grade: free of human DNA, DNase, RNase and PCR inhibitors
- > Available in tube, microplate, and deepwell plate formats for easy-up scaling
- > Precise lid sealing for minimal evaporation rates in tube format
- > Rated up to 30,000 × g (25,000 × g for 2.0 mL tube) centrifugation speed for molecular biology applications

### Applications

- > Preparation or storage of DNA and RNA samples
- > Forensic trace analysis
- > Preparing dilution series in quantitative qPCR
- > Sample preparation in next-generation sequencing
- > Creation of genomic or oligonucleotide libraries

### Ordering information

Description	Order no.
<b>DNA LoBind Tubes, DNA LoBind, 0.5 mL, PCR clean, colorless, 250 tubes (5 bags × 50 tubes)</b>	0030 108.035
<b>DNA LoBind Tubes, DNA LoBind, 1.5 mL, PCR clean, colorless, 250 tubes (5 bags × 50 tubes)</b>	0030 108.051
<b>DNA LoBind Tubes, DNA LoBind, 2.0 mL, PCR clean, colorless, 250 tubes (5 bags × 50 tubes)</b>	0030 108.078
<b>DNA LoBind Tubes, DNA LoBind, 5.0 mL, conical tubes, PCR clean, colorless, 200 tubes (4 bags × 50 tubes)</b>	0030 108.310
<b>DNA LoBind Tubes, DNA LoBind, 15 mL, conical tubes, PCR clean, colorless, 200 tubes (4 bags × 50 tubes)</b>	0030 122.208
<b>DNA LoBind Tubes, DNA LoBind, 50 mL, conical tubes, PCR clean, colorless, 200 tubes (4 bags × 50 tubes)</b>	0030 122.232

# Accessories



## Sealing options for Sample Preparation and Storage

- > Storage Film and Foil glued seals for simple and dependable sealing during sample storage
- > Heat Sealing Film and Foil for continuous locking with the best evaporation protection
- > Foil products are made of aluminum, can be pierced, and protect light-sensitive samples
- > Film products are transparent and provide protection against unwanted punctures
- > Eppendorf Plate Lid: stable, flexible protection of samples during short-term storage

### Ordering information

Description	Order no.
<b>Eppendorf Storage Film</b> , self-adhesive, PCR clean, 100 pcs. (2 bags x 50 pcs.)	0030 127.870
<b>Eppendorf Storage Foil</b> , self-adhesive, PCR clean, 100 pcs.	0030 127.889
<b>Eppendorf Sealing Mat</b> , for DWP 96/2000, PCR clean, 50 pcs. (5 bags x 10 pcs.)	0030 127.960
<b>Eppendorf Sealing Mat</b> , for DWP 96/1000 and DWP 96/500, PCR clean, 50 pcs. (5 bags x 10 pcs.)	0030 127.978
<b>Eppendorf Plates® Lid</b> , for MTP and DWP, PCR clean, 80 pcs. (5 bags x 16 pcs.)	0030 131.517
<b>Eppendorf Plates® Lid</b> , for MTP and DWP, Sterile, 80 pcs. (5 bags x 16 pcs.)	0030 131.525
<b>Eppendorf Heat Sealing Film</b> , PCR clean, 100 pcs.	0030 127.838
<b>Eppendorf Heat Sealing Foil</b> , PCR clean, 100 pcs.	0030 127.854



## Eppendorf Storage Boxes

- > Made of polypropylene (PP) for high stability in freezing applications and smooth opening and closing
- > For freezing to -86 °C
- > High-contrast permanent alphanumeric marking of each location through laser labeling enables easy sample reference and minimizes risk of sample mix-up
- > Autoclavable (121 °C, 20 min)
- > Transparent lid for easy and fast sample inspection
- > Flexible labeling on the light colored box and on the 5 writing areas of the lid
- > Optimal use of freezer space due to flexible combination of the different formats
- > For more information see: [www.eppendorf.com/storageboxes](http://www.eppendorf.com/storageboxes)

### Ordering information

Description	Order no.
<b>Storage Box 10 x 10</b> , for 100 cryogenic tubes w. int. thread, 3 pcs., height 53 mm, 2 inch, polypropylene, for freezing to -86 °C, autoclavable, with lid and alphanumeric code	0030 140.508
<b>Storage Box 9 x 9</b> , for 81 screw cap (cryog.) tubes 1 – 2 mL, 3 pcs., height 53 mm, 2 inch, polypropylene, for freezing to -86 °C, autoclavable, with lid and alphanumeric code	0030 140.516
<b>Storage Box 9 x 9</b> , for 81 screw cap (cryog.) tubes 3 mL, 2 pcs., height 76 mm, 3 inch, polypropylene, for freezing to -86 °C, autoclavable, with lid and alphanumeric code	0030 140.540
<b>Storage Box 9 x 9</b> , for 81 screw cap (cryog.) tubes 4 – 5 mL, 2 pcs., height 102 mm, 4 inch, polypropylene, for freezing to -86 °C, autoclavable, with lid and alphanumeric code	0030 140.567
<b>Storage Box 8 x 8</b> , for 64 tubes 1 – 2 mL, 3 pcs., height 53 mm, 2 inch, polypropylene, for freezing to -86 °C, autoclavable, with lid and alphanumeric code	0030 140.524
<b>Storage Box 5 x 5</b> , for 25 tubes 5 mL, 4 pcs., height 64 mm, 2.5 inch, polypropylene, for freezing to -86 °C, autoclavable, with lid and alphanumeric code	0030 140.532
<b>Storage Box 5 x 5</b> , for 25 tubes 5 mL screw cap, 2 pcs., height 76 mm, 3 inch, polypropylene, for freezing to -86 °C, autoclavable, with lid and alphanumeric code	0030 140.613
<b>Storage Box 5 x 5</b> , for 25 tubes 15 mL, 2 pcs., height 127 mm, 5 inch, polypropylene, for freezing to -86 °C, autoclavable, with lid and alphanumeric code	0030 140.583
<b>Storage Box 3 x 3</b> , for 9 tubes 50 mL and 4 tubes 15 mL, 2 pcs., height 127 mm, 5 inch, polypropylene, for freezing to -86 °C, autoclavable, with lid and alphanumeric code	0030 140.591



## Micropestle

- > Two sides for optimal fit in 1.5 mL and 2.0 mL vessels
- > Autoclavable (121 °C, 20 min)

### Ordering information

Description	Order no.
<b>Micropestle</b> , for resuspending pellets in 1.5/2.0 mL vessels, 10 pcs.	0030 120.973



## Eppendorf Tube and Cuvette Racks

- > Made from high quality polypropylene (PP):
  - > Ensuring dimensional stability across a broad temperature range (-86 °C to 121° C)
  - > Providing chemical resistance
- > Six different formats always offer the optimal choice for all common tubes and cuvettes
- > A wavelike design enables you to clearly identify your samples, even when tubes are placed vertically in a column
- > Non-slip silicone feet ensure safe handling
- > The racks are laboratory washer-safe for fast and easy cleaning
- > The racks are autoclavable (121° C/20 min) and stackable
- > For more information see: [www.eppendorf.com/tube-racks](http://www.eppendorf.com/tube-racks)
- > Autoclavable (121 °C, 20 min)

### Ordering information

Description	Order no.
<b>Eppendorf Tube Rack</b> , 48 positions, for 0.5 mL tubes, 2 pcs., polypropylene, numbered positions, autoclavable	0030 119.800
<b>Eppendorf Tube Rack</b> , 36 positions, for 1.5 mL and 2.0 mL tubes, 2 pcs., polypropylene, numbered positions, autoclavable	0030 119.819
<b>Eppendorf Tube Rack</b> , 12 positions, for 5.0 mL and 15 mL tubes, 2 pcs., polypropylene, numbered positions, autoclavable	0030 119.827
<b>Eppendorf Tube Rack</b> , 12 positions, 6 for 5.0 mL and 15 mL tubes and 6 for 50 mL tubes, 2 pcs., polypropylene, numbered positions, autoclavable	0030 119.835
<b>Eppendorf Cuvette Rack</b> , 30 positions, for glass and plastic cuvettes, 2 pcs., polypropylene, numbered positions, autoclavable	0030 119.851
<b>Eppendorf Tube Rack</b> , 36 positions, for cryogenic tubes, 2 pcs., polypropylene, numbered positions, autoclavable	0030 119.843

# Sample Handling



Model	MiniSpin®/MiniSpin® plus	5418 R
Positioning	Entry-level	Medium capacity for molecular biology
Page(s)	126	127
Max. capacity	12 x 1.5/2.0 mL	18 x 1.5/2.0 mL
Max. RCF	12,100 x g/14,100 x g	16,873 x g
Max. speed	13,400 rpm/14,500 rpm	14,000 rpm
Rotors available	2	1
Temperature control range	-	0 °C to +40 °C
Dimensions (W x D x H)	22.6 x 23.9 x 12.0 cm	30 x 46 x 25 cm
Height (with open lid)	25 cm	52 cm
Weight w/o accessories	4.3 kg	22 kg
Max. power consumption	70 W/85 W	320 W
Tubes/plates capacity <sup>1)</sup>		
1.5/2.0 mL Eppendorf tubes	12	18
Eppendorf Tubes® 5.0 mL	-	-
8-place PCR strips	2	-
15 mL conical	-	-
50 mL conical	-	-
2.6 – 7 mL (13 mm)	-	-
3 – 15 mL (16 mm)	-	-
7 – 17 mL (17.5 mm)	-	-
MTP/PCR-plates	-	-
Deepwell plates (DWP)	-	-

<sup>1)</sup> F = Fixed-angle rotor, S = Swing-bucket rotor



Model	5425/5424 R	5427 R	5430/5430 R
Positioning	The new laboratory standard/The laboratory standard	High throughput	Microcentrifuge with multipurpose capabilities
Page(s)	128/129	130	131
Max. capacity	10 x 5 mL/24 x 1.5/2.0 mL	48 x 1.5/2.0 mL	48 x 1.5/2.0 mL, 6 x 50 mL, 2 x MTP
Max. RCF	21,330 x g/21,130 x g	25,000 x g	30,130 x g
Max. speed	15,060 rpm/15,000 rpm	16,220 rpm	17,500 rpm
Rotors available	6/4	9	12
Temperature control range	-10 °C to +40 °C	-11 °C to 40 °C	-11 °C to 40 °C
Dimensions (W x D x H)	24 x 39 x 24 cm/29 x 48 x 26 cm	31.9 x 54.0 x 25.4 cm	33 x 42 x 25 cm/38 x 64 x 29 cm
Height (with open lid)	48 cm/51 cm		56 cm/63 cm
Weight w/o accessories	15.6 kg/21 kg	30 kg	29 kg/56 kg
Max. power consumption	280 W/350 W	550 W	475 W/1.050 W
Tubes/plates capacity <sup>1)</sup>			
1.5/2.0 mL Eppendorf tubes	24	48	48
Eppendorf Tubes® 5.0 mL	10/-	12	16
8-place PCR strips	12/4	6	8
15 mL conical	-	-	6
50 mL conical	-	-	6
2.6 – 7 mL (13 mm)	-	-	12
3 – 15 mL (16 mm)	-	-	12
7 – 17 mL (17.5 mm)	-	-	12
MTP/PCR-plates	-	-	2
Deepwell plates (DWP)	-	-	2

For more information go to [www.eppendorf.com/centrifugation](http://www.eppendorf.com/centrifugation)

Technical specifications subject to change.

**epServices**  
for premium performance

On page 368 you will find detailed information on services for these products!

Your local distributor: [www.eppendorf.com/contact](http://www.eppendorf.com/contact)  
Eppendorf AG · Barkhausenweg 1 · 22339 Hamburg · Germany · [eppendorf@eppendorf.com](mailto:eppendorf@eppendorf.com) · [www.eppendorf.com](http://www.eppendorf.com)



Model	5702/5702 R/5702 RH	5804/5804 R
<b>Positioning</b>	Low speed centrifuge optimized for medium capacity needs in clinical research and cell culture labs	Compact high speed centrifuge for medium capacity needs
<b>Page(s)</b>	142	148
<b>Max. capacity</b>	4 x 100 mL	4 x 250 mL/2 x 5 MTP
<b>Max. RCF</b>	3,000 x g	20,913 x g
<b>Max. speed</b>	4,400 rpm	14,000 rpm
<b>Temperature control range</b>	- /-9 °C to 40 °C/-9 °C to 42 °C	- /-9 °C to 40 °C
<b>Dimensions (W x D x H)</b>	32 x 40 x 24 cm/38 x 58 x 26 cm/38 x 58 x 26 cm	47 x 55 x 34 cm/64 x 55 x 34 cm
<b>Height (with open lid)</b>	53 cm/60 cm/60 cm	74 cm
<b>Footprint (dimensions w/o front panel, WxD)</b>		47 x 50 cm/64 x 50 cm
<b>Weight w/o accessories</b>	20 kg/36 kg/36 kg	55 kg/80 kg
<b>Max. power consumption</b>	200 W/380 W/380 W	900 W/1,650 W
<b>Tubes/plates capacity <sup>1</sup></b>		
<b>1.5/2.0 mL Eppendorf tubes</b>	24 (F)/16 (S)	104
<b>Eppendorf Tubes® 5.0 mL</b>	4	20 (F)/32 (S)
<b>8-place PCR strips</b>	-	6
<b>15 mL conical</b>	20 (F)/8 (S)	40 (F)/32 (S)
<b>50 mL conical</b>	4 (S)	6 (F)/16 (S)
<b>2.6 – 7 mL (13 mm)</b>	36	6 (F)/56 (S)
<b>3 – 15 mL (16 mm)</b>	30	6 (F)/52 (S)
<b>7 – 17 mL (17.5 mm)</b>	24	6 (F)/48 (S)
<b>180 – 250 mL bottle</b>	-	4
<b>500 mL Corning®</b>	-	-
<b>750 mL bottle</b>	-	-
<b>1.000 mL bottle</b>	-	-
<b>MTP/PCR-plates</b>	-	10
<b>Deepwell plates (DWP)</b>	-	4

<sup>1</sup>F = Fixed-angle rotor, S = Swing-bucket rotor

For more information go to [www.eppendorf.com/centrifugation](http://www.eppendorf.com/centrifugation)

Technical specifications subject to change.



Model	5810/5810 R	5910 R	5920 R
<b>Positioning</b>	The workhorse for medium to high-throughput	The workhorse for medium to high throughput; high performance	The workhorse for high to very high-throughput laboratories: Highly versatile, high speed and high capacity
<b>Page(s)</b>	148	176	178
<b>Max. capacity</b>	4 x 750 mL/4 x 4 MTP	4 x 750 mL/4 x 5 MTP	4 x 1,000 mL/4 x 7 MTP
<b>Max. RCF</b>	20,913 x g	22,132 x g	21,194 x g
<b>Max. speed</b>	14,000 rpm	14,000 rpm	13,700 rpm
<b>Temperature control range</b>	- /-9 °C to 40 °C	-11 °C to 40 °C	-11 °C to 40 °C
<b>Dimensions (W x D x H)</b>	54 x 61 x 35 cm/70 x 61 x 35 cm	72 x 66 x 37 cm	74 x 71 x 40 cm
<b>Height (with open lid)</b>	80 cm	85 cm	94 cm
<b>Footprint (dimensions w/o front panel, WxD)</b>	54 x 54 cm/70 x 54 cm	72 x 62 cm	74 x 67 cm
<b>Weight w/o accessories</b>	68 kg/99 kg	109 kg	139 kg
<b>Max. power consumption</b>	900 W/1,650 W	1,650 W	1,650 W
<b>Tubes/plates capacity <sup>1</sup></b>			
<b>1.5/2.0 mL Eppendorf tubes</b>	200	48 (F)/200 (S)	48 (F)/368 (S)
<b>Eppendorf Tubes® 5.0 mL</b>	20 (F)/56 (S)	20 (F)/64 (S)	20 (F)/108 (S)
<b>8-place PCR strips</b>	6		
<b>15 mL conical</b>	40 (F)/56 (S)	40 (F)/64 (S)	6 (F)/108 (S)
<b>50 mL conical</b>	6 (F)/28 (S)	6 (F)/36 (S)	6 (F)/52 (S)
<b>2.6 – 7 mL (13 mm)</b>	6 (F)/100 (S)	6 (F)/120 (S)	6 (F)/196 (S)
<b>3 – 15 mL (16 mm)</b>	6 (F)/80 (S)	6 (F)/104 (S)	6 (F)/144 (S)
<b>7 – 17 mL (17.5 mm)</b>	6 (F)/80 (S)	6 (F)/84 (S)	6 (F)/80 (S)
<b>180 – 250 mL bottle</b>	4	6 (F)/4 (S)	6 (F)/8 (S)
<b>500 mL Corning®</b>	4	4	4
<b>750 mL bottle</b>	4	4	4
<b>1.000 mL bottle</b>	-		4
<b>MTP/PCR-plates</b>	16	20	28
<b>Deepwell plates (DWP)</b>	4	4	8

**epServices**  
for premium performance

On page 368 you will find detailed information on services for these products!

Your local distributor: [www.eppendorf.com/contact](http://www.eppendorf.com/contact)  
Eppendorf AG · Barkhausenweg 1 · 22339 Hamburg · Germany · [eppendorf@eppendorf.com](mailto:eppendorf@eppendorf.com) · [www.eppendorf.com](http://www.eppendorf.com)

## MiniSpin®/MiniSpin® plus

### Description

Powerful and user-friendly MiniSpin and MiniSpin plus are small enough so that each workstation can be equipped with a „personal“ centrifuge. Two models are available to meet your performance requirements. MiniSpin plus provides speed sufficient for molecular biology separations.



### Product features

- > Rotor capacity: 12 × 1.5/2.0 mL vessels, 2 × PCR strip
- > Max. speed: 14,100 × g (14,500 rpm)
- > Extremely compact footprint
- > Acceleration and deceleration time < 13 s
- > User-friendly digital display for time and speed
- > Metal rotor bowl
- > Separate short-spin key for fast and comfortable centrifugation
- > Optimal ventilation flow reduces heating and protects temperature-sensitive samples
- > Soft-touch lid closure for ergonomic lid locking
- > Automatic lid opening at the end of the run to prevent sample warming and to allow easy access to samples

### Special features for MiniSpin plus

- > Automatic rpm/rcf conversion
- > Extended time to 99 min or continuous centrifugation

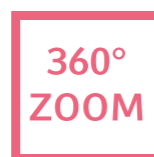

[www.eppendorf.com/minispin-360](http://www.eppendorf.com/minispin-360)



[www.eppendorf.com/minispin-brochure](http://www.eppendorf.com/minispin-brochure)



### Ordering information

Description	Order no.
Centrifuge MiniSpin®, with Rotor F-45-12-11, 230 V/50 – 60 Hz	5452 000.010
Centrifuge MiniSpin® plus, with Rotor F-45-12-11, 230 V/50 – 60 Hz	5453 000.015
Rotor F-55-16-5-PCR	5452 727.007
Rotor F-45-12-11	5452 720.008
Adapter, for 1 tube 0.5 mL, max. Ø 8 mm or microtainer 0.6 mL, max. Ø 8 mm, for all 1.5/2.0 mL rotors, set of 6 pcs.	5425 716.001
Adapter, for 1 PCR tube 0.2 mL, max. Ø 6 mm, for all 1.5/2.0 mL rotors, set of 6 pcs.	5425 715.005
Adapter, for 1 tube 0.4 mL, max. Ø 6 mm, for all 1.5/2.0 mL rotors, set of 6 pcs.	5425 717.008

✎ Ordering information for other voltage options begins on page 434

## Centrifuge 5418 R

### Description

The refrigerated Centrifuge 5418 R with its 18-place capacity rotor is specifically designed for low to medium capacity in 1.5/2.0 mL tubes and Microtainer®. Its speed of up to 16,873 × g allows for standard molecular biology applications. Moreover, this compact device has an especially low access height and is characterized by a remarkably quiet operation.



### Product features

- > Max. rotor capacity: 18 × 1.5/2.0 mL vessels
- > Max. speed: 16,873 × g (14,000 rpm)
- > Small footprint and low access height of 23 cm
- > OptiBowl® design for quiet operation – even without a rotor lid
- > Eppendorf QuickLock® rotor allows for fast and ergonomic lid locking
- > Soft-touch one-finger lid closure for ergonomic operation
- > Temperature range from 0 °C to +40 °C
- > Guaranteed temperature of 4 °C at maximum rotational speed
- > FastTemp function for quick pre-cooling and maximum temperature accuracy inside the rotor
- > ECO power shut-off engages after 8 hours of nonuse to reduce energy consumption (46 % over night) and extend compressor life (can be deactivated)



[www.eppendorf.com/centrifuge5418-brochure](http://www.eppendorf.com/centrifuge5418-brochure)



[www.eppendorf.com/centrifuge5418-360](http://www.eppendorf.com/centrifuge5418-360)



### Ordering information

Description	Order no.
Centrifuge 5418 R, refrigerated, with Rotor FA-45-18-11 and rotor lid, 230 V/50 – 60 Hz	5401 000.010
Adapter, for 1 tube 0.5 mL, max. Ø 8 mm or microtainer 0.6 mL, max. Ø 8 mm, for all 1.5/2.0 mL rotors, set of 6 pcs.	5425 716.001
Adapter, for 1 tube 0.4 mL, max. Ø 6 mm, for all 1.5/2.0 mL rotors, set of 6 pcs.	5425 717.008
Adapter, for 1 PCR tube 0.2 mL, max. Ø 6 mm, for all 1.5/2.0 mL rotors, set of 6 pcs.	5425 715.005

✎ Ordering information for other voltage options begins on page 434



# Centrifuge 5424 R

## Description

Refrigerated Centrifuge 5424 R is the laboratory standard when it comes to efficient cooling performance (e.g. quick cooling down from room temperature to set temperature) in a very ergonomic product design. It features state of the art cooling technology to ensure high temperature accuracy for maximum sample protection and best separation results. Ideal for everyday laboratory use.

### Product features

- > Max. rotor capacity: 24 × 1.5/2.0 mL vessels
- > Max. speed: 20,238 × g (14,680 rpm)
- > OptiBowl® design for quiet operation, even without a rotor lid
- > Soft-touch one-finger lid closure for ergonomic operation
- > Temperature range from -10 °C to +40 °C
- > ECO power shut-off engages after 8 hours of non-use to reduce energy consumption (40 % over night) and extend compressor life (can be deactivated)
- > FastTemp function for quick pre-cooling of the centrifuge, e.g. from ~ 21 °C to 4 °C in only 8 minutes
- > Guaranteed temperature of 4 °C at maximum rotational speed
- > Built-in condensation drain to eliminate water accumulation in the rotor chamber
- > The patented compressor technology reduces vibrations and protects your samples



[www.eppendorf.com/centrifuge5424-brochure](http://www.eppendorf.com/centrifuge5424-brochure)

### Ordering information

Description	Order no.
Centrifuge 5424 R, refrigerated, without rotor, keypad, 230 V/50 – 60 Hz	5404 000.210
Centrifuge 5424 R, refrigerated, with Rotor FA-45-24-11, rotary knobs, 230 V/50 – 60 Hz	5404 000.410
Centrifuge 5424 R, refrigerated, without rotor, rotary knobs, 230 V/50 – 60 Hz	5404 000.610
Centrifuge 5424 R, refrigerated, with Rotor FA-45-24-11, keypad, 230 V/50 – 60 Hz	5404 000.010

✎ Ordering information for other voltage options begins on page 434

# NEW - Centrifuge 5425

## Description

Centrifuge 5425 is the new laboratory standard with its 24-place capacity and speed up to 21,330 × g. Focusing on standard applications, it is an essential piece of equipment for modern labs ensuring optimal separation. The Centrifuge 5425 serves as a reliable partner especially for high-throughput users expecting a top level of ergonomic comfort and provides great flexibility with its 6 rotor options.



### Product features

- > Max. rotor capacity: 24 × 1.5/2.0 mL vessels, 10 × 5 mL
- > Max. speed: 21,330 × g (15,060 rpm)
- > New: Eppendorf QuickLock technology which allows for fast and ergonomic locking of the rotor lid
- > New: Increased software features (e.g. 10 acceleration and braking ramps, 3 program buttons, short function without continuous pressing of the key)
- > New: Increased rotor program (5.0 mL rotor, swing-bucket rotor for PCR strips)
- > OptiBowl® design for quiet operation, even without a rotor lid
- > Soft-touch one-finger lid closure for ergonomic operation
- > Low noise level (< 51 db) for quiet work environment
- > Automatic lid opening at the end of the run – prevents sample warming and allows easy access to samples
- > Certified aerosol-tight rotor comes standard for safe centrifugation of hazardous samples



[www.eppendorf.com/centrifuge5425-flyer](http://www.eppendorf.com/centrifuge5425-flyer)

### Ordering information

Description	Order no.
Centrifuge 5425, non-refrigerated, without rotor, keypad, 230 V/50 – 60 Hz	5405 000.310
Centrifuge 5425, non-refrigerated, without rotor, rotary knobs, 230 V/50 – 60 Hz	5405 000.719
Centrifuge 5425, non-refrigerated, with Rotor FA-24x2, keypad, 230 V/50 – 60 Hz	5405 000.115
Centrifuge 5425, non-refrigerated, with Rotor FA-24x2, rotary knobs, 230 V/50 – 60 Hz	5405 000.514

✎ Ordering information for other voltage options begins on page 434

ℹ For more information go to [www.eppendorf.com/centrifugation](http://www.eppendorf.com/centrifugation)

# Centrifuge 5427 R

## Description

The Centrifuge 5427 R was designed with high-throughput research applications in mind. With its aerosol-tight 48-place rotor it handles even the toughest challenges in a safe and reliable manner to provide you the efficiency boost you need. All aerosol-tight rotors, including the new rotors for Eppendorf Tubes® 5.0 mL as well as the 24 × 1.5/2.0 mL swing-bucket rotor are equipped with the Eppendorf QuickLock® lids for easy rotor lid opening and closing. Choose the Centrifuge 5427 R if a 24-place microcentrifuge (e.g. our Centrifuge 5424 R) doesn't meet your needs regarding tube capacity and if you don't need the extra versatility our cross-over Centrifuge 5430 R can offer you.

### Product features

- > Rotor capacity: 48 × 1.5/2.0 mL, 12 × 5.0 mL; Eppendorf QuickLock® rotor allows for fast and ergonomic lid locking
- > Max. speed: 25,000 × g (16,220 rpm)
- > High capacity 48-place rotor significantly increases productivity to save you valuable time
- > Whisper quiet operation due to optimized sound design
- > Soft touch one-finger closure for ergonomic operation
- > Temperature range from -10 °C to 40 °C
- > FastTemp function for quick pre-cooling of the centrifuge, e.g., from ~ 23 °C to 4 °C in only 11 minutes
- > ECO shut-off can be programmed to engage after 1, 2, 4 or 8 hours of non-use for maximum energy savings and extended compressor life
- > Built-in condensation drain to eliminate water accumulation
- > Automatic rotor recognition and imbalance detection for maximum operational safety



[www.eppendorf.com/centrifuge5427-video](http://www.eppendorf.com/centrifuge5427-video)

### Ordering information

Description	Order no.
Centrifuge 5427 R, refrigerated, rotary knobs, 230 V/50 – 60 Hz	5409 000.010
Centrifuge 5427 R, refrigerated, with Rotor FA-45-12-17, rotary knobs, 230 V/50 – 60 Hz	5409 000.630
Centrifuge 5427 R, refrigerated, with Rotor FA-45-30-11, rotary knobs, 230 V/50 – 60 Hz	5409 000.530
Centrifuge 5427 R, refrigerated, with Rotor FA-45-48-11, rotary knobs, 230 V/50 – 60 Hz	5409 000.210

⚡ Ordering information for other voltage options begins on page 434

ℹ For more information go to [www.eppendorf.com/centrifugation](http://www.eppendorf.com/centrifugation)

# Centrifuge 5430/5430 R

## Description

Unique cross-over Centrifuge 5430 and 5430 R combine the best features of a microcentrifuge (small footprint) and multipurpose centrifuge (versatility) in one instrument. These centrifuges spin rotors for Eppendorf tubes and PCR strips as you would expect from any microcentrifuge. But that's not all. In a compact size, Centrifuge 5430 and 5430 R also accommodate rotors for microplates and 15/50 mL conical tubes. The rotor program features Eppendorf QuickLock® rotors. This includes 48-place rotors (1.5/2.0 mL), a 16-place rotor for Eppendorf Tubes® 5.0 mL and a swing-bucket rotor (24 × 1.5/2.0 mL). With their unmatched versatility, Centrifuge 5430 and Centrifuge 5430 R are the flagship products among the Eppendorf microcentrifuge portfolio.

### Product features

- > Max. rotor capacity: 48 × 1.5/2.0 mL, 6 × 50 mL, 2 × MTP
- > Max. speed: 30,130 × g (17,500 rpm)
- > Remarkable versatility with 12 different rotors
- > Soft-touch one-finger lid closure for ergonomic operation
- > Menu-driven, multi lingual operation menu (English, German, French, Spanish) with large backlit display
- > 5 program keys for easy access to routine programs
- > Saves up to 50 user-defined programs
- > Automatic rotor recognition and imbalance detection for maximum operational safety
- > Eppendorf QuickLock® – System for quickly opening and closing the rotor lid

### Special features for Centrifuge 5430 R

- > Temperature range: -11 °C to +40 °C
- > The patented compressor technology reduces vibrations and protects your samples
- > Continuous cooling maintains a constant temperature after the run has been completed – your samples stay cool
- > FastTemp pro® function for programmable pre-cooling according to day and time
- > ECO shut-off engages after 8 hours of nonuse to reduce energy consumption (37 % overnight) and extend compressor life (can be deactivated in menu)
- > Built-in condensation drain to eliminate water accumulation



[qrcodecentrifuge5430-brochure](http://qrcodecentrifuge5430-brochure)

### Ordering information

Description	Order no.
Centrifuge 5430, non-refrigerated, with Rotor FA-45-30-11 incl. rotor lid, keypad, 230 V/50 – 60 Hz	5427 000.210
Centrifuge 5430, non-refrigerated, without rotor, keypad, 230 V/50 – 60 Hz	5427 000.015
Centrifuge 5430, non-refrigerated, with Rotor FA-45-30-11 incl. rotor lid, rotary knobs, 230 V/50 – 60 Hz	5427 000.415
Centrifuge 5430, non-refrigerated, without rotor, rotary knobs, 230 V/50 – 60 Hz	5427 000.610
Centrifuge 5430 R, refrigerated, without rotor, keypad, 230 V/50 – 60 Hz	5428 000.205
Centrifuge 5430 R, refrigerated, with Rotor FA-45-30-11 incl. rotor lid, keypad, 230 V/50 – 60 Hz	5428 000.010
Centrifuge 5430 R, refrigerated, with Rotor FA-45-30-11 incl. rotor lid, rotary knobs, 230 V/50 – 60 Hz	5428 000.410
Centrifuge 5430 R, refrigerated, without rotor, rotary knobs, 230 V/50 – 60 Hz	5428 000.610

⚡ Ordering information for other voltage options begins on page 434

## Technical Specification Microcentrifuges

Technical specifications				
Model	MiniSpin®	MiniSpin® plus	5418 R	5425
Max. RCF	12,000 × g	14,100 × g	16,873 × g	21,330 × g
Max. speed			14,000 rpm	15,060 rpm
Max. capacity	12 × 1.5/2.0 mL	12 × 1.5/2.0 mL	18 × 1.5/2.0 mL	10 × 5 mL
Rotors available	2	2	1	6
Acceleration time	13 s	13 s	11 s	15 s
Deceleration time	12 s	12 s	12 s	15 s
Timer	15 s – 30 min	15 s to 99 min, with continuous run function	30 s – 99 min, with continuous run function	10 s to 9:59 h, with continuous run function
SOFT brake function	no	no	no	10 ramps
Noise level	< 49 dB(A)	< 52 dB(A)	< 57 dB(A), with rotor lid: < 47 dB(A)	< 51 dB(A) with rotor FA-24x2
Max. power consumption	70 W	85 W	320 W	280 W
Dimensions (W × D × H)	22.6 × 23.9 × 12.0 cm	22.6 × 23.9 × 12.0 cm	30 × 46 × 25 cm	24 × 39 × 24 cm
Height (with open lid)	25 cm	25 cm	52 cm	48 cm
Weight w/o accessories	4.3 kg	4.3 kg	22 kg	15.6 kg
Cooling	non-refrigerated	non-refrigerated	refrigerated	non-refrigerated
Temperature control range	-	-	0 °C to +40 °C	-

Technical specifications				
Model	5424 R	5427 R	5430	5430 R
Max. RCF	21,130 × g	25,000 × g	30,130 × g	30,130 × g
Max. speed	15,000 rpm	16,220 rpm	17,500 rpm	17,500 rpm
Max. capacity	24 × 1.5/2.0 mL	48 × 1.5/2.0 mL	48 × 1.5/2.0 mL, 6 × 50 mL, 2 × MTP	48 × 1.5/2.0 mL, 6 × 50 mL, 2 × MTP
Rotors available	4	9	12	12
Acceleration time	15 s	18 s	14 s	14 s
Deceleration time	16 s	18 s	15 s	15 s
Timer	30 s to 9:59 h, with continuous run function	10 s to 9:59 h	30 s to 99:59 h, with continuous run function	30 s to 99:59 h, with continuous run function
SOFT brake function	yes	yes	yes	yes
Noise level	< 54 dB(A), with rotor lid: < 48 dB(A) with Rotor FA-45-24-11	< 46 dB(A) with Rotor F-45-48-11	< 58 dB(A) with Rotor F-45-30-11	< 54 dB(A) with Rotor F-45-30-11
Max. power consumption	350 W	550 W	475 W	1.050 W
Dimensions (W × D × H)	29 × 48 × 26 cm	31.9 × 54.0 × 25.4 cm	33 × 42 × 25 cm	38 × 64 × 29 cm
Height (with open lid)	51 cm		56 cm	63 cm
Weight w/o accessories	21 kg	30 kg	29 kg	56 kg
Cooling	refrigerated	refrigerated	non-refrigerated	refrigerated
Temperature control range	-10 °C to +40 °C	-11 °C to 40 °C	-	-11 °C to 40 °C

i For more information go to [www.eppendorf.com/centrifugation](http://www.eppendorf.com/centrifugation)

Technical specifications subject to change.

## Rotors MiniSpin/MiniSpin plus



**Rotor F-45-12-11**

> for 12 × 1,5/2.0 mL tubes



**Rotor F-55-16-5 PCR**

> for 2 × PCR strips

### Ordering information

Description	Order no.
Rotor F-45-12-11	5452 720.008
Rotor F-55-16-5-PCR	5452 727.007

## Rotors and Adapters for Centrifuge 5418/5418 R



**Rotor FA-45-18-11**

> for 18 × 1.5/2.0 mL tubes comes standard with unique Eppendorf QuickLock aerosol-tight lid for fast and reliable locking



**Adapter for 0.2 mL PCR Tubes**

> Ideal to spin down PCR Tubes after reaction setup. Adapter fits in any Eppendorf 1.5/2.0 mL rotor



**Adapter for 0.8 mL BD Microtainer® and 0.5 mL tubes**

> The adapter can be used with every Eppendorf rotor for 1.5/2.0 mL tubes

### Ordering information

Description	Order no.
Adapter, for 1 tube 0.5 mL, max. Ø 8 mm or microtainer 0.6 mL, max. Ø 8 mm, for all 1.5/2.0 mL rotors, set of 6 pcs.	5425 716.001
Adapter, for 1 tube 0.4 mL, max. Ø 6 mm, for all 1.5/2.0 mL rotors, set of 6 pcs.	5425 717.008
Adapter, for 1 PCR tube 0.2 mL, max. Ø 6 mm, for all 1.5/2.0 mL rotors, set of 6 pcs.	5425 715.005
Rotor FA-45-18-11, aerosol-tight*, 45° angle, 18 places, max. tube diameter 11 mm, incl. rotor lid (aluminum)	5418 707.005

## Rotors for Centrifuge 5424 R



### Rotor FA-45-24-11

- > Max. speed: 21,130 × g (15,000 rpm)
- > Max. capacity: 24 × 1.5/2.0 mL tubes
- > Aerosol-tight for safe centrifugation of hazardous samples



### Rotor FA-45-24-11-Special

- > Max. speed: 21,130 × g (15,000 rpm)
- > Max. capacity: 24 × 1.5/2.0 mL tubes
- > Aerosol-tight for safe centrifugation of hazardous samples
- > PTFE coating for increased chemical resistance



### Rotor F-45-18-11-Kit

- > Max. speed: 18,111 × g (15,000 rpm)
- > Max. capacity: 18 × spin columns or 1.5/2.0 mL tubes
- > Extended rim that protects tube caps from shearing off



### Rotor F-45-32-5-PCR

- > Max. speed: 18,615 × g (15,000 rpm)
- > Max. capacity: 4 × PCR strips

#### Ordering information

Description	Order no.
Rotor FA-45-24-11, aerosol-tight	5424 702.007
Rotor FA-45-24-11-Special, aerosol-tight	5424 700.004
Rotor F-45-18-11-Kit	5424 706.002
Rotor F-45-32-5-PCR	5424 704.000
Adapter, for 1 tube 0.5 mL, max. Ø 8 mm or microtainer 0.6 mL, max. Ø 8 mm, for all 1.5/2.0 mL rotors, set of 6 pcs.	5425 716.001
Adapter, for 1 tube 0.4 mL, max. Ø 6 mm, for all 1.5/2.0 mL rotors, set of 6 pcs.	5425 717.008
Adapter, for 1 PCR tube 0.2 mL, max. Ø 6 mm, for all 1.5/2.0 mL rotors, set of 6 pcs.	5425 715.005

## Rotors for Centrifuge 5425



### Rotors FA-24x2

- > Max. speed: 21,330 × g (15,060 rpm)
- > Max. capacity: 24 × 1.5/2.0 mL tubes
- > Aerosol-tight with Eppendorf QuickLock® lid



### Rotor F-24x2-PTFE

- > Max. speed: 21,330 × g (15,060 rpm)
- > Max. capacity: 24 × 1.5/2.0 mL tubes
- > Aerosol-tight with Eppendorf QuickLock
- > PTFE coating for increased chemical resistance



### Rotor FA-10x5

- > Max. speed: 21,330 × g (15,060 rpm)
- > Max capacity: 10 × Eppendorf Tubes® 5.0 mL
- > Aerosol-tight with Eppendorf QuickLock® lid



### Rotor FA-18x2 Kit

- > Max. speed: 18,565 × g (15,060 rpm)
- > Rotor with higher edge for safe centrifugation of up to 18 spin columns
- > Aerosol-tight with Eppendorf QuickLock® lid



### Rotor F-32x0.2-PCR

- > Max. speed: 18,134 × g (15,060 rpm)
- > for 4 × PCR strips or 32 × PCR tubes (0,2 mL)



### Rotor 96x0.2-PCR

- > Max. speed: 3,217 × g (6,000 rpm)
- > New swing bucket rotor
- > for 12 × 8 PCR strips 0.1/0.2 mL or 4 × 1/4 twin.tec PCR plate 96, unskirted divisible or 96 × PCR tubes with 0.2 mL

#### Ordering information

Description	Order no.
Rotor FA-24x2, aerosol-tight, for 24 × 1.5/2.0 mL tubes, incl. aerosol-tight rotor lid	5495 500.006
Rotor FA-24x2-PTFE, aerosol-tight, with PTFE coating, for 24 × 1.5/2.0 mL tubes, incl. aerosol-tight rotor lid	5495 503.005
Rotor FA-10x5, aerosol-tight, for 10 × 5.0 mL tubes (snap and screw cap), incl. aerosol-tight rotor lid	5495 505.008
Rotor FA-18x2-Kit, aerosol-tight, for 18 × 1.5/2.0 mL tubes or spin columns, incl. aerosol-tight rotor lid	5495 508.007
Rotor F-32x0.2-PCR, for 32 × 0.2 mL PCR tubes or 4 × 8 PCR strips, incl. rotor lid	5495 510.001
Rotor S-96x0.2-PCR, for 96 × 0.2 mL PCR tubes or 12 × 8 PCR strips, incl. buckets	5495 512.004
Adapter, for 1 vessel 1.5 – 2.0 mL, for Rotors FA-45-12-17, FA-45-16-17 and FA-45-20-17, set of 4 pcs.	5820 768.002
Adapter, for 1 cryo tube, for Rotors FA-45-12-17, FA-45-16-17 and FA-45-20-17, set of 4 pcs.	5820 769.009
Adapter, for 1 HPLC tube, for Rotors FA-45-12-17, FA-45-16-17 and FA-45-20-17, set of 4 pcs.	5820 770.007
Adapter, for 1 tube 0.5 mL, max. Ø 8 mm or microtainer 0.6 mL, max. Ø 8 mm, for all 1.5/2.0 mL rotors, set of 6 pcs.	5425 716.001
Adapter, for 1 tube 0.4 mL, max. Ø 6 mm, for all 1.5/2.0 mL rotors, set of 6 pcs.	5425 717.008
Adapter, for 1 PCR tube 0.2 mL, max. Ø 6 mm, for all 1.5/2.0 mL rotors, set of 6 pcs.	5425 715.005

## Rotors for Centrifuge 5427 R



### Rotor F-45-48-11

- > Max. speed: 18,210 × g (12,700 rpm)
- > Max. capacity: 48 × 1.5/2.0 mL tubes



### Rotor FA-45-48-11

- > Max. speed: 18,210 × g (12,700 rpm)
- > Max. capacity: 48 × 1.5/2.0 mL tubes
- > Aerosol-tight with Eppendorf QuickLock® lid



### Rotor FA-45-30-11

- > Max. speed: 20,800 × g (14,000 rpm)
- > Max. capacity: 30 × 1.5/2.0 mL tubes
- > Aerosol-tight with Eppendorf QuickLock® lid



### Rotor S-24-11-AT

- > Max. speed: 16,049 × g (12,700 rpm)
- > Swing-bucket rotor for 24 × 1.5/2.0 mL tubes
- > Aerosol-tight with Eppendorf QuickLock® lid
- > Perfect for phase-separation applications such as phenol-chloroform extraction



### Rotor FA-45-12-17

- > Max. speed: 20,600 × g (14,000 rpm)
- > Max capacity: 12 × Eppendorf Tubes® 5.0 mL
- > Aerosol-tight with Eppendorf QuickLock® lid



### Rotor F-45-48-5-PCR

- > Max. speed: 11,710 × g (10,500 rpm)
- > PCR strip rotor for up to 48 × 0.2 mL PCR tubes



### Rotor F-45-30-11

- > Max. speed: 20,800 × g (14,000 rpm)
- > Max. capacity: 30 × 1.5/2.0 mL tubes



### Rotor FA-45-24-11

- > Max. speed: 25,000 × g (16,220 rpm)
- > Max. capacity: 24 × 1.5/2.0 mL tubes
- > Aerosol-tight with Eppendorf QuickLock® lid



### Rotor FA-45-24-11-Kit

- > Max. speed: 19,100 × g (13,200 rpm)
- > Rotor with higher edge for safe centrifugation of up to 24 spin columns
- > Aerosol-tight with Eppendorf QuickLock® lid

#### Ordering information

Description	Order no.
Rotor FA-45-48-11, aerosol-tight, incl. rotor lid	5409 710.001
Rotor F-45-48-11, incl. rotor lid	5409 712.004
Rotor FA-45-30-11, aerosol-tight, incl. rotor lid	5409 706.004
Rotor F-45-30-11, incl. rotor lid	5409 708.007
Rotor FA-45-24-11, aerosol-tight, incl. rotor lid	5409 702.009
Rotor FA-45-24-11-Kit, aerosol-tight, incl. rotor lid	5409 704.001
Rotor S-24-11-AT, aerosol-tight, incl. wind shield and rotor lid	5409 715.003
Rotor F-45-48-5-PCR	5409 714.007
Rotor FA-45-12-17, aerosol-tight, incl. rotor lid, for 12 × Eppendorf Tubes® 5.0 mL	5409 700.006
Adapter, for 1 vessel 1.5 – 2.0 mL, for Rotors FA-45-12-17, FA-45-16-17 and FA-45-20-17, set of 4 pcs.	5820 768.002
Adapter, for 1 cryo tube, for Rotors FA-45-12-17, FA-45-16-17 and FA-45-20-17, set of 4 pcs.	5820 769.009
Adapter, for 1 HPLC tube, for Rotors FA-45-12-17, FA-45-16-17 and FA-45-20-17, set of 4 pcs.	5820 770.007
Adapter, for 1 tube 0.5 mL, max. Ø 8 mm or microtainer 0.6 mL, max. Ø 8 mm, for all 1.5/2.0 mL rotors, set of 6 pcs.	5425 716.001
Adapter, for 1 tube 0.4 mL, max. Ø 6 mm, for all 1.5/2.0 mL rotors, set of 6 pcs.	5425 717.008
Adapter, for 1 PCR tube 0.2 mL, max. Ø 6 mm, for all 1.5/2.0 mL rotors, set of 6 pcs.	5425 715.005

i For more information go to [www.eppendorf.com/centrifugation](http://www.eppendorf.com/centrifugation)

## Rotors for Centrifuge 5430/5430 R



### Rotor FA-45-48-11

- > Max. speed: 18,210 × g (12,700 rpm)
- > Max. capacity: 48 × 1.5/2.0 mL tubes
- > Aerosol-tight for safe centrifugation of hazardous samples
- > Eppendorf QuickLock® lid



### Rotor F-45-48-11

- > Max. speed: 18,210 × g (12,700 rpm)
- > Max. capacity: 48 × 1.5/2.0 mL tubes



### Rotor S-24-11-AT

- > Max. speed: 16,049 × g (12,700 rpm)
- > Swing-bucket rotor for 24 × 1.5/2.0 mL tubes
- > Aerosol-tight with Eppendorf QuickLock® lid
- > Perfect for phase-separation applications such as phenol-chloroform extraction



### Rotor F-45-30-11

- > Max. speed: 20,817 × g (14,000 rpm)
- > Max. capacity: 30 × 1.5/2.0 mL tubes
- > PTFE coating for increased chemical resistance



### Rotor FA-45-24-11-HS

- > Max. speed: 30,130 × g (17,500 rpm)
- > Max. capacity: 24 × 1.5/2.0 mL tubes
- > Extremely fast separation results
- > Aerosol-tight for safe centrifugation of hazardous samples
- > PTFE coating for increased chemical resistance



### Rotor F-35-6-30

- > Max. speed: 7,745 × g (7,830 rpm)
- > Rotor for 6 × 15/50 mL conical or 12 × Vacutainer® tubes



### Rotor FA-45-16-17

- > Max. speed: 21,191 × g (14,200 rpm)
- > Max. capacity: 16 × Eppendorf Tubes® 5.0 mL
- > Aerosol-tight for safe centrifugation of hazardous samples
- > Eppendorf QuickLock® lid
- > Eppendorf Tubes® 5.0 mL with screw caps only can use up half (8 ×) of the places in the rotor



### Rotor FA-45-30-11

- > Max. speed: 20,817 × g (14,000 rpm)
- > Max. capacity: 30 × 1.5/2.0 mL tubes
- > Aerosol-tight for safe centrifugation of hazardous samples
- > PTFE coating for increased chemical resistance
- > Eppendorf QuickLock® lid



### Rotor FA-45-24-11-Kit

- > Max. speed: 19,090 × g (13,200 rpm)
- > Rotor with higher edge for safe centrifugation of up to 24 spin columns
- > Aerosol-tight for safe centrifugation of hazardous samples
- > Eppendorf QuickLock® lid



### Rotor A-2-MTP

- > Max. speed: 2,204 × g (4,680 rpm)
- > 2-place swing-bucket rotor for MTP, PCR and Deepwell Plates
- > Windshield design for whisper quiet operation



### Rotor F-45-64-5-PCR

- > Max. speed: 13,543 × g (11,800 rpm)
- > PCR strip rotor for up to 64 × 0.2 mL PCR tubes



### Rotor F-45-18-17-Cryo

- > Max. speed: 8,324 × g (8,900 rpm)
- > 18-place rotor for Cryovials®

# Rotors for Centrifuge 5430/5430 R

## Ordering information

Description	Order no.
<b>Rotor FA-45-16-17</b> , aerosol-tight, incl. rotor lid, for 16 × Eppendorf Tubes® 5.0 mL	5427 750.002
<b>Rotor FA-45-48-11</b> , aerosol-tight, incl. rotor lid	5427 754.008
<b>Rotor F-45-48-11</b> , incl. rotor lid	5427 755.004
<b>Rotor S-24-11-AT</b> , aerosol-tight, incl. rotor lid	5427 757.007
<b>Rotor FA-45-30-11</b> , aerosol-tight, incl. rotor lid	5427 753.001
<b>Rotor FA-45-24-11-Kit</b> , aerosol-tight, incl. rotor lid	5427 752.005
<b>Rotor F-45-30-11</b> , incl. rotor lid	5427 712.003
<b>Rotor FA-45-24-11-HS</b> , aerosol-tight, incl. rotor lid	5427 710.000
<b>Rotor F-35-6-30</b> , incl. rotor lid, with 6 adapters for 15 mL/50 mL conical tubes	5427 716.009
<b>Rotor A-2-MTP</b> , incl. wind shield and rotor lid, with 2 buckets	5427 700.005
<b>Rotor F-45-64-5-PCR</b> , incl. rotor lid and adapters	5427 714.006
<b>Rotor F-45-18-17-Cryo</b> , incl. rotor lid and cryovial adapters	5427 705.007
<b>Adapter</b> , for 1 cryo containers (max. Ø 13 mm) or lidded centrifugation tubes (Ø 12.2 mm), max. length 50 mm, for Rotor F-45-18-17-Cryo, set of 6 pcs.	5702 752.002
<b>Adapter</b> , for 1 vessel 1.5 – 2.0 mL, for Rotors FA-45-12-17, FA-45-16-17 and FA-45-20-17, set of 4 pcs.	5820 768.002
<b>Adapter</b> , for 1 cryo tube, for Rotors FA-45-12-17, FA-45-16-17 and FA-45-20-17, set of 4 pcs.	5820 769.009
<b>Adapter</b> , for 1 HPLC tube, for Rotors FA-45-12-17, FA-45-16-17 and FA-45-20-17, set of 4 pcs.	5820 770.007
<b>Adapter</b> , for 1 tube 0.5 mL, max. Ø 8 mm or microtainer 0.6 mL, max. Ø 8 mm, for all 1.5/2.0 mL rotors, set of 6 pcs.	5425 716.001
<b>Adapter</b> , for 1 tube 0.4 mL, max. Ø 6 mm, for all 1.5/2.0 mL rotors, set of 6 pcs.	5425 717.008
<b>Adapter</b> , for 1 HPLC vessel 1.5 mL, for Rotor F-45-18-17-Cryo	5427 708.006
<b>Adapter</b> , for 1 PCR tube 0.2 mL, max. Ø 6 mm, for all 1.5/2.0 mL rotors, set of 6 pcs.	5425 715.005

## Adapter options 6 x 15/50 mL conical tube rotor

Adapter	Rotor capacity <sup>2)</sup>	Max. tube dimensions Ø x L	Max. RCF	For bore hole	Order no. <sup>4)</sup>
13 mm round	12	13 x 65 – 89 mm	6,443 x g	small	5427 740.007
			6,100 x g	large	5427 742.000
13 mm round	12	13 x 90 – 110 mm	7,471 x g	small	5427 741.003
			7,129 x g	large	5427 743.006
16 mm round	12	16 x 75 – 105 mm	7,005 x g	small	5427 732.004
		16 x 90 – 105 mm	7,005 x g	large	5427 734.007
17 mm round	12	17 x 90 – 125 mm	7,745 x g	small	5427 735.003
			7,403 x g	large	5427 738.002
Eppendorf Tubes® 5.0 mL	12	17.5 x 80 mm	6,237 x g	small	5427 746.005
		17.5 x 80 mm	7,129 x g	large	5427 747.001
15 mL conical	6	17.5 x 100 – 125 mm	7,540 x g	small	5427 726.004
30 mL round	6	26 x 92 – 112 mm	7,087 x g	large	5427 736.000
50 mL round	6	29 x 95 – 125 mm	7,581 x g	large	5427 737.006
50 mL conical	6 <sup>1) 2)</sup>	29.5 x 100 – 125 mm	7,197 x g	large	5427 727.000
Centriprep®	6	29.5 x 100 – 125 mm	7,567 x g	large	5427 723.005

<sup>1)</sup> Three set of 2 included within 6 x 15/50 mL rotor package. <sup>2)</sup> Adapter accommodates skirted 50 mL conical tubes. <sup>3)</sup> Please perform a manual test to determine the actual loading capacity. <sup>4)</sup> Set of 2



# Centrifuge 5702/5702 R/5702 RH

## Description

The 5702 family of low speed, general purpose centrifuges was especially designed to meet the requirement of low- to mid-throughput clinical research and cell culture labs. They are compact in design so that one can fit comfortably on every lab bench, quiet in operation to benefit your work environment, and provide 6 different rotor options to accommodate any type of tube.

### The right model for your application:

- > Centrifuge 5702 for standard applications
- > Refrigerated Centrifuge 5702 R for heat sensitive samples
- > Heated and refrigerated Centrifuge 5702 RH allows centrifugation under biological conditions to improve cell viability for more accurate results in downstream applications (e.g. cell cultivation)

### Product features

- > Max. speed: 3,000 × g (4,400 rpm)
- > Very compact footprint to fit on every lab bench
- > Very quiet operation to benefit your environment
- > Low access height for simple loading and unloading of samples
- > SOFT brake function for slow acceleration and braking. Optimized for cell separation by gradient centrifugation
- > "At set RPM" function starts the timer when the selected rotational speed is reached for reproducible centrifugation runs
- > Key lock to prevent unintentional adjustments
- > Stainless steel rotor chamber is rust-free and easy to clean
- > Electronic imbalance detection for maximum safety

### Special features for Centrifuge 5702 R and Centrifuge 5702 RH

- > Temperature settings from -9 °C to 40 °C
- > FastTemp function for fast precooling
- > Continuous cooling maintains a constant temperature after the run has been completed – your samples stay cool
- > ECO shut-off engages after 8 hours of non-use to reduce energy consumption and extend compressor life
- > Two program keys to store routine programs
- > Active heating guarantees high temperature accuracy during the entire centrifugation cycle (only 5702 RH)



[www.eppendorf.com/centrifuge5702-brochure](http://www.eppendorf.com/centrifuge5702-brochure)



[www.eppendorf.com/centrifuge5702-360](http://www.eppendorf.com/centrifuge5702-360)

For more information go to [www.eppendorf.com/centrifugation](http://www.eppendorf.com/centrifugation)

Technical specifications subject to change.



Centrifuge 5702 display



Centrifuge 5702 R and 5702 RH display

### Technical specifications

Model	5702	5702 R	5702 RH
Max. RCF	3,000 × g	3,000 × g	3,000 × g
Speed	100 – 4,400 rpm (100 rpm steps)	100 – 4,400 rpm (100 rpm steps)	100 – 4,400 rpm (100 rpm steps)
Max. capacity	4 × 100 mL	4 × 100 mL	4 × 100 mL
Rotors available	6	6	6
Acceleration time	25 s	25 s	25 s
Deceleration time	25 s	25 s	25 s
Timer	0 – 99 min, with continuous run function	0 – 99 min, with continuous run function	0 – 99 min, with continuous run function
SOFT brake function	yes	yes	yes
Noise level	< 52 dB(A) with Rotor A-4-38	< 46 dB(A) with Rotor A-4-38	< 46 dB(A) with Rotor A-4-38
Max. power consumption	200 W	380 W	380 W
Dimensions (W × D × H)	32 × 40 × 24 cm	38 × 58 × 26 cm	38 × 58 × 26 cm
Height (with open lid)	53 cm	60 cm	60 cm
Weight w/o accessories	20 kg	36 kg	36 kg
Cooling	non-refrigerated	refrigerated	refrigerated/heated
Temperature control range	–	-9 °C to 40 °C	-9 °C to 42 °C

### Ordering information

Description	Order no.
Centrifuge 5702, non-refrigerated, without rotor, rotary knobs, 230 V/50 – 60 Hz	5702 000.010
Centrifuge 5702, non-refrigerated, with Rotor A-4-38 incl. adapters for 15/50 mL conical tubes, rotary knobs, 230 V/50 – 60 Hz	5702 000.320
Centrifuge 5702 R, refrigerated, without rotor, rotary knobs, 230 V/50 – 60 Hz	5703 000.010
Centrifuge 5702 R, refrigerated, with Rotor A-4-38 incl. adapters for 15/50 mL conical tubes, 2 sets of 2 adapters, rotary knobs, 230 V/50 – 60 Hz	5703 000.425
Centrifuge 5702 R, refrigerated, with Rotor A-4-38 incl. adapters for 13/16 mm blood collection tubes, 2 sets of 2 adapters, rotary knobs, 230 V/50 – 60 Hz	5703 000.320
Centrifuge 5702 RH, refrigerated/heated, without rotor, rotary knobs, 230 V/50 – 60 Hz	5704 000.010

Ordering information for other voltage options begins on page 434



# Rotors for Centrifuge 5702/5702 R/5702 RH



## Rotor A-4-38 with round buckets

- > Maximum speed: 3,000 × g (4,400 rpm)
- > Standard rotor for centrifugation of blood collection tubes or 15/50 mL conical tubes
- > Round buckets for vessels with 1.5 – 100 mL
- > Wide variety of adapters for all blood collection tubes and cell culture tube types
- > Aerosol-tight<sup>1)</sup> caps for safe centrifugation of hazardous samples optionally available

<sup>1)</sup> Aerosol-tightness tested by Public Health England, Porton Down, UK.



## Ordering information

Description	Order no.
<b>Rotor A-4-38 with round buckets</b> , incl. 4 round buckets 100 mL	5702 720.003
<b>Round bucket 100 mL</b> , for Rotor A-4-38, set of 4	5702 722.006
<b>Aerosol-tight caps for 100 mL round buckets</b> , set of 2	5702 721.000

<b>Adapters for Rotor A-4-38 with round buckets</b>						
<b>Tube Volume</b>	1.5 – 2.0 mL	1.1 – 1.4 mL	2 – 7 mL	2.6 – 7 mL	4 – 10 mL	
<b>Max. tube diameter</b>	11 mm	8.5 mm	12.5 mm	13.5 mm	16 mm	
<b>Max. vessel height</b>	43 mm	100 mm	100 mm	100 mm	100 mm	
<b>Max. vessel height for use with cap/lid<sup>1)</sup></b>	43 mm	100 mm	100 mm	100 mm	100 mm	
<b>Adapter</b>						
<b>Number of vessels per adapter/rotor</b>	4/16	5/20	5/20	4/16	4/16	
<b>Bottom shape</b>	round	flat	flat	flat	flat	
<b>Centrifugation radius</b>	134 mm	132 mm	132 mm	132 mm	132 mm	
<b>Max. RCF</b>	2,900 × g	2,850 × g	2,850 × g	2,850 × g	2,850 × g	
<b>Packing</b>	set of 2 pcs.	set of 2 pcs.	set of 2 pcs.	set of 2 pcs.	set of 2 pcs.	
<b>Order no.</b>	5702 745.006	5702 736.007	5702 737.003	5702 719.005	5702 735.000	

<sup>1)</sup> Exceeding the maximum tube length may reduce the loading capacity of the rotor. Please perform a manual swing-out test before starting the centrifuge run to make sure the tubes do not hit the rotor yoke.

<b>Eppendorf Tubes® 5.0 mL</b>						
<b>17 mm</b>	9 – 15 mL	15 mL conical	15 mL conical	25 mL	50 mL conical	85/100 mL
<b>60 mm</b>	17.5 mm	17.2 mm	17.2 mm	25 mm	30 mm	38 mm
<b>60 mm</b>	100 mm	121 mm	121 mm	100 mm	115 mm	106 mm
<b>60 mm</b>	100 mm	120 mm		100 mm	115 mm	106 mm
<b>Adapter</b>						
<b>Number of vessels per adapter/rotor</b>	1/4	4/16	1/4	2/8	1/4	1/4
<b>Bottom shape</b>	flat	round	conical	conical	round	conical
<b>Centrifugation radius</b>	136 mm	130 mm	137 mm	137 mm	135 mm	135 mm
<b>Max. RCF</b>	2,943 × g	2,800 × g	3,000 × g	3,000 × g	2,900 × g	2,900 × g
<b>Packing</b>	set of 2 pcs.	set of 2 pcs.	set of 2 pcs.	set of 2 pcs.	set of 2 pcs.	set of 2 pcs.
<b>Order no.</b>	5702 733.008	5702 724.009	5702 732.001	5702 723.002	5702 717.002	5702 734.004
						5702 718.009













For more information go to [www.eppendorf.com/centrifugation](http://www.eppendorf.com/centrifugation)

# Rotors for Centrifuge 5702/5702 R/5702 RH

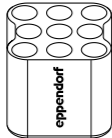

## Rotor A-4-38 with rectangular buckets

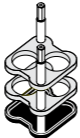
- > Maximum speed: 2,750 × g (4,400 rpm)
- > Rectangular buckets for vessels with 5 – 25 mL

						
<b>Adapters for Rotor A-4-38 with rectangular buckets</b>						
<b>Tube Volume</b>	round-bottom tubes	5 – 7 mL	9 mL	15 mL	25 mL	20 mL
<b>Max. tube diameter</b>	12 mm	13 mm	14.5 mm	17.5 mm	25 mm	22 mm
<b>Max. vessel height</b>	100 mm	100 mm	100 mm	100 mm	100 mm	100 mm
<b>Adapter</b>						
<b>Number of vessels per adapter/rotor</b>	9/36	10/40	8/32	6/24	2/8	4/16
<b>Bottom shape</b>	round	flat	flat	flat	flat	flat
<b>Centrifugation radius</b>	119 mm	127 mm	127 mm	127 mm	127 mm	127 mm
<b>Max. RCF</b>	2,577 × g	2,750 × g	2,750 × g	2,750 × g	2,750 × g	2,750 × g
<b>Packing</b>	set of 2 pcs.	set of 2 pcs.	set of 2 pcs.	set of 2 pcs.	set of 2 pcs.	set of 2 pcs.
<b>Order no.</b>	5702 763.004	5702 710.008	5702 711.004	5702 712.000	5702 716.006	5702 713.007

Ordering information	
Description	Order no.
Rotor A-4-38, without buckets	5702 740.004
Rectangular bucket 90 mL, for Rotor A-4-38, set of 4	5702 709.000



## Rotor A-8-17

- > Maximum speed: 2,800 × g (4,400 rpm)
- > Low capacity rotor for centrifugation of 15 mL conical tubes or 15 mL glass tubes
- > Adapters for 15 mL conical tubes and rubber mat inserts for glass tubes optionally available



## Rotor F-45-24-11

- > Maximum speed: 1,770 × g (4,400 rpm)
- > Fixed-angle rotor for 24 × 1.5/2.0 mL tubes
- > Quiet centrifugation even without rotor lid
- > Adapters optionally available for:
  - 0.2 mL PCR tubes (5425 715.005)
  - 0.4 mL centrifuge tubes (5425 717.008)
  - 0.5 mL micro test tubes and Microtainer® tubes (5425 716.001)
- > Rotor and adapters are autoclavable (121 °C, 20 min)



## Rotor F-35-30-17

- > Maximum speed: 2,750 × g (4,400 rpm)
- > High capacity rotor for 20 × 15 mL conical tubes or 30 × 15 mL glass tubes
- > Inserts for 15 mL conical tubes and rubber mats for use with glass tubes are included



## Rotor F-45-18-17-Cryo

- > Maximum speed: 1,840 × g (4,400 rpm)
- > Quiet centrifugation even without rotor lid
- > Centrifugation of 1 – 2 mL Cryo tubes® (max. 13 mm Ø, use with adapter) and tubes with screw cap (max. 17 mm Ø, no adapter required)
- > Rotor and adapters are autoclavable (121 °C, 20 min)

### Ordering information

Description	Order no.
Rotor A-8-17, 8 × 15 mL, without adapter, without rubber mats	5702 700.002
Rotor F-35-30-17, incl. 30 steel sleeves for 15 mL vessels, with 20 adapters for conical tubes and 30 rubber mats for round-bottom tubes	5702 704.008
Rotor F-35-30-17, incl. 10 steel sleeves for 15 mL vessels, with 10 adapters for conical tubes and 10 rubber mats for round-bottom tubes	5702 705.004
Rotor F-45-24-11, without lid	5702 746.002
Rotor F-45-18-17-Cryo, without rotor lid, without adapters	5702 747.009
Adapter, for 1 cryo containers (max. Ø 13 mm) or lidded centrifugation tubes (Ø 12.2 mm), max. length 50 mm, for Rotor F-45-18-17-Cryo, set of 6 pcs.	5702 752.002
Adapter, for 1 HPLC vessel 1.5 mL, for Rotor F-45-18-17-Cryo	5427 708.006

## Centrifuge 5804/5804 R and 5810/5810 R



### Description

Eppendorf Centrifuge 5804/5804 R and 5810/5810 R with their renowned quality and reliability offer you cost efficient solutions for your medium- to high-throughput applications – now and in the future. Centrifuge 5804/5804 R is a high speed centrifuge for medium capacity needs. It allows for molecular applications in tubes up to 250 mL and offers additional swing-bucket and fixed-angle rotors as well as deepwell plate capacity for increased versatility. Centrifuge 5810/5810 R is a workhorse for medium to high-throughput laboratories. It combines extraordinary versatility and capacity for both tubes and plates with an extraordinary compact footprint.



[www.eppendorf.com/centrifuge5810](http://www.eppendorf.com/centrifuge5810)

### Product features

- > Swing-bucket rotors and adapters accommodate tubes and bottles from 0.2 mL to 750 mL
- > Plate rotor for centrifugation of all types of MTP, PCR, cell culture, or Deepwell Plates
- > Fixed-angle rotors for high-speed applications in tubes from 0.2 mL to 85 mL
- > High centrifugation speed of up to 20,913 × g (14,000 rpm)
- > Aerosol-tight Eppendorf QuickLock® caps and lids for easy, one-hand operation
- > Centrifuge lid with soft-touch lid closure
- > Low access height of 29 cm for easy loading and unloading of samples
- > Quiet operation to improve your work environment
- > Compact footprint saves valuable bench space
- > Automatic rotor recognition and imbalance detection for maximum operational safety

### Additional features of refrigerated Centrifuge 5804 R and 5810 R

- > Temperature range from -9 °C to 40 °C
- > FastTemp function for fast pre-cooling
- > Continuous cooling maintains a constant temperature after the run has been completed – your samples stay cool
- > ECO shut-off engages after 8 hours of non-use to reduce energy consumption and to extend compressor life
- > Dynamic compressor control (DCC) technology for precise cooling performance

For more information go to [www.eppendorf.com/centrifugation](http://www.eppendorf.com/centrifugation)

## Centrifuge 5804/5804 R and 5810/5810 R

Technical specifications				
Model	5804	5804 R	5810	5810 R
Max. RCF with fixed-angle rotor	20,913 × g	20,913 × g	20,913 × g	20,913 × g
Max. RCF with swing-bucket rotor	4,500 × g	4,500 × g	4,500 × g	4,500 × g
Max. RCF with plate rotor	2,250 × g	2,250 × g	3,486 × g	3,486 × g
Speed	200 – 14,000 rpm (10 rpm steps)	200 – 14,000 rpm (10 rpm steps)	200 – 14,000 rpm (10 rpm steps)	200 – 14,000 rpm (10 rpm steps)
Max. capacity	4 × 250 mL/ 2 × 5 MTP	4 × 250 mL/ 2 × 5 MTP	4 × 750 mL/4 × 4 MTP	4 × 750 mL/4 × 4 MTP
Acceleration/braking ramps	10/10	10/10	10/10	10/10
Number of programs	35 user-defined programs	35 user-defined programs	35 user-defined programs	35 user-defined programs
Timer	1 min to 99 min, with continuous run function, short-spin	1 min to 99 min, with continuous run function, short-spin	1 min to 99 min, with continuous run function, short-spin	1 min to 99 min, with continuous run function, short-spin
Temperature range	–	-9 °C to 40 °C	–	-9 °C to 40 °C
Noise level				
Rotor S-4-104 (4×750 mL)	–	–	<59 dB(A)	<56 dB(A)
Rotor S-4-72 (4×250 mL)	<62 dB(A)	<58 dB(A)	–	–
Rotor FA-45-6-30 (6×50 mL)	<55 dB(A)	<54 dB(A)	<56 dB(A)	<55 dB(A)
Max. power consumption	900 W	1,650 W	900 W	1,650 W
Dimensions (W × D × H)	47 × 55 × 34 cm	64 × 55 × 34 cm	54 × 61 × 35 cm	70 × 61 × 35 cm
Footprint (dimensions w/o front panel, WxD)	47 × 50 cm	64 × 50 cm	54 × 54 cm	70 × 54 cm
Height (with open lid)	74 cm	74 cm	80 cm	80 cm
Weight w/o accessories	55 kg	80 kg	68 kg	99 kg

## Ordering information

Description	Order no.
Centrifuge 5804, non-refrigerated, without rotor, keypad, 230 V/50 – 60 Hz	5804 000.010
Centrifuge 5804 R, refrigerated, without rotor, keypad, 230 V/50 – 60 Hz	5805 000.010
Centrifuge 5810, non-refrigerated, without rotor, keypad, 230 V/50 – 60 Hz	5810 000.010
Centrifuge 5810 R, refrigerated, without rotor, keypad, 230 V/50 – 60 Hz	5811 000.015

✎ Ordering information for other voltage options begins on page 434



[www.eppendorf.com/centrifuge58xx-video](http://www.eppendorf.com/centrifuge58xx-video)

i For more information go to [www.eppendorf.com/centrifugation](http://www.eppendorf.com/centrifugation)

Technical specifications subject to change.

## Rolling Cabinet



## Description

If space is a limited resource in your lab, Eppendorf's rolling cabinet can give you the freedom and flexibility to use your Centrifuge 5804/5804 R or 5810/5810 R wherever you need it. Use the rolling cabinet if there is not enough space on the regular lab bench or to transport and use the centrifuge in other labs. The included drawer provides extra storage space for your rotors and adapters.



## Product features

- > Rolling cabinet with closed centrifuge fits under standard 90 cm lab benches
- > With 4 castors (2 lockable) and drawer
- > Dimensions (W × D × H): 70 × 62 × 45 cm



[www.eppendorf.com/cabinet-video](http://www.eppendorf.com/cabinet-video)



## Ordering information

Description	Order no.
Rolling Cabinet, for Centrifuge 5804/5804 R and 5810/5810 R	5821 020.010

Your local distributor: [www.eppendorf.com/contact](http://www.eppendorf.com/contact)  
Eppendorf AG · Barkhausenweg 1 · 22339 Hamburg · Germany · [eppendorf@eppendorf.com](mailto:eppendorf@eppendorf.com) · [www.eppendorf.com](http://www.eppendorf.com)

# Centrifuge Packages



## Description

Whether you need a refrigerated or non-refrigerated centrifuge for low, medium or high-throughput applications, one of these packages will definitely suit your requirements.

### Cell Culture Centrifuge packages include

- > Centrifuge 5702/5702R, 5804/5804 R or 5810/5810 R
- > Swing-bucket rotor incl. buckets
- > Four adapters for 15 mL conical tubes (two sets of 2)
- > Four adapters for 50 mL conical tubes (two sets of 2)

### Centrifuge packages for round-bottom tubes include

- > Centrifuge 5810/ 5810 R
- > Swing-bucket rotor S-4-104 incl. buckets
- > Four adapters for 13 mm (5/7 mL) round bottom tubes (two sets of 2)
- > Four adapters for 16 mm (10 mL) round bottom tubes (two sets of 2)

### Eppendorf Conical Tubes 15 mL and 50 mL

The Eppendorf Conical Tubes 15 mL and 50 mL are the optimal solution for sample preparation protocols in microbiology and molecular biology laboratories. Safe design and easy handling ensure best sample processing.

### Premium USP class 6 raw material ensures

- > highest sample integrity
- > high g-Safe® centrifugation stability
- > optimal sample and pellet visibility

For more information go to chapter „Reaction tubes and plates“ on page 108

Centrifuge Packages	Number of vessels per adapter/rotor	
	15 mL conical	50 mL conical
5702/5702 R	2/8	1/4
5804/5804 R + Rotor A-4-44	4/16	1/4
5804/5804 R + Rotor S-4-72	8/32	4/16
5810/5810 R + Rotor A-4-62	9/36	4/16
5810/5810 R + Rotor A-4-81	12/48	5/20
5810/5810 R + Rotor S-4-104	14/56	7/28
	13 mm	16 mm
5810/5810 R + S-4-104	23/92	20/80

## Ordering information

Description	Max. capacity of conical tubes per rotor	Order no.
Centrifuge 5702, non-refrigerated, with Rotor A-4-38 incl. adapters for 15/50 mL conical tubes, rotary knobs, 230 V/50 – 60 Hz	8 x 15 mL/4 x 50 mL	5702 000.320
Centrifuge 5702 R, refrigerated, with Rotor A-4-38 incl. adapters for 15/50 mL conical tubes, 2 sets of 2 adapters, rotary knobs, 230 V/50 – 60 Hz	8 x 15 mL/4 x 50 mL	5703 000.425
Centrifuge 5804, non-refrigerated, with Rotor A-4-44 incl. adapters for 15/50 mL conical tubes, keypad, 230 V/50 – 60 Hz	16 x 15 mL/4 x 50 mL	5804 000.320
Centrifuge 5804 R, refrigerated, with Rotor A-4-44 incl. adapters for 15/50 mL conical tubes, keypad, 230 V/50 – 60 Hz	16 x 15 mL/4 x 50 mL	5805 000.320
Centrifuge 5804, non-refrigerated, with Rotor S-4-72 incl. adapters for 15/50 mL conical tubes, keypad, 230 V/50 – 60 Hz	32 x 15 mL/16 x 50 mL	5804 000.520
Centrifuge 5804 R, refrigerated, with Rotor S-4-72 incl. adapters for 15/50 mL conical tubes, keypad, 230 V/50 – 60 Hz	32 x 15 mL/16 x 50 mL	5805 000.620
Centrifuge 5810, non-refrigerated, with Rotor A-4-62 incl. adapters for 15/50 mL conical tubes, keypad, 230 V/50 – 60 Hz	36 x 15 mL/16 x 50 mL	5810 000.320
Centrifuge 5810 R, refrigerated, with Rotor A-4-62 incl. adapters for 15/50 mL conical tubes, keypad, 230 V/50 – 60 Hz	36 x 15 mL/16 x 50 mL	5811 000.325
Centrifuge 5810, non-refrigerated, with Rotor A-4-81 incl. adapters for 15/50 mL conical tubes, keypad, 230 V/50 – 60 Hz	48 x 15 mL/20 x 50 mL	5810 000.420
Centrifuge 5810 R, refrigerated, with Rotor A-4-81 incl. adapters for 15/50 mL conical tubes, keypad, 230 V/50 – 60 Hz	48 x 15 mL/20 x 50 mL	5811 000.420
Centrifuge 5810, non-refrigerated, with Rotor S-4-104 incl. adapters for 15/50 mL conical tubes, keypad, 230 V/50 – 60 Hz	56 x 15 mL/28 x 50 mL	5810 000.525
Centrifuge 5810 R, refrigerated, with Rotor S-4-104 incl. adapters for 15/50 mL conical tubes, keypad, 230 V/50 – 60 Hz	56 x 15 mL/28 x 50 mL	5811 000.620

## Ordering information

Description	Max. capacity of round-bottom tubes per rotor	Order no.
Centrifuge 5810, non-refrigerated, with Rotor S-4-104 incl. adapters for 13/16 mm round-bottom tubes, keypad, 230 V/50 – 60 Hz	92 x 13 mm/80 x 16 mm	5810 000.620
Centrifuge 5810 R, refrigerated, with Rotor S-4-104 incl. adapters for 13/16 mm round-bottom tubes, keypad, 230 V/50 – 60 Hz	92 x 13 mm/80 x 16 mm	5811 000.820

✎ Ordering information for other voltage options begins on page 434

## Overview of Swing-Bucket Rotors 58xx Family



Model	Rotor S-4-104 4 x 750 mL	Rotor A-4-81 4 x 500 mL	Rotor A-4-62 4 x 250 mL
Max. capacity			
5804/5804 R	■	■	■
5810/5810 R	■	■	■
Positioning	High-capacity swing-bucket rotor for blood, bacteria, cell culture and plate centrifugation	Medium to high capacity swing-bucket rotor for blood, bacteria, cell culture and plate centrifugation	Economic swing-bucket rotor for blood, bacteria, cell culture and plate centrifugation
Aerosol-tightness tubes/plates	yes/yes	yes/no	yes/no
Max. RCF	3,214 x g	3,220 x g	3,220 x g
Max. speed	3,900 rpm	4,000 rpm	4,000 rpm
Eppendorf Tubes® 5.0 mL and 15 mL conical	56	48	36
50 mL conical	28	20/28 <sup>1)</sup>	16
13 mm blood tube	92	100	60
16 mm blood tube	80	64	48
1.5/2.0 mL micro tube	200	96	64
MTP	16	16	16
DWP	4	4	4

<sup>1)</sup> Maximum capacity with dedicated 50 mL bucket.



Model	Rotor S-4-72 4 x 250 mL	Rotor A-4-44 4 x 100 mL	Rotor A-2-DWP-AT 2 x 6 MTP	Rotor A-2-DWP 2 x 5 MTP
Max. capacity				
5804/5804 R	■	■	■	■
5810/5810 R	■	■	■	■
Positioning	Economic swing-bucket rotor for blood, bacteria, cell culture and plate centrifugation	High-speed swing-bucket rotor for platelet poor plasma, blood, bacteria and cell culture	Aerosol-tight deepwell plate rotor for safe centrifugation of hazardous samples.	Economic deepwell plate rotor
Aerosol-tightness tubes/plates	no/-	yes/-	-/yes	-/no
Max. RCF	3,234 x g	4,500 x g	3,486 x g	2,250 x g
Max. speed	4,200 rpm	5,000 rpm	4,500 rpm	3,700 rpm
Eppendorf Tubes® 5.0 mL and 15 mL conical	32	16		
50 mL conical	16	4/8 <sup>1)</sup>		
13 mm blood tube	56	36		
16 mm blood tube	52	28		
1.5/2.0 mL micro tube	104	48	48	48
MTP			12	10
DWP			4	4

## Advanced Rotor Design – Swing-Bucket Rotors



### Improved energy efficiency

The round buckets have been designed to be especially aerodynamic. The result is a more efficient design that reduces power consumption by up to 48 %.

### Longer rotor lifetime

The second rotor generation of both swing-bucket and fixed-angle rotors has been designed with a longer lifetime in mind.

### Product features

- > New Eppendorf QuickLock® caps for one-hand operation
- > Significantly improved handling, easy operation with one or two hands
- > Handle allows the closed bucket to be carried to the biosafety cabinet where it can be opened in a safe environment.
- > Aerosol-tightness has been tested and verified by Public Health England, Porton Down, UK



### Mixed bucket loading

Rotors S-4-104 and A-4-81 allow for mixed loading with 2 plate buckets and 2 round/rectangular buckets. This increases the versatility of the rotor. You can, for example, order the rotor with 4 rectangular/round buckets for tubes and, in addition, buy a set of 2 plate buckets. There is no need to buy a complete set of 4 plate buckets.



[www.eppendorf.com/rotors-video](http://www.eppendorf.com/rotors-video)

## Overview of the Main Fixed-Angle Rotors 58xx Family



Model	Rotor F-34-6-38 6 x 85 mL	Rotor FA-45-6-30 6 x 50 mL
Max. capacity		
5804/5804 R	■	■
5810/5810 R	■	■
Positioning	High-speed rotor suitable for molecular applications in tubes up to 85 mL	Aerosol-tight high-speed rotor for safe centrifugation of hazardous samples
Aerosol-tightness	no	yes
Max. RCF	18,500 x g	20,130 x g
Max. speed	12,000 rpm	12,100 rpm
1.5/2.0 mL micro tube	24	
Eppendorf Tubes® 5.0 mL and 15 mL conical	6	6
50 mL conical	6	6
85 mL	6	

Model	Rotor FA-45-20-17 20 x 5.0 mL	Rotor FA-45-48-11 48 x 1.5/2.0 mL	Rotor F-45-30-11/Rotor FA-45-30-11 30 x 1.5/2.0 mL
Max. capacity			
5804/5804 R	■	■	■
5810/5810 R	■	■	■
Positioning	Applications in Eppendorf Tube 5.0 mL	Aerosol-tight microcentrifuge tube rotor for safe centrifugation of hazardous samples	Micro centrifuge tube rotor
Aerosol-tightness	yes	yes	no/yes
Max. RCF	20,913 x g	19,083 x g	20,800 x g
Max. speed	13,100 rpm	13,000 rpm	14,000 rpm
1.5/2.0 mL micro tube	20	48	30
Eppendorf Tubes® 5.0 mL and 15 mL conical	20/-		
50 mL conical			
85 mL			

## Advanced Rotor Design – Fixed-Angle Rotors



### Low rotor weight

Eppendorf's fixed-angle rotors are among the lightest in the industry to improve handling and operational safety. Light-weight rotors cause less wear and tear on the motor and allow for faster acceleration and braking times.

### Eppendorf QuickLock® lids for ergonomic lid locking

Our aerosol-tight QuickLock rotors close with only ¼ of a turn. This not only saves you time during every day use, it also takes repetitive stress off your wrist.

### Superior temperature control

Aluminum, with its high heat conductivity, allows fast pre-cooling and accurate temperature control in refrigerated centrifuges.

### Product features

- > All rotors are anodized for high chemical resistance and to prevent corrosion
- > Optimized design of rotor boreholes and adapters provide optimal support for high-speed centrifugation of tubes
- > Aluminum rotors are recyclable



[www.eppendorf.com/rotors-video2](http://www.eppendorf.com/rotors-video2)

### Ordering information

Description	Order no.
Rotor FA-45-20-17, incl. rotor lid, for 20 x Eppendorf Tubes® 5.0 mL	5820 765.003
Adapter, for 1 vessel 1.5 – 2.0 mL, for Rotors FA-45-12-17, FA-45-16-17 and FA-45-20-17, set of 4 pcs.	5820 768.002
Adapter, for 1 cryo tube, for Rotors FA-45-12-17, FA-45-16-17 and FA-45-20-17, set of 4 pcs.	5820 769.009
Adapter, for 1 HPLC tube, for Rotors FA-45-12-17, FA-45-16-17 and FA-45-20-17, set of 4 pcs.	5820 770.007
Rotor FA-45-48-11, incl. rotor lid, for 48 x 1.5/2.0 mL tubes	5820 760.001
Rotor F-45-30-11, incl. rotor lid, for 30 x 1.5/2.0 mL reaction vessels	5804 715.004
Rotor FA-45-30-11, incl. rotor lid, for 30 x 1.5/2.0 mL reaction vessels, aerosol-tight	5804 726.006

# Rotors for 58xx Family



Model	Rotor F-35-48-17 <sup>1)</sup>	Rotor T-60-11	Rotor F-45-48-PCR
Max. capacity		60 x 1.5/2.0 mL	6 x 5/8 PCR strips (48 x 0.2 mL)
5804/5804 R	■	■	■
5810/5810 R	■	■	■
Aerosol-tightness	no	no	no
Max. RCF	5,005 x g	16,400 x g	15,350 x g
Max. speed	5,500 rpm	14,000 rpm	12,000 rpm
1.5/2.0 mL micro tube			
Eppendorf Tubes® 5.0 mL and 15 mL conical	-/40		

<sup>1)</sup> Please note that a software upgrade will be necessary for older centrifuges when using this rotor. Please contact your local Eppendorf organization or dealer for further information.

## Ordering information

Description	Order no.
Rotor F-35-48-17, for 24 x 15 mL conical tubes, incl. 24 steel sleeves and adapters	5820 771.003
Rotor F-35-48-17, for 40 x 15 mL conical tubes, incl. 48 steel sleeves and adapters	5820 772.000
Rotor T-60-11, incl. rotor lid, for 1.5/2.0 mL tubes, without adapter	5804 730.003
Adapter, for 10 reaction vessels 1.5/2.0 mL, for Rotor T-60-11, set of 6 pcs.	5804 731.000
Adapter, for 20 reaction vessels 0.4 mL, for Rotor T-60-11, set of 6 pcs.	5804 732.006
Rotor F-45-48-PCR, for 6 x 8, 6 x 5 PCR tube strips, 48 x 0.2 mL individual PCR tubes	5804 735.005



## Rotor A-2-DWP-AT

- > For use in Centrifuge 5810/5810 R only<sup>1)</sup>
- > Max. speed: 3,486 x g (4,500 rpm)
- > Rotor can handle up to 2 x 6 MTP, 2 x 2 DWP, 2 x 1 Filtration plate kits
- > Maximum loading height of 67 mm (89 mm without lid)
- > Rotor comes with aerosol-tight caps<sup>2)</sup> for safe centrifugation of hazardous samples
- > Rotor and buckets are autoclavable (121 °C, 20 min)

<sup>1)</sup> Please note that a software upgrade may be necessary for older centrifuges when using Rotor A-2-DWP-AT. Please contact your local Eppendorf organization or dealer for further information <sup>2)</sup> Aerosol-tightness tested by Public Health England, Porton Down, UK.

## Ordering information

Description	Order no.
Rotor A-2-DWP-AT, incl. 2 buckets, 2 aerosol-tight caps and 2 plate carriers	5820 710.004



## PCR adapter

- > PCR plate adapters are designed to support thin-walled PCR plate wells during centrifugation
- > Available for 96-well and 384-well PCR plates
- > Adapters can be used in all Eppendorf plate rotors

## Cell culture flask adapter

- > Adapter to spin down cell cultures directly in a cell culture flask
- > Suitable for 25 cm<sup>2</sup> and selective 75 cm<sup>2</sup> flasks (please ask for details)
- > Adapters can be used in Eppendorf plate rotor A-4-81-MTP/Flex

## IsoRack adapter

- > IsoRack adapters to support 0.5 mL and 1.5/2.0 mL IsoRacks during centrifugation
- > Adapters can be used in Eppendorf plate rotors A-2-DWP and A-4-81-MTP/Flex

## Ordering information

Description	Order no.
Adapter, for 1 cell culture flask, for Rotors A-4-81-MTP/Flex	5825 719.000
Adapter, for 1 PCR plate (96 wells) PCR plate 96 wells, for plate rotors, set of 2 pcs.	5825 711.009
Adapter, for 1 PCR plate (384 wells) PCR plate 384 wells, for plate rotors, set of 2 pcs.	5825 713.001
CombiSlide Adapter, for 12 slides Combi Slide 12 slides, for plate rotors, set of 2 pcs.	5825 706.005
Adapter, for 24 vessels in the IsoRack 0.5 mL, for Rotors S-4-104, A-4-81-MTP/Flex, A-2-DWP, set of 2 pcs.	5825 708.008
Adapter, for 24 vessels in the IsoRack 1.5/2.0 mL, for Rotors S-4-104, A-4-81-MTP/Flex, A-2-DWP, set of 2 pcs.	5825 709.004



## Rotor A-2-DWP

- > For use in Centrifuge 5804/5804 R and 5810/5810 R
- > Max. speed: 2,250 x g (3,700 rpm)
- > Rotor can handle up to, 2 x 5 MTP, 2 x 4 Cell culture plates, 2 x 2 DWP, 2 x 1 Filtration plate kits
- > Maximum loading height of 89 mm
- > Rotor and buckets are autoclavable (121 °C, 20 min)

## Ordering information

Description	Order no.
Rotor A-2-DWP, rotor for Deepwell Plates incl. 2 buckets	5804 740.009



## Rotors for 58xx Family

**Rotor S-4-104**

- > High capacity swing-bucket rotor with max. speed  $3,214 \times g$  (3,900 rpm)<sup>1)</sup>
- > Broad range of adapters enables high versatility for tubes and bottles from 0.2 mL to 750 mL and plates
- > Aerodynamic round bucket design for up to 36 % energy savings compared to Rotor A-4-81
- > Mixed loading with 2 plate buckets and 2 round tube buckets allows for increased versatility
- > Aerosol-tight QuickLock caps for safe centrifugation of hazardous samples optionally available<sup>2)</sup>
- > Buckets, lids and adapters are autoclavable (121 °C, 20 min)

<sup>1)</sup> Please note that a software upgrade will be necessary for older centrifuges when using this rotor. Please contact your local Eppendorf organization or dealer for further information. <sup>2)</sup> Aerosol-tightness tested by Public Health England, Porton Down, UK.

<b>Adapters for Rotor S-4-104</b>						
<b>Tube Volume</b>	1.5/2.0 mL	12 x 75 mm, 5 mL FACS	2.6 – 8 mL	5.5 – 12 mL	9 mL	14 mL
<b>Max. tube diameter</b>	11 mm	12 mm	13 mm	16 mm	17.5 mm	17.5 mm
<b>Max. vessel height</b>	39 mm	111 mm	115 mm	119 mm	111 mm	117 mm
<b>Max. vessel height for use with cap/lid<sup>1)</sup></b>	39 mm	100 mm	108 mm	114 mm	106 mm	112 mm
<b>Adapter</b>						
<b>Number of vessels per adapter/rotor</b>	50/200	27/108	23/92	20/80	20/80	14/56
<b>Bottom shape</b>	flat	round	round	round	round	round
<b>Centrifugation radius</b>	188 mm	175 mm	179 mm	180 mm	179 mm	185 mm
<b>Max. RCF</b>	$3,197 \times g$	$2,976 \times g$	$3,044 \times g$	$3,061 \times g$	$3,044 \times g$	$3,146 \times g$
<b>Packing</b>	set of 2 pcs.	set of 2 pcs.	set of 2 pcs.	set of 2 pcs.	set of 2 pcs.	set of 2 pcs.
<b>Order no.</b>	5825 740.009	5825 747.003	5825 738.004	5825 736.001	5825 743.008	5825 748.000

<sup>1)</sup> Exceeding the maximum tube length may reduce the loading capacity of the rotor. Please perform a manual swing-out test before starting the centrifuge run to make sure the tubes do not hit the rotor yoke.  
<sup>2)</sup> Please note that these conical bottles need to be used together with a conical form insert provided by the manufacturer. <sup>3)</sup> 225 mL conical for S-4-104 and S-4x750, 250 mL conical and Nunc 250 mL for S-4x1000 with round bucket.

**Ordering information**

Description	Order no.
<b>Rotor S-4-104</b>	
incl. 4 x 750 mL round buckets	5820 740.000
incl. 4 plate buckets (aerosol-tight capable)	5820 754.001
without buckets	5820 755.008
<b>Plate bucket (aerosol-tight capable)</b> , for Rotor S-4-104, incl. plate carrier, set of 2 pcs.	5820 744.006
<b>Plate bucket (aerosol-tight capable)</b> , for Rotor S-4-104, incl. plate carrier, set of 4 pcs.	5820 743.000
<b>Bucket 750 mL</b> , for Rotor S-4-104, set of 2 pcs.	5820 742.003
<b>Bucket 750 mL</b> , for Rotor S-4-104, set of 4 pcs.	5820 741.007
<b>Aerosol-tight caps for plate buckets (aerosol-tight capable)</b> , aerosol-tight, for Rotor S-4-104 and Rotor S-4x750, set of 2 pcs.	5820 748.001
<b>Aerosol-tight caps for 750 mL round buckets</b> , aerosol-tight, for Rotor S-4-104, Rotor S-4x750 and Rotor S-4x1000, set of 2 pcs.	5820 747.005
<b>Wide-neck bottle</b> , 750 mL, set of 2 pcs.	5820 708.000

Eppendorf Tubes® 5.0 mL and 15 mL conical	30 mL	50 mL conical	50 mL conical, skirted	250 mL flat, 175 – 225/ 250 mL conical <sup>2) 3)</sup>	500 mL Corning®	750 mL	MTP, DWP, PCR plates
17 mm	25 mm	31 mm	31 mm	62 mm	98 mm	104 mm	
125 mm	111 mm	122 mm	120 mm	145 mm	150 mm	140 mm	60 mm
120 mm	106 mm	116 mm	116 mm	125 mm			45 mm
14/56	8/32	7/28	5/20	1/4	1/4	1/4	4/16 (MTP) 1/4 (DWP)
conical	flat	conical	conical	flat	conical	flat	flat
188 mm	174 mm	187 mm	178 mm	183 mm	187 mm	185 mm	151 mm
$3,197 \times g$	$2,958 \times g$	$3,180 \times g$	$3,027 \times g$	$3,112 \times g$	$3,146 \times g$	$3,146 \times g$	$2,568 \times g$
set of 2 pcs.	set of 2 pcs.	set of 2 pcs.	set of 2 pcs.	set of 2 pcs.	set of 2 pcs.	set of 2 pcs.	set of 2 pcs.
5825 734.009	5825 755.006	5825 733.002	5825 732.006	5825 741.005	5825 745.000	5825 744.004	5820 744.006





# Rotors for 58xx Family

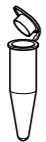
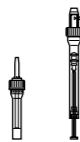
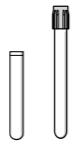

## Rotor A-4-81

- > Swing-bucket rotor with max. speed 3,220 × g (4,000 rpm)
- > Rotor A-4-81 accommodates tubes and bottles from 0.2 mL to 500 mL as well as plates
- > Aerosol-tight caps<sup>1)</sup> for safe centrifugation of hazardous samples optionally available
- > Mixed loading with 2 plate buckets and 2 rectangular tube buckets allows for increased versatility
- > Buckets, caps and adapters are autoclavable (121 °C, 20 min)

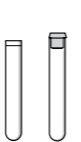
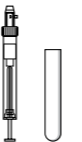
<sup>1)</sup> Aerosol-tightness tested by Public Health England, Porton Down, UK.

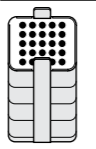
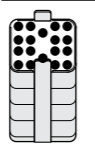
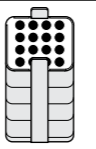
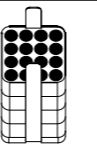





						
<b>Adapters for Rotor A-4-81</b>						
<b>Tube Volume</b>	1.5/2.0 mL	1.2 – 5 mL	2.6 – 5 mL	2.6 – 7 mL	3 – 15 mL	7 – 17 mL
<b>Max. tube diameter</b>	11 mm	11 mm	13 mm	13 mm	16 mm	17.5 mm
<b>Max. vessel height</b>	43 mm	118 mm	118 mm	118 mm	118 mm	118 mm
<b>Max. vessel height for use with cap/lid<sup>1)</sup></b>	43 mm	108 mm	107 mm	108 mm	108 mm	118 mm
<b>Adapter</b>						
<b>Number of vessels per adapter/rotor</b>	20/80	20/80	25/100	18/72	16/64	16/64
<b>Bottom shape</b>	flat	flat	flat with rubber mat	flat with rubber mat	flat with rubber mat	flat with rubber mat
<b>Centrifugation radius</b>	165 mm	168 mm	168 mm	168 mm	168 mm	168 mm
<b>Max. RCF</b>	2,950 × g	3,000 × g	3,000 × g	3,000 × g	3,000 × g	3,000 × g
<b>Packing</b>	set of 2 pcs.	set of 2 pcs.	set of 2 pcs.	set of 2 pcs.	set of 2 pcs.	set of 2 pcs.
<b>Order no.</b>	5810 745.004	5810 746.000	5810 720.001	5810 747.007	5810 748.003	5810 721.008

<sup>1)</sup> Exceeding the maximum tube length may reduce the loading capacity of the rotor. Please perform a manual swing-out test before starting the centrifuge run to make sure the tubes do not hit the rotor yoke.

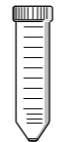
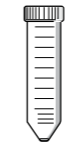
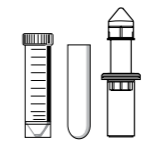
<sup>2)</sup> Please order adapter for 50 mL conical tubes skirted 5804 737.008.<sup>3)</sup> Please note that these conical bottles need to be used together with a conical form insert provided by the manufacturer.

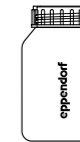
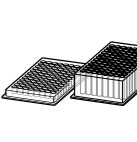
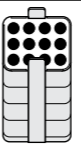
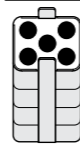
## Ordering information

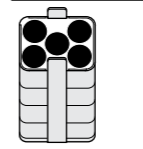
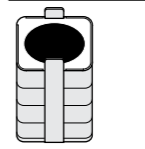
Description	Order no.
<b>Rotor A-4-81</b> , incl. 4 x 500 mL rectangular buckets	5810 718.007
<b>Rotor A-4-81</b> , without buckets	5810 743.001
<b>Rotor A-4-81</b> , with 4 MTP/Flex buckets	5810 725.003
<b>Bucket 500 mL rectangular</b> , for Rotor A-4-81, set of 4 pcs.	5810 730.007
<b>Bucket for 7 x 50 mL conical tubes</b> , for Rotor A-4-81, set of 4 pcs.	5825 730.003
<b>Cap for 500 mL rectangular buckets</b> , aerosol-tight, aerosol-tight, for Rotor A-4-81, set of 2 pcs.	5810 724.007
<b>Wide-neck bottle</b> , for Rotor A-4-81, 500 mL, square, set of 2 pcs.	5820 707.003
<b>Wide-neck bottle</b> , for Rotor A-4-81, 400 mL, set of 2 pcs.	5810 729.009
<b>MTP/Flex bucket</b> , for Rotor A-4-81, set of 2 pcs.	5810 742.005
<b>MTP/Flex bucket</b> , for Rotor A-4-81, set of 4 pcs.	5810 741.009

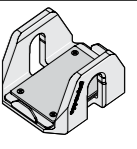
								
<b>Eppendorf Tubes® 5.0 mL and 15 mL conical tubes</b>								
<b>17.5 mm</b>	31 mm	31 mm	31/29 mm	62 mm	81 mm	83 mm		
<b>121 mm</b>	122 mm	122 mm	121 mm	133 mm		135 mm	60 mm	
<b>119 mm</b>	116 mm					135 mm		
<b>Adapter</b>								
<b>Number of vessels per adapter/rotor</b>	12/48	5/20	7/28	5/20	1/4	1/4	-/4	4/16 (MTP) 1/4 (DWP)
<b>Bottom shape</b>	conical	conical	conical	flat with rubber mat	flat with rubber mat	flat, rubber	flat	flat with rubber mat
<b>Centrifugation radius</b>	173 mm	173 mm	180 mm	173 mm	173 mm	180 mm	180 mm	163 mm
<b>Max. RCF</b>	3,100 × g	3,100 × g	3,220 × g	3,100 × g	3,100 × g	3,220 × g	3,220 × g	2,900 × g
<b>Packing</b>	set of 2 pcs.	set of 2 pcs.	set of 4 pcs.	set of 2 pcs.	set of 2 pcs.	set of 2 pcs.	-	set of 2 pcs.
<b>Order no.</b>	5810 722.004	5810 723.000	5825 730.003	5810 739.004	5825 722.000	5810 728.002	-	5810 742.005

# Rotors for 58xx Family



## Rotor A-4-62

- > Swing-bucket rotor with max. speed  $3,220 \times g$  (4,000 rpm)
- > Rotor A-4-62 accommodates tubes and bottles from 0.2 mL to 250 mL as well as plates
- > Aerosol-tight caps<sup>1)</sup> for safe centrifugation of hazardous samples optionally available
- > Rotor, buckets, caps and adapters are autoclavable (121 °C, 20 min)

<sup>1)</sup> Aerosol-tightness tested by Public Health England, Porton Down, UK.

<b>Adapters for Rotor A-4-62</b>							
<b>Tube Volume</b>	1.5 – 2.0 mL	1.2 – 5 mL	2.6 – 7 mL	3 – 15 mL	7 – 17 mL	Eppendorf Tubes® 5.0 mL and 15 mL conical	7 – 18 mL
<b>Max. tube diameter</b>	11 mm	11 mm	13 mm	16 mm	17.5 mm	17.5 mm	20 mm
<b>Max. vessel height</b>	43 mm	123 mm	121 mm	121 mm	118 mm	127 mm	126 mm
<b>Max. vessel height for use with cap/lid<sup>1)</sup></b>	43 mm	115 mm	118 mm	116 mm	114 mm	121 mm	119 mm
<b>Adapter</b>							
<b>Number of vessels per adapter/rotor</b>	16/64	25/100	15/60	12/48	12/48	9/36	8/32
<b>Bottom shape</b>	flat	flat with rubber mat	flat with rubber mat	flat with rubber mat	flat with rubber mat	conical	flat with rubber mat
<b>Centrifugation radius</b>	171 mm	173 mm	173 mm	173 mm	173 mm	178 mm	173 mm
<b>Max. RCF</b>	$3,000 \times g$	$3,050 \times g$	$3,050 \times g$	$3,050 \times g$	$3,050 \times g$	$3,150 \times g$	$3,050 \times g$
<b>Packing</b>	set of 2 pcs.	set of 2 pcs.	set of 2 pcs.	set of 2 pcs.	set of 2 pcs.	set of 2 pcs.	set of 2 pcs.
<b>Order no.</b>	5810 751.004	5810 750.008	5810 752.000	5810 753.007	5810 754.003	5810 755.000	5810 756.006

<sup>1)</sup> Exceeding the maximum tube length may reduce the loading capacity of the rotor. Please perform a manual swing-out test before starting the centrifuge run to make sure the tubes do not hit the rotor yoke.

<sup>2)</sup> Please order adapter for 50 mL conical tubes skirted 5804 737.008.<sup>3)</sup> Please note that these conical bottles need to be used together with a conical form insert provided by the manufacturer.

## Ordering information

Description	Order no.
<b>Rotor A-4-62</b> , incl. 4 × 250 mL rectangular buckets	5810 709.008
<b>Rotor A-4-62</b> , with 4 MTP buckets	5810 711.002
<b>Rectangular bucket 250 mL</b> , for Rotor A-4-62, 4 pieces	5810 716.004
<b>MTP bucket</b> , for Rotor A-4-62-MTP, for 4 MTP or 1 DWP, set of 4 pcs.	5810 702.003
<b>Aerosol-tight cap</b> , for rectangular bucket 250 mL, 2 pieces	5810 710.006

18 – 30 mL	30 – 50 mL round-bottom/50 mL conical, skirted <sup>2)</sup>	50 mL conical	50 mL conical	50 – 75 mL	80 – 120 mL	200 – 250 mL flat/175 – 225 mL conical <sup>3)</sup>	MTP, DWP, PCR plates
26 mm		31 mm	31 mm	35 mm	45 mm	62 mm	
119 mm	115 mm	122 mm	122 mm	122 mm	138 mm	136 mm	53 mm
116 mm	113 mm		116 mm	118 mm	125 mm	127 mm	
4/16	4/16	4/16	3/12	2/8	1/4	1/4	4/16 (MTP) 1/4 (DWP)
flat with rubber mat	flat with rubber mat	flat with conical inlay	conical	flat with rubber mat	flat with rubber mat	flat with rubber mat	flat with rubber mat
173 mm	173 mm	173 mm	178 mm	173 mm	173 mm	180 mm	154 mm
$3,050 \times g$	$3,050 \times g$	$3,050 \times g$	$3,150 \times g$	$3,050 \times g$	$3,050 \times g$	$3,220 \times g$	$2,750 \times g$
set of 2 pcs.	set of 2 pcs.	set of 2 pcs.	set of 2 pcs.	set of 2 pcs.	set of 2 pcs.	set of 2 pcs.	set of 4 pcs.
5810 757.002	5810 759.005	5810 763.002	5810 758.009	5810 760.003	5810 761.000	5810 770.009	5810 702.003



# Rotors for 58xx Family



## Rotor S-4-72

- > Medium capacity swing-bucket rotor with speed up to 3,234 × g (4,200 rpm)<sup>1)</sup>
- > Broad range of adapters available to handle all common tube formats from 0.2 mL to 250 mL
- > Aerodynamic round bucket design for up to 48 % energy savings compared to Rotor A-4-62
- > Buckets and adapters are autoclavable (121 °C, 20 min)



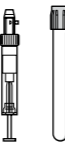
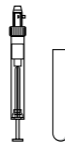
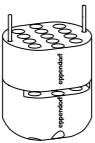
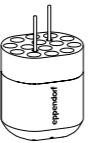
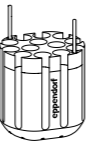
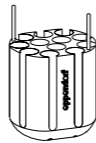





<sup>1)</sup> Please note that a software upgrade will be necessary for older centrifuges when using this rotor. Please contact your local Eppendorf organization or dealer for further information.

				
<b>Adapters for Rotor S-4-72</b>				
<b>Tube Volume</b>	1.5/2.0 mL	2.6 – 8 mL	5.5 – 12 mL	9 mL
<b>Max. tube diameter</b>	11 mm	13 mm	16 mm	17.5 mm
<b>Max. vessel height</b>	43 mm	115 mm	112 mm	113 mm
<b>Adapter</b>				
<b>Number of vessels per adapter/rotor</b>	26/104	14/56	13/52	12/48
<b>Bottom shape</b>	flat	round	round	round
<b>Centrifugation radius</b>	159 mm	159 mm	157 mm	158 mm
<b>Max. RCF</b>	3,136 × g	3,136 × g	3,096 × g	3,116 × g
<b>Packing</b>	set of 2 pcs.	set of 2 pcs.	set of 2 pcs.	set of 2 pcs.
<b>Order no.</b>	5804 794.001	5804 789.008	5804 791.002	5804 792.009

<sup>1)</sup> For Eppendorf Tubes® 5.0 mL with screw cap the capacity is limited to 6 tubes per adapter. <sup>2)</sup> Please note that these conical bottles need to be used together with a conical form insert provided by the manufacturer.

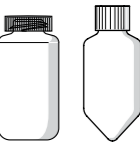
## Ordering information

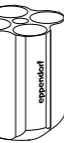
Description	Order no.
Rotor S-4-72, incl. 4 × 250 mL round buckets	5804 746.007

				
Eppendorf Tubes® 5.0 mL	15 mL conical	50 mL conical	50 mL conical, skirted	250 mL flat/175 mL Falcon <sup>2)</sup>
17 mm	17 mm	31 mm	31 mm	62 mm
60 mm	120 mm	120 mm	120 mm	130 mm
				
8/32 <sup>1)</sup>	8/32	4/16	2/8	1/4
conical	conical	conical	conical	flat
163 mm	164 mm	164 mm	153 mm	160 mm
3,215 × g	3,234 × g	3,234 × g	3,017 × g	3,175 × g
set of 2 pcs.	set of 2 pcs.	set of 2 pcs.	set of 2 pcs.	set of 2 pcs.
5804 793.005	5804 783.000	5804 784.006	5804 785.002	5804 787.005

# Rotors for 58xx Family



## Rotor A-4-44

- > High-speed swing-bucket rotor for applications up to 4,500 × g (5,000 rpm)
- > Rotor A-4-44 accommodates tubes from 0.2 mL to 100 mL
- > Aerosol-tight caps<sup>1)</sup> for safe centrifugation of hazardous samples optionally available
- > Rotor, buckets, caps and adapters are autoclavable (121 °C, 20 min)

<sup>1)</sup> Aerosol-tightness tested by Public Health England, Porton Down, UK.

<b>Adapters for Rotor A-4-44</b>							
<b>Tube Volume</b>	1.5 – 2.0 mL	1.2 – 5 mL	2.6 – 7 mL	3 – 15 mL	7 – 17 mL	Eppendorf Tubes® 5.0 mL and 15 mL conical	15 mL conical
<b>Max. tube diameter</b>	11 mm	11 mm	13 mm	16 mm	17.5 mm	17.5 mm	17.5 mm
<b>Max. vessel height</b>	43 mm	105 mm	108 mm	108 mm	110 mm	121 mm	121 mm
<b>Max. vessel height for use with cap/lid<sup>1)</sup></b>	43 mm	102 mm	106 mm	106 mm	106 mm		121 mm
<b>Adapter</b>							
<b>Number of vessels per adapter/rotor</b>	12/48	14/56	9/36	7/28	6/24	4/16	2/8
<b>Bottom shape</b>	flat	flat with rubber mat	flat with rubber mat	flat with rubber mat	flat with rubber mat	conical	conical
<b>Centrifugation radius</b>	148 mm	150 mm	150 mm	150 mm	150 mm	155 mm	157 mm
<b>Max. RCF</b>	4,100 × g	4,200 × g	4,200 × g	4,200 × g	4,200 × g	4,300 × g	4,400 × g
<b>Packing</b>	set of 2 pcs.	set of 2 pcs.	set of 2 pcs.	set of 2 pcs.	set of 2 pcs.	set of 2 pcs.	set of 2 pcs.
<b>Order no.</b>	5804 751.000	5804 750.004	5804 752.007	5804 753.003	5804 754.000	5804 755.006	5804 717.007

<sup>1)</sup> Exceeding the maximum tube length may reduce the loading capacity of the rotor. Please perform a manual swing-out test before starting the centrifuge run to make sure the tubes do not hit the rotor yoke.

<sup>2)</sup> Reordering of 50 mL form inserts: 5804 728.009.<sup>3)</sup> Please order adapter for 50 mL conical tubes skirted 5804 737.008.

## Ordering information

Description	Order no.
<b>Rotor A-4-44</b> , incl. 4 rectangular buckets 100 mL	5804 709.004
<b>Rotor A-4-44</b> , incl. 4 buckets for 2 × 50 mL conical tubes	5804 719.000
<b>Bucket for 2 × 50 mL conical tubes</b> , for Rotor A-4-44, set of 4 pcs.	5804 706.005
<b>Rectangular bucket 100 mL</b> , for Rotor A-4-44, set of 4 pcs.	5804 741.005
<b>Aerosol-tight cap</b> , for rectangular bucket 100 mL, 2 pieces	5804 712.005
<b>Insert</b> , for 1 conical tube 50 mL, set of 8 pieces	5804 728.009
<b>Adapter</b> , for 50 mL conical tubes with skirted bottom, set of 8 pieces	5804 737.008

7 – 18 mL	18 – 30 mL	50 mL <sup>2)</sup> conical	50 mL conical	50 mL conical	30 – 50 mL round-bottom/50 mL conical, skirted <sup>3)</sup>	50 – 75 mL	80 – 100 mL
20 mm	26 mm	-	31 mm	31 mm	31 mm	35 mm	45 mm
107 mm	110 mm	120 mm	122 mm	122 mm	122 mm	119 mm	114 mm
104 mm	100 mm			119 mm	108 mm	108 mm	100 mm
4/16	2/8	-/8	1/4	1/4	1/4	1/4	1/4
flat with rubber mat	flat with rubber mat	flat with conical inlay	conical	conical	flat with rubber mat	flat with rubber mat	flat with rubber mat
150 mm	150 mm	161 mm	155 mm	157 mm	150 mm	150 mm	150 mm
4,200 × g	4,200 × g	4,500 × g	4,300 × g	4,400 × g	4,200 × g	4,200 × g	4,200 × g
set of 2 pcs.	set of 2 pcs.	set of 4 pcs.	set of 2 pcs.	set of 2 pcs.	set of 2 pcs.	set of 2 pcs.	set of 2 pcs.
5804 756.002	5804 757.009	5804 706.005	5804 758.005	5804 718.003	5804 759.001	5804 760.000	5804 761.006

# Rotors for 58xx Family



## Rotor F-34-6-38

- > High-speed rotor for molecular applications in tubes from 0.2 mL to 85 mL
- > Max. speed: 18,500 × g (12,000 rpm) in Centrifuge 5810 R or 15,500 × g (11,000 rpm) in 5804/5804 R/5810<sup>1)</sup>
- > Low rotor weight (3.2 kg) for easy handling
- > 34° borehole angle reduces pellet smears along tube wall
- > Anodized aluminum for high chemical resistance
- > Rotor, lid and adapters are autoclavable (121 °C, 20 min)

<sup>1)</sup> Rotors F-34-6-38 and FA-45-6-30 maintain 4 °C at 11,000 rpm

<b>Adapters for Rotor F-34-6-38</b>					
<b>Tube Volume</b>	1.5 – 2.0 mL	2.6 – 7 mL	2.6 – 7 mL	7 – 15 mL	Eppendorf Tubes® 5.0 mL
<b>Max. tube diameter</b>	11 mm	13 mm	13 mm	16 mm	17 mm
<b>Max. vessel height for use with cap/lid</b>	110 mm	90 mm	110 mm	112 mm	104 mm
<b>Adapter</b>					
<b>Number of vessels per adapter/rotor</b>	4/24	3/18	3/18	2/12	1/6
<b>Bottom shape</b>	round	flat	flat	round	conical
<b>Centrifugation radius</b>	113 mm	106 mm	114 mm	112 mm	105 mm
<b>Max. RCF at 12.100 rpm (5810 R)</b>	18,200 × g	17,065 × g	18,353 × g	18,000 × g	16,824 × g
<b>Max. RCF at 11.000 rpm (5804, 5804 R, 5810)</b>	15,300 × g	14,339 × g	15,422 × g	15,150 × g	14,150 × g
<b>Packing</b>	set of 2 pcs.	set of 2 pcs.	set of 2 pcs.	set of 2 pcs.	set of 2 pcs.
<b>Order no.</b>	5804 770.005	5804 738.004	5804 739.000	5804 771.001	5804 777.000

i For more information go to [www.eppendorf.com/centrifugation](http://www.eppendorf.com/centrifugation)

Technical specifications subject to change.

## Ordering information

Description	Order no.
<b>Rotor F-34-6-38</b> , for 6 × 85 mL tubes, incl. rotor lid	5804 727.002

15 mL conical	15 – 18 mL	20 – 30 mL	50 mL	50 mL conical	85 mL
17 mm	18 mm	26 mm	29 mm	31 mm	38 mm
123 mm	123 mm	123 mm	123 mm	121 mm	121 mm
					—
1/6	1/6	1/6	1/6	1/6	–/6
conical	round	round	round	conical	round
107 mm	109 mm	110 mm	112 mm	108 mm	115 mm
17,200 × g	17,550 × g	17,700 × g	18,000 × g	17,400 × g	18,500 × g
14,450 × g	14,750 × g	14,900 × g	15,150 × g	14,600 × g	15,500 × g
set of 2 pcs.	set of 2 pcs.	set of 2 pcs.	set of 2 pcs.	set of 2 pcs.	–
5804 776.003	5804 772.008	5804 773.004	5804 774.000	5804 775.007	–

Your local distributor: [www.eppendorf.com/contact](http://www.eppendorf.com/contact)  
Eppendorf AG · Barkhausenweg 1 · 22339 Hamburg · Germany · [eppendorf@eppendorf.com](mailto:eppendorf@eppendorf.com) · [www.eppendorf.com](http://www.eppendorf.com)

## Rotors for 58xx Family



### Rotor FA-45-6-30

- > High-speed rotor for applications in tubes from 5 – 50 mL<sup>1)</sup>
- > Max. speed 20,130 × g (12,100 rpm) in Centrifuge 5810 R or 16,639 × g (11,000 rpm) in 5804/5804 R/5810<sup>2)</sup>
- > Eppendorf QuickLock rotor lid for fast lid locking
- > Aerosol-tight<sup>3)</sup> for safe centrifugation of hazardous samples
- > Low rotor weight (3.2 kg) for easy lifting
- > Anodized aluminum for high chemical resistance
- > 45° borehole angle minimizes pellets smear
- > Rotor, lid and adapters are autoclavable (121 °C, 20 min)

<sup>1)</sup> Please note that a software upgrade may be necessary for older centrifuges when using this rotor. Please contact your local Eppendorf organization or dealer for further information.

<sup>2)</sup> Rotors F-34-6-38 and FA-45-6-30 maintain 4 °C at 11,000 rpm

<sup>3)</sup> Aerosol-tightness tested by Public Health England, Porton Down, Great Britain

#### Ordering information

Description	Order no.
Rotor FA-45-6-30, incl. rotor lid, for 6 × 15/50 mL conical tubes	5820 715.006

<b>Adapters for Rotor FA-45-6-30</b>					
<b>Tube Volume</b>	2.6 – 5 mL	4 – 8 mL	5.5 – 10 mL	7.5 – 12 mL	Eppendorf Tubes® 5.0 mL
<b>Max. tube diameter</b>	13 mm	13 mm	16 mm	16 mm	17 mm
<b>Max. vessel height for use with cap/lid</b>	119 mm	119 mm	119 mm	119 mm	121 mm
<b>Adapter</b>					
<b>Number of vessels per adapter/rotor</b>	1/6	1/6	1/6	1/6	1/6 <sup>1)</sup>
<b>Bottom shape</b>	round	round	round	round	conical
<b>Centrifugation radius</b>	120 mm	120 mm	120 mm	120 mm	121 mm
<b>Max. RCF at 12.100 rpm (5810 R)</b>	19,642 × g	19,642 × g	19,642 × g	19,642 × g	19,806 × g
<b>Max. RCF at 11.000 rpm (5804, 5804 R, 5810)</b>	16,233 × g	16,233 × g	16,233 × g	16,233 × g	16,369 × g
<b>Packing</b>	set of 2 pcs.	set of 2 pcs.	set of 2 pcs.	set of 2 pcs.	set of 2 pcs.
<b>Order no.</b>	5820 726.008	5820 725.001	5820 728.000	5820 727.004	5820 730.005

<sup>1)</sup> Eppendorf Tubes® 5.0 mL with screw cap will not fit in this adapter.

## Eppendorf Conical Tubes

Whether centrifugation, mixing, or other applications – the Eppendorf Conical Tubes 15 mL and 50 mL will perfectly fit into your workflows. They represent the next step in Eppendorf's comprehensive system solutions in liquid, sample and cell handling.

More information: [www.eppendorf.com/conicals](http://www.eppendorf.com/conicals)

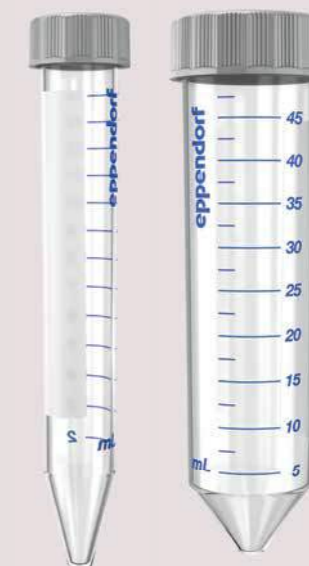



7 – 17 mL	15 mL	15 – 18 mL	20 – 30 mL	35 mL	50 mL conical
17.5 mm	17 mm	18 mm	26 mm	29 mm	31 mm
122 mm	125 mm	125 mm	125 mm	125 mm	121 mm
1/6	1/6	1/6	1/6	1/6	-/6
round	conical	round	round	conical	conical
120 mm	120 mm	120 mm	105 mm	112 mm	123 mm
19,642 × g	19,642 × g	19,642 × g	17,187 × g	18,333 × g	20,130 × g
16,233 × g	16,223 × g	16,223 × g	14,204 × g	16,161 × g	16,639 × g
set of 2 pcs.	set of 2 pcs.	set of 2 pcs.	set of 2 pcs.	set of 2 pcs.	–
5820 729.007	5820 717.009	5820 720.000	5820 721.006	5820 722.002	–

## Progress in Ease of Use and Cooling Performance

The new 59xx family is the successor generation of the 58xx family and provides a large range of improvements not only to the centrifuges themselves but also to the accessories (rotors, adapters).

Centrifuges 5910 R and 5920 R come with a modern operating system with outstanding functionality. Both models include a powerful state-of-the-art refrigeration system with advanced temperature management to keep your samples safe. Last but not least, noise levels have been reduced even further compared to 5810 R.

	5804/5804 R and 5810/5810 R	5910 R, 5920 R
<b>Display/operating system</b>		
<b>Menu-driven display</b>	no	yes
<b>Multilingual operation menu</b>	no	yes
<b>Programs</b>	35	99
<b>Program keys</b>	no	yes (5 programm keys)
<b>Timer</b>	1 min to 99 min	10 s - 99 h 59 min
<b>USB port for easy software upgrades</b>	No	Yes
<b>Ergonomics</b>		
<b>Noise level (swing-bucket rotors)</b>	Low	Very low <sup>1)</sup>
<b>Cooling performance</b>		
<b>Performance</b>	Good	Very good <sup>2)</sup>
<b>FastTemp (pre-cooling function)</b>	Medium	Fast <sup>3)</sup>
<b>FastTemp pro (programmable precooling)</b>	no	yes
<b>ECO shut off</b>	8 hours (fixed)	8 hours (adjustable)

<sup>1)</sup> For swing-bucket rotors generally lower noise levels for comparable rotors, even at higher speed. Example: 5910 R and 5920 R spin the 4x750 mL swing-bucket rotor both faster and quieter than 5810 R.  
<sup>2)</sup> 5910 R and 5920 R can reach lower temperatures than 5810 R with comparable rotors at same speed/similar temperatures at higher speed. Example: Fixed-angle rotor 6x50 mL maintains 4° C at 16,639 x g in 5810 R and 20,130 x g in 5910 R. <sup>3)</sup> Improved function estimated to be implemented in production ca. Q3/2018.

## Progress in Rotor Versatility

The new Centrifuges 5910 R and 5920 R provide significant improvements to those customers who need to spin both plates and conical tubes.

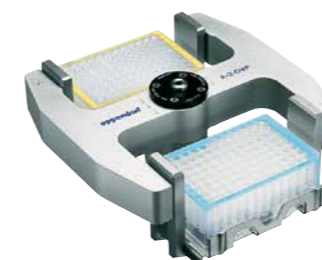

**Centrifuge 5804/5804 R**  
Two separate rotors needed.



**Centrifuge 5810/5810 R**  
Rotor A-4-62 with plate and tube buckets

Advantage:  
Only one rotor but two complete sets of buckets needed



**Centrifuge 5810/5810 R**  
Mixed loading capability:  
Rotors S-4-104 and A-4-81 allow for mixed loading with 2 plate buckets and 2 round/rectangular buckets.

Advantage:  
No need to buy a complete set of 4 plate buckets.



**Centrifuge 5910 R and 5920 R**  
Rotors with universal buckets: Dual use of plates and tubes in one rotor bucket

Advantages:  
> Time saving: No need to exchange buckets  
> Cost saving: No need for separate plate buckets



**Centrifuge 5910 R**  
Rotor S-4xUniversal with universal buckets + universal adapters:  
Three new innovative 'universal adapters' can spin selective conical tube and plate formats:  
> Eppendorf Tubes® 5.0 mL/15 mL conical/DWP  
> 50 mL conical/MTP  
> 50 mL conical/250 mL/MTP

Advantage:  
Cost saving: No need for either separate plate buckets or adapters



# NEW - Centrifuge 5910 R

## Description

Centrifuge 5910 R combines a high capacity of up to 4 x 750 mL with extraordinary versatility. Its main swing-bucket rotor holds both conical tubes and plates – no need to change rotor buckets or adapters. This improves handling and saves time. It features a powerful state-of-the-art refrigeration system with advanced temperature management to keep your samples safe.



### 1. Outstanding rotor versatility

Swing-bucket rotor with universal buckets for spinning tubes or plates. Universal adapters hold 15 or 50 mL conical tubes and plates. Benefit: No rotor, rotor bucket or adapter change needed.

### 2. High capacity

- > Higher capacity than traditional 3 Liter multipurpose centrifuges
- > Max. 4 x 750 mL / 36 x 50 mL conical / 120 x 5/7 mL blood collection / 20 x MTP

### 3. Menu-operated display

- > Multilingual operation menu with language support for English, German, French and Spanish
- > 5 program keys for easy access to routine programs

### 4. Super quiet operation

- > 5910 R sets a new standard. It's the most quiet multipurpose centrifuge within the Eppendorf product range

### 5. Outstanding cooling performance

- > Dynamic compressor control with ECO shut-off function

## Product features

- > Swing-bucket rotors and adapters accommodate tubes and bottles from 0.2 mL to 750 mL
- > Plate rotor options for centrifugation of all types of MTP, PCR or Deepwell Plates
- > Fixed-angle rotors for high-speed molecular biology applications in tubes from 0.2 mL to 50 mL
- > High centrifugation speed of up to 22,132 x g (14,000 rpm)
- > Aerosol-tight Eppendorf QuickLock® caps and lids allow fast and ergonomic lid locking
- > Centrifuge lid with soft-touch lid closure
- > Quiet operation to improve your work environment
- > Compact footprint saves valuable bench space
- > Automatic rotor recognition and imbalance detection for maximum operational safety

## Additional features for Centrifuge 5910 R

- > Temperature range from -11 °C to 40 °C
- > FastTemp function for quick pre-cooling
- > FastTemp pro® function allows for automatic precooling based on pre-programmable time and date
- > Continuous cooling maintains a constant temperature after the run has been completed – your samples stay cool
- > ECO shut-off engages after 8 hours (adjustable) of non-use to reduce energy consumption and to extend compressor life
- > Dynamic compressor control (DCC) technology for precise cooling performance

## Technical specifications

Model	5910 R
Max. RCF	22,132 x g
Max. RCF with fixed-angle rotor	22,132 x g
Max. RCF with swing-bucket rotor	5,234 x g
Speed	100 – 14,000 rpm (10 rpm steps)
Max. capacity	4 x 750 mL/4 x 5 MTP
Acceleration/braking ramps	10/10
Number of programs	99 (5 program keys)
Timer	10 s to 99 h 59 min, with continuous run function, short-spin
Noise level	
Rotor FA-6x50	<56 dB(A)
Rotor S-4x750	<54 dB(A)
Rotor S-4xUniversal	<53 dB(A)
Power supply	230 V, 50 – 60 Hz
Max. power consumption	1,650 W
Dimensions (W x D x H)	72 x 66 x 37 cm
Footprint (dimensions w/o front panel, WxD)	72 x 62 cm
Height (with open lid)	85 cm
Weight w/o accessories	109 kg
Cooling	refrigerated
Temperature control range	-11 °C to 40 °C

## Ordering information

Description	Order no.
Centrifuge 5910 R, refrigerated, 230 V/50 – 60 Hz	5942 000.010

✂ Ordering information for other voltage options begins on page 434

# Centrifuge 5920 R



As awarded by The Chicago Athenaeum: Museum of Architecture and Design.

## 1. Ergonomic lid operation

- > Soft-touch lid closure and low opening height for stress-free lid locking
- > Two open lid positions
  - > Fully open for easy removal of rotor
  - > Half open for easy access to samples and easy reach of centrifuge lid

## 2. Extraordinary high capacity

- > Max. 4 × 1,000 mL/52 × 50 mL conical/108 × 15 mL conical/196 × 5/7 mL blood collection/28 × MTP

## 3. Outstanding cooling performance

- > Dynamic compressor control with ECO shut-off function

## 4. Menu-operated display

- > Multilingual operation menu with language support for English, German, French and Spanish
- > 5 program keys for easy access to routine programs

## 5. Quiet operation

- > Designed to operate at low noise levels for a relaxing work environment



[www.eppendorf.com/centrifugation-video](http://www.eppendorf.com/centrifugation-video)



## Description

Centrifuge 5920 R delivers extraordinary high capacity in a very compact and ergonomic product design. It has similar dimensions as competing refrigerated 3 Liter models and yet features a superior capacity of up to 4 × 1,000 mL; thus making it the ideal instrument for high-throughput applications. It features a powerful state-of-the-art refrigeration system with advanced temperature management to keep your samples safe.

## Product features

- > Swing-bucket rotors and adapters accommodate tubes and bottles from 0.2 mL to 1,000 mL
- > Plate rotor options for centrifugation of all types of MTP, PCR or Deepwell Plates
- > Fixed-angle rotors for high-speed molecular biology applications in tubes from 0.2 mL to 50 mL
- > High centrifugation speed of up to 21,194 × g (13,700 rpm)
- > Aerosol-tight Eppendorf QuickLock® caps and lids allow fast and ergonomic lid locking
- > Centrifuge lid with soft-touch lid closure
- > Quiet operation to improve your work environment
- > Compact footprint saves valuable bench space
- > Automatic rotor recognition and imbalance detection for maximum operational safety

## Additional features for Centrifuge 5920 R

- > Temperature range from -11 °C to 40 °C
- > FastTemp function for quick pre-cooling
- > FastTemp pro® function allows for automatic precooling based on pre-programmable time and date
- > Continuous cooling maintains a constant temperature after the run has been completed – your samples stay cool
- > ECO shut-off engages after 8 hours (adjustable) of non-use to reduce energy consumption and to extend compressor life
- > Dynamic compressor control (DCC) technology for precise cooling performance

# Centrifuge 5920 R



## 4 Liter capacity

- > Centrifuge 5920 R accommodates standard 1 Liter Nalgene bottles setting a new standard in the table top centrifuge segment

Your benefit: Process higher volume in fewer runs



## High-capacity buckets

Not only do the high-capacity buckets of Rotor S-4x1000 provide an exceptional high capacity (52 x 50 mL conical, 108 x 15 mL conical), they also allow both tubes and plates to be used in the same rotor bucket.

### Advantages:

- > Time saving: No need to exchange buckets
- > Cost saving: No need for separate plate buckets
- > Space saving: No need to store different buckets



## Advanced operating system

Centrifuge 5920 R comes with a modern operating system with outstanding functionality

- > Menu-driven, multi lingual operation menu with large backlit display
- > Saves up to 99 user-defined programs
- > 5 program keys for easy access to routine programs
- > FastTemp pro® function for automated pre-cooling based on pre-programmable time and date

Technical specifications	
Model	5920 R
Max. RCF	21,194 x g
Max. RCF with fixed-angle rotor	21,194 x g
Max. RCF with swing-bucket rotor	4,800 x g
Speed	100 – 13,700 rpm (10 rpm steps)
Max. capacity	4 x 1,000 mL/4 x 7 MTP
Acceleration/braking ramps	10/10
Number of programs	99 (5 program keys)
Timer	10 s to 99 h 59 min, with continuous run function, short-spin
Noise level	
Rotor FA-6x50	<60 dB(A)
Rotor S-4xUniversal-Large	<55 dB(A)
Power supply	230 V, 50 – 60 Hz
Max. power consumption	1,650 W
Dimensions (W x D x H)	74 x 71 x 40 cm
Footprint (dimensions w/o front panel, WxD)	74 x 67 cm
Height (with open lid)	94 cm
Weight w/o accessories	139 kg
Cooling	refrigerated
Temperature control range	-11 °C to 40 °C

## Ordering information

Description	Order no.
Centrifuge 5920 R, refrigerated, keypad, 230 V/50 – 60 Hz	5948 000.010

✂ Ordering information for other voltage options begins on page 434

# Centrifuge Packages 5910 R/5920 R

## Description

Eppendorf provides a range of different centrifuge packages for Centrifuge 5920 R/5910 R.



## Cell Culture Centrifuge packages include

- > Centrifuge 5920 R/5910 R
- > Swing-bucket rotor incl. one bucket type (see next page)
- > Four adapters for 15 mL conical tubes (two sets of 2)
- > Four adapters for 50 mL conical tubes (two sets of 2)

## Centrifuge packages for round-bottom tubes include

- > Centrifuge 5920 R/5910 R
- > Swing-bucket rotor incl. one bucket type (see adjacent)
- > Four adapters for 13 mm (5/7 mL) round bottom tubes (two sets of 2)
- > Four adapters for 16 mm (10 mL) round bottom tubes (two sets of 2)

## Eppendorf Conical Tubes 15 mL and 50 mL

The Eppendorf Conical Tubes 15 mL and 50 mL are the optimal solution for cell culture sample preparation protocols in microbiology and molecular biology laboratories. Safe design and easy handling ensure best sample processing.

## Premium USP class 6 raw material ensures

- > high sample integrity
- > high g-Safe® centrifugation stability
- > optimal sample and pellet visibility

For more information go to chapter „Reaction tubes and plates“ on page 108

## Ordering information

Description	Max. capacity of conical tubes per rotor	Order no.
<b>Centrifuge 5920 R</b> , refrigerated, with Rotor S-4x1000, keypad, 230 V/50 – 60 Hz, incl. high-capacity buckets and adapters for 15 mL/50 mL conical tubes	108 x 15 mL/52 x 50 mL	5948 000.210
<b>Centrifuge 5920 R</b> , refrigerated, with Rotor S-4xUniversal-Large, keypad, 230 V/50 – 60 Hz, incl. universal buckets and adapters for 15 mL/50 mL conical tubes	96 x 15 mL/40 x 50 mL	5948 000.910
<b>Centrifuge 5920 R</b> , refrigerated, with Rotor S-4x1000, keypad, 230 V/50 – 60 Hz, incl. plate/tube buckets and adapters for 15 mL/50 mL conical tubes	88 x 15 mL/40 x 50 mL	5948 000.410
<b>Centrifuge 5920 R</b> , refrigerated, with Rotor S-4x1000, keypad, 230 V/50 – 60 Hz, incl. round buckets and adapters for 15 mL/50 mL conical tubes	56 x 15 mL/28 x 50 mL	5948 000.315
<b>Centrifuge 5910 R</b> , refrigerated, with Rotor S-4xUniversal, 230 V/50 – 60 Hz, incl. universal buckets and adapters for 5 mL/15 mL/50 mL conical tubes and plates <sup>1)</sup>	64 x 15 mL/36 x 50 mL	5942 000.315
<b>Centrifuge 5910 R</b> , refrigerated, with Rotor S-4xUniversal, 230 V/50 – 60 Hz, incl. universal buckets and adapters for 5 mL/15 mL/50 mL conical tubes, 175 mL – 250 mL bottles and plates	64 x 15 mL/28 x 50 mL	5942 000.215
<b>Centrifuge 5910 R</b> , refrigerated, with Rotor S-4x750, 230 V/50 – 60 Hz, incl. round buckets and adapters for 5 mL/15 mL/50 mL conical tubes	56 x 15 mL/28 x 50 mL	5942 000.515
<b>Centrifuge 5910 R</b> , refrigerated, with Rotor S-4x500, 230 V/50 – 60 Hz, incl. rectangular buckets and adapters for 15 mL/50 mL conical tubes	48 x 15 mL/20 x 50 mL	5942 000.615
<b>Centrifuge 5910 R</b> , refrigerated, with Rotor S-4x400, 230 V/50 – 60 Hz, incl. round buckets and adapters for 5 mL/15 mL/50 mL conical tubes	28 x 15 mL/16 x 50 mL	5942 000.710

<sup>1)</sup> When used with aerosol-tight caps the max. capacity is reduced to 20 x 50 mL (5 x 50 mL per bucket)

## Ordering information

Description	Max. capacity of round-bottom tubes per rotor	Order no.
<b>Centrifuge 5920 R</b> , refrigerated, with Rotor S-4xUniversal-Large, keypad, 230 V/50 – 60 Hz, incl. universal buckets and adapters for round-bottom tubes with diameter 13/16 mm	196 x 13 mm/148 x 16 mm	5948 000.810
<b>Centrifuge 5920 R</b> , refrigerated, with Rotor S-4x1000, keypad, 230 V/50 – 60 Hz, incl. plate/tube buckets and adapters for round-bottom tubes with diameter 13/16 mm <sup>1)</sup>	140 x 13 mm/132 x 16 mm	5948 000.615
<b>Centrifuge 5910 R</b> , refrigerated, with Rotor S-4xUniversal, 230 V/50 – 60 Hz, incl. universal buckets and adapters for round-bottom tubes with diameter 13/16 mm	120 x 13 mm/104 x 16 mm	5942 000.410

<sup>1)</sup> Aerosol-tight caps reduce capacity to 100 x 13 mm/92 x 16 mm per rotor.

✂ Ordering information for other voltage options begins on page 434



i For more information go to [www.eppendorf.com/centrifugation](http://www.eppendorf.com/centrifugation)

## Overview of Swing-Buckets Rotors 59xx Family



Model	Rotor S-4xUniversal-Large	Rotor S-4x1000 high-capacity buckets	Rotor S-4x1000 plate/tube buckets	Rotor S-4x1000 round buckets
Positioning	Extra high capacity	Extra high capacity	High capacity	Medium capacity, compatible with 1 Liter bottle
5910 R				
5920 R	■	■	■	■
Universal bucket	yes	yes	yes	no
Aerosol-tightness	yes	no	yes	yes
Max. capacity	4 x 750 mL	8 x 250 mL	40 x 50 mL	4 x 1,000 mL
Max. RCF	4,402 x g	3,153 x g	3,076 x g	3,413 x g
Max. speed	4,250 rpm	3,700 rpm	3,700 rpm	3,700 rpm
1.5/2.0 mL micro tube	368			200
Eppendorf Tubes® 5.0 mL and 15 mL conical	96	108	88	56
50 mL conical	40	52	40	28
13 mm blood tube	196	196	140	92
16 mm blood tube	148	144	132	80
750 mL bottle	4			4
1.000 mL bottle				4
MTP/DWP	20/8	24/8	28/8	28/8



Rotor S-4xUniversal	Rotor S-4x750	Rotor S-4x500	Rotor S-4x400
High capacity and versatility	Medium capacity, high speed	Medium capacity	Medium capacity, high speed
■	■	■	■
yes	no	no	no
yes	yes	yes	yes
4 x 750 mL	4 x 750 mL	4 x 500 mL	4 x 250 mL
4,347 x g	4,800 x g	3,220 x g	5,234 x g
4,500 rpm	4,700 rpm	4,000 rpm	5,100 rpm
	200	96	104
64	56	48	28
36	28	20	16
120	92	100	60
104	80	64	44
4	4		
20/4	16/4	16/4	

## Advanced Rotor Design – Swing-Bucket Rotors



### Rotor buckets for tubes and plates (selected rotors only)

#### Advantages:

- > Time saving: No need to exchange buckets
- > Cost saving: No need for separate plate buckets
- > Space saving: No need to store different bucket



### Aerosol-tight QuickLock caps

- > Significantly improved handling, easy operation with one or two hands
- > Handle allows the closed bucket to be carried to the biosafety cabinet where it can be opened in a safe environment
- > Aerosol-tightness has been tested and verified by Public Health England, Porton Down, UK

For more information go to [www.eppendorf.com/centrifugation](http://www.eppendorf.com/centrifugation)

## Overview of the Main Fixed-Angle Rotors 59xx Family



Model	Rotor FA-6x250 <sup>1)</sup>	Rotor FA-6x50	Rotor FA-20x5
<b>Positioning</b>	Processing of cells in higher volumes at high speed	Molecular applications in tubes up to 50 mL conical	Applications in Eppendorf Tubes® 5.0 mL
<b>5910 R</b>	■	■	■
<b>5920 R</b>	■	■	■
<b>Aerosol-tightness</b>	yes	yes	yes
<b>Max. capacity</b>	6 × 250 mL	6 × 50 mL	20 × 5 mL
<b>Max. RCF</b>		20,130 × g	20,913 × g
<b>Max. speed</b>		12,100 rpm	13,100 rpm
<b>1.5/2.0 mL micro tube</b>		6	20
<b>Eppendorf Tubes® 5.0 mL and 15 mL conical</b>		6	20/0
<b>50 mL conical</b>		6	
<b>250 mL</b>	6		

<sup>1)</sup> Will be expected in Q3/2018.



Model	Rotor FA-48x2	Rotor FA-30x2	Rotor F-48x15
<b>Positioning</b>	Aerosol-tight microcentrifuge tube rotor	Aerosol-tight microcentrifuge tube rotor for safe centrifugation of hazardous samples	High-capacity fixed-angle rotor for 15 mL conical and glass tubes
<b>5910 R</b>	■	■	■
<b>5920 R</b>	■	–	–
<b>Aerosol-tightness</b>	yes	yes	
<b>Max. capacity</b>	48 × 2 mL	30 × 2 mL	40 × 15 mL
<b>Max. RCF</b>	21,194 × g (5920 R)/22,132 × g (5910 R)	20,984 × g	
<b>Max. speed</b>	13,700 rpm (5920 R)/14,000 rpm (5910 R) rpm	13,700 rpm	5,500 rpm
<b>1.5/2.0 mL micro tube</b>	48	30	
<b>Eppendorf Tubes® 5.0 mL and 15 mL conical</b>			0/40
<b>50 mL conical</b>			
<b>250 mL</b>			

## Advanced Rotor Design – Fixed-Angle Rotors



Cross section of Rotor FA-6x50 (6 × 50 mL conical) showing the light-weight design. All metal not needed for safety or performance is hollowed out to reduce weight and improve handling.

### Low rotor weight

Eppendorf's fixed-angle rotors are among the lightest in the industry to improve handling and operational safety. Light-weight rotors cause less wear and tear on the motor and allow for faster acceleration and braking times.

### Eppendorf QuickLock® lids for ergonomic lid locking

Our aerosol-tight QuickLock rotors close with only ¼ of a turn. This not only saves you time during every day use, it also takes repetitive stress off your wrist.

### Superior temperature control

Aluminum, with its high heat conductivity, allows fast pre-cooling and accurate temperature control in refrigerated centrifuges.



### Perfect fit with Eppendorf Conical Tubes 15 mL and 50 mL

The Eppendorf Conical Tubes are characterized by an outstanding centrifugation stability of up to 19,500 × g<sup>1)</sup>. This makes them suited for a broad range of applications.

<sup>1)</sup> Test conditions: Rotor FA-45-6-30 in Eppendorf Centrifuge 5810 R (using a suitable centrifuge adapter for 15 mL tube), sample: Saline solution (density: 1.0 g/mL), controlled centrifugation temp.: 25 °C, centrifugation time: 90 min

For more information go to [www.eppendorf.com/centrifugation](http://www.eppendorf.com/centrifugation)

## Rotors for 5920 R





**Rotor S-4xUniversal-Large**





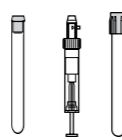
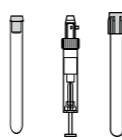

- > Extra high capacity swing-bucket rotor with max. speed 4,402 × g (4,250 rpm)
- > Broad range of adapters enables high versatility for tubes and flasks from 0.2 mL to 750 mL and plates
- > Universal bucket design accommodates both plates and tubes
- > Aerosol-tight Eppendorf QuickLock® caps for safe centrifugation of hazardous samples optionally available<sup>1)</sup>
- > Buckets, caps and adapters are autoclavable

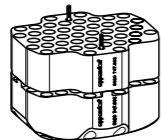
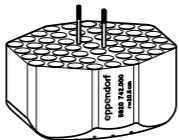
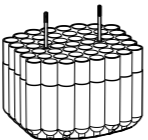
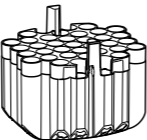
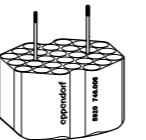
<sup>1)</sup> Aerosol-tightness tested by Public Health England, Porton Down, UK.

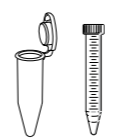
**Ordering information**

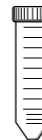

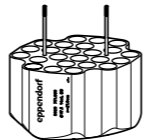
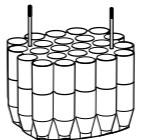
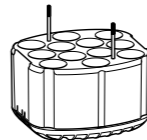
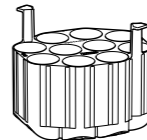

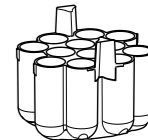







Description	Order no.
<b>Rotor S-4xUniversal-Large</b> , incl. buckets	5895 190.006
<b>Aerosol-tight caps</b> , for Rotor S-4xUniversal-Large, set of 2 pcs.	5920 752.006

					
<b>Adapters for Rotor S-4xUniversal-Large</b>					
<b>Tube Volume</b>	1.5/2.0 mL	5 mL FACS	2.6 – 8 mL	5.5 – 12 mL	9 mL
<b>Max. tube diameter</b>	11 mm	12 mm	13 mm	16 mm	17.5 mm
<b>Max. vessel height</b>	39 mm	113 mm	110 mm	110 mm	136 mm
<b>Max. vessel height for use with cap/lid</b>	39 mm	82 mm	107 mm	106 mm	130 mm
<b>Adapter</b>					
<b>Number of vessels per adapter/rotor</b>	92/368	51/204	49/196	37/148	28/112
<b>Bottom shape</b>	flat	round	round	round	round
<b>Centrifugation radius</b>	205 mm	205 mm	205 mm	204 mm	209 mm
<b>Max. RCF</b>	4,139 × g	4,140 × g	4,140 × g	4,120 × g	4,200 × g
<b>Packing</b>	set of 2 pcs.	set of 2 pcs.	set of 2 pcs.	set of 2 pcs.	set of 2 pcs.
<b>Order no.</b>	5920 747.002	5920 742.000	5920 739.000	5920 738.003	5920 746.006

					
14 mL	Eppendorf Tubes® 5.0 mL and 15 mL conical	30 mL	50 mL conical	50 mL conical, skirted	50 mL Nalgene® Oak Ridge
17.5 mm	17 mm	25 mm	31 mm	31 mm	29 mm
123 mm	131 mm	117 mm	131 mm	141 mm	132 mm
120 mm	123 mm	108 mm	125 mm	121 mm	121 mm
					
24/96	24/96	12/48	10/40	7/28	12/48
round	conical	flat	conical	conical	round
210 mm	218 mm	194 mm	213 mm	197 mm	206 mm
4,240 × g	4,402 × g	3,918 × g	4,301 × g	3,978 × g	4,160 × g
set of 2 pcs.	set of 2 pcs.	set of 2 pcs.	set of 2 pcs.	set of 2 pcs.	set of 2 pcs.
5920 751.000	5920 736.000	5920 743.007	5920 735.004	5920 748.009	5920 753.002

## Rotors for 5920 R

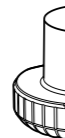

							
<b>Adapters for Rotor S-4xUniversal-Large</b>							
<b>Tube Volume</b>	250 mL flat, 175 – 225 mL conical	250 mL conical (Corning®, Nunc®)	500 mL Corning®	500 mL Nalgene®	750 mL	Micro Fluidic Cards	MTP, DWP, PCR plates
<b>Max. tube diameter</b>	62 mm	62 mm	98 mm	70 mm	104 mm	-	-
<b>Max. vessel height</b>	133 mm	171 mm	160 mm	168 mm	166 mm	153 mm	116 mm
<b>Max. vessel height for use with cap/lid</b>	126 mm		148 mm	145 mm	143 mm		110 mm
<b>Adapter</b>							
<b>Number of vessels per adapter/rotor</b>	2/8	1/4	1/4	1/4	1/4	3/12	5/20 (MTP) 2/8 (DWP)
<b>Bottom shape</b>	flat	flat	conical	flat	flat	flat	flat
<b>Centrifugation radius</b>	203 mm	208 mm	208 mm	206 mm	202 mm	200 mm	196 mm
<b>Max. RCF</b>	4,099 × g	4,200 × g	4,200 × g	4,160 × g	4,079 × g	4,039 × g	3,938 × g
<b>Packing</b>	set of 2 pcs.	set of 2 pcs.	set of 2 pcs.	set of 2 pcs.	set of 2 pcs.	set of 2 pcs.	set of 2 pcs.
<b>Order no.</b>	5920 740.008	5920 750.003	5920 744.003	5920 745.000	5920 741.004	5920 749.005	5920 737.007

## Get +Together

**A perfect match**

Do you spin both conical tubes and plates? Eppendorf may have the perfect solution for you. Eppendorf offers a comprehensive range of high quality consumables and now introduces the new refrigerated Centrifuge 5920 R, featuring extraordinary high capacity and performance. Its main swing-bucket rotor allows for spinning both plates and tubes in the same bucket.

**Your benefits:**

- > Cost saving: No need for separate plate buckets
- > Space saving: No need to store different buckets
- > Time saving: No need to exchange buckets
- > Optimal complementarity and performance with Eppendorf Consumables

**Learn more about the products. For easiest access, just scan the QR code.**

Alternatively, visit [www.eppendorf.com/together](http://www.eppendorf.com/together)



## Rotors for 5920 R



**Rotor S-4x1000 with High-Capacity Buckets**

- > Extra high capacity swing-bucket rotor with max. speed 3,153 x g (3,700 rpm)
- > Bucket accommodates both plates and tubes
- > Buckets, caps and adapters are autoclavable

**Ordering information**

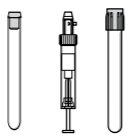
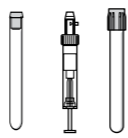
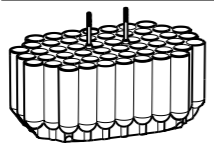
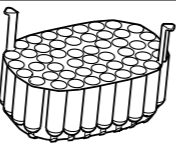
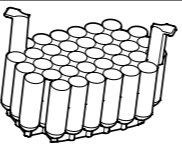
Description	Order no.
<b>Rotor S-4x1000</b> , incl. high-capacity buckets	5895 118.003
<b>Rotor S-4x1000</b> , without buckets	5895 101.003
<b>Buckets for Rotor S-4x1000</b> , High-Capacity bucket for Rotor S-4x1000, set of 2 pcs.	5895 107.001
<b>Buckets for Rotor S-4x1000</b> , High-Capacity bucket for Rotor S-4x1000, set of 4 pcs.	5895 106.005
<b>Plate carrier for high-capacity bucket</b> , set of 2 pcs.	5920 729.004

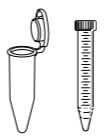
			
<b>Adapters for Rotor S-4x1000 high-capacity buckets</b>			
<b>Tube Volume</b>	5 mL FACS	2.6 – 8 mL	5.5 – 12 mL
<b>Max. tube diameter</b>	12 mm	13 mm	16 mm
<b>Max. vessel height</b>	106 mm	112 mm	113 mm
<b>Adapter</b>			
<b>Number of vessels per adapter/rotor</b>	52/204	49/196	36/144
<b>Bottom shape</b>	round	round	round
<b>Centrifugation radius</b>	204 mm	204 mm	199 mm
<b>Max. RCF</b>	3,122 x g	3,122 x g	3,046 x g
<b>Packing</b>	set of 2 pcs.	set of 2 pcs.	set of 2 pcs.
<b>Order no.</b>	5920 724.002	5920 718.002	5920 720.007

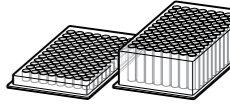
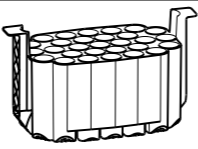
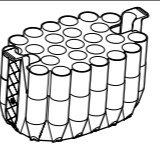
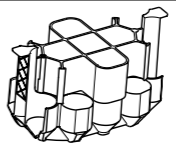
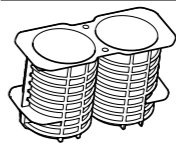
				
<b>Tube Volume</b>	9 mL	Eppendorf Tubes® 5.0 mL and 15 mL conical	50 mL conical	250 mL flat, 175 – 225 mL conical and Nunc 250 mL conical
<b>Max. tube diameter</b>	17.5 mm	17 mm	31 mm	62 mm
<b>Max. vessel height</b>	129 mm	120 mm	120 mm	145 mm
<b>Adapter</b>				
<b>Number of vessels per adapter/rotor</b>	29/116	27/108	13/52	2/8
<b>Bottom shape</b>	round	conical	conical	flat
<b>Centrifugation radius</b>	204 mm	205 mm	206 mm	200 mm
<b>Max. RCF</b>	3,122 x g	3,138 x g	3,163 x g	3,061 x g
<b>Packing</b>	set of 2 pcs.	set of 2 pcs.	set of 2 pcs.	set of 2 pcs.
<b>Order no.</b>	5920 722.000	5920 716.000	5920 715.003	5920 717.006

## Rotors for 5920 R

**Rotor S-4x1000 with Plate/Tube Bucket**

- > High capacity swing-bucket rotor with max. speed 3,076 × g (3,700 rpm)
- > Bucket accommodates both plates and tubes
- > Aerosol-tight QuickLock caps for safe centrifugation of hazardous samples optionally available<sup>1)</sup>
- > Buckets, caps and adapters are autoclavable

<sup>1)</sup> Aerosol-tightness tested by Public Health England, Porton Down, UK.

**Ordering information**

Description	Order no.
<b>Rotor S-4x1000</b> , aerosol-tight, incl. plate/tube buckets	5895 117.007
<b>Rotor S-4x1000</b> , aerosol-tight, without buckets	5895 101.003
<b>Aerosol-tight caps</b> , for S-4x1000 plate/tube bucket and S-4x750 plate bucket, set of 2 pcs.	5895 111.009
<b>Buckets for Rotor S-4x1000</b> , Plate/tube bucket for Rotor S-4x1000, set of 2 pcs.	5895 105.009
<b>Buckets for Rotor S-4x1000</b> , Plate/tube bucket for Rotor S-4x1000, set of 4 pcs.	5895 104.002
<b>Plate carrier for plate/tube bucket</b> , for Rotor S-4x1000 with plate/tube buckets, Rotor S-4x1000, set of 2 pcs.	5920 705.008

**Adapters for Rotor S-4x1000 plate/tube buckets**

Tube Volume	2.6 – 8 mL	5.5 – 12 mL	9 mL	Eppendorf Tubes® 5.0 mL and 15 mL conical
Max. tube diameter	13 mm	16 mm	17.5 mm	17 mm
Max. vessel height	109 mm	109 mm	109 mm	121 mm
Max. vessel height for use with cap/lid <sup>1)</sup>	108 <sup>2)</sup> mm	108 <sup>3)</sup> mm	109 <sup>4)</sup> mm	
Adapter				
Number of vessels per adapter/rotor	35/140	33/132	28/112	22/88
Bottom shape	round	round	round	conical
Centrifugation radius	201 mm	200 mm	200 mm	201 mm
Max. RCF	3,076 × g	3,061 × g	3,061 × g	3,076 × g
Packing	set of 2 pcs.	set of 2 pcs.	set of 2 pcs.	set of 2 pcs.
Order no.	5920 706.004	5920 707.000	5920 708.007	5920 710.001

<sup>1)</sup> Please perform a manual test to determine the actual loading capacity.<sup>2)</sup> in 25 center pos.<sup>3)</sup> in 23 center pos.<sup>4)</sup> in 22 center pos.

Eppendorf Tubes® 5.0 mL and 15 mL conical	50 mL conical	50 mL conical	MTP, DWP, PCR plates
17 mm	31 mm	31 mm	
121 mm	122 mm	121 mm	104 mm
121 mm		121 mm	91 mm
16/64	10/40	7/28	7/28(MTP) 2/8(DWP)
conical	conical	conical	flat
201 mm	201 mm	201 mm	198 mm
3,076 × g	3,076 × g	3,076 × g	3,030 × g
set of 2 pcs.	set of 2 pcs.	set of 2 pcs.	set of 2 pcs.
5920 712.004	5920 709.003	5920 711.008	5920 705.008

# Rotors for 5920 R



## Rotor S-4x1000 with Round Bucket

- > Medium capacity swing-bucket rotor with max. speed 3,413 x g (3,700 rpm)
- > Broad range of adapters enables high versatility for tubes and flasks from 0.2 mL to 1,000 mL and plates
- > Mixed loading with 2 plate buckets and 2 round tube buckets allows for increased versatility
- > Aerosol-tight QuickLock caps for safe centrifugation of hazardous samples optionally available<sup>1)</sup>
- > Buckets, caps and adapters are autoclavable

<sup>1)</sup> Aerosol-tightness tested by Public Health England, Porton Down, UK.

<b>Adapters for Rotor S-4x1000 round buckets</b>							
<b>Tube Volume</b>	1.5/2.0 mL	12 x 75 mm, 5 mL FACS	2.6 – 8 mL	5.5 – 12 mL	9 mL	14 mL	Eppendorf Tubes® 5.0 mL and 15 mL conical
<b>Max. tube diameter</b>	11 mm	12 mm	13 mm	16 mm	17.5 mm	17.5 mm	17 mm
<b>Max. vessel height</b>	39 mm	115 mm	121 mm	140 mm	117 mm	117 mm	161 mm
<b>Max. vessel height for use with cap/lid<sup>1)</sup></b>	39 mm	108 mm	113 mm	140 mm	112 mm	112 mm	150 mm
<b>Adapter</b>							
<b>Number of vessels per adapter/rotor</b>	50/200	27/108	23/92	20/80	20/80	14/56	14/56
<b>Bottom shape</b>	flat	round	round	round	round	round	conical
<b>Centrifugation radius</b>	219 mm	211 mm	210 mm	211 mm	210 mm	210 mm	224 mm
<b>Max. RCF</b>	3,352 x g	3,229 x g	3,214 x g	3,229 x g	3,214 x g	3,214 x g	3,428 x g
<b>Packing</b>	set of 2 pcs.	set of 2 pcs.	set of 2 pcs.	set of 2 pcs.	set of 2 pcs.	set of 2 pcs.	set of 2 pcs.
<b>Order no.</b>	5825 740.009	5825 747.003	5825 738.004	5825 736.001	5825 743.008	5825 748.000	5825 734.009

<sup>1)</sup> Exceeding the maximum tube length may reduce the loading capacity of the rotor. Please perform a manual swing-out test before starting the centrifuge run to make sure the tubes do not hit the rotor yoke.

<sup>2)</sup> Please note that these conical bottles need to be used together with a conical form insert provided by the manufacturer. <sup>3)</sup> 225 mL conical for S-4-104 and S-4x750, 250 mL conical for S-4x1000 with round bucket.

## Ordering information

Description	Order no.
<b>Aerosol-tight caps for 750 mL round buckets</b> , aerosol-tight, for Rotor S-4-104, Rotor S-4x750 and Rotor S-4x1000, set of 2 pcs.	5820 747.005
<b>Rotor S-4x1000</b> , aerosol-tight, without buckets	5895 101.003
<b>Buckets for Rotor S-4x1000</b> , Round bucket for Rotor S-4x1000, set of 2 pcs.	5895 103.006
<b>Buckets for Rotor S-4x1000</b> , Round bucket for Rotor S-4x1000, set of 4 pcs.	5895 102.000
<b>Rotor S-4x1000 round buckets</b> , aerosol-tight, incl. 4 x 1,000 mL round buckets	5895 100.007
<b>Aerosol-tight caps</b> , for S-4x1000 plate/tube bucket and S-4x750 plate bucket, set of 2 pcs.	5895 111.009
<b>Buckets for Rotor S-4x1000</b> , Plate/tube bucket for Rotor S-4x1000, set of 2 pcs.	5895 105.009
<b>Buckets for Rotor S-4x1000</b> , Plate/tube bucket for Rotor S-4x1000, set of 4 pcs.	5895 104.002
<b>Plate carrier for plate/tube bucket</b> , for Rotor S-4x1000 with plate/tube buckets, Rotor S-4x1000, set of 2 pcs.	5920 705.008

30 mL	50 mL conical	50 mL conical, skirted	250 mL flat, 175 – 225/250 mL conical <sup>2) 3)</sup>	500 mL Corning® Nunc®	500 mL Nalgene	600 mL TPP	750 mL	1 Liter Nalgene	MTP, DWP, PCR plates
25 mm	31 mm	31 mm	62 mm	98 mm		98 mm	104 mm	98 mm	
145 mm	156 mm	151 mm	176 mm	167 mm	180 mm	181 mm	150 mm	185 mm	104 mm
138 mm	150 mm	147 mm	156 mm						91 mm
8/32	7/28	5/20	1/4	1/4	1/4	1/4	1/4	1/4	7/28 (MTP) 2/8 (DWP)
flat	conical	conical	flat	conical	flat	conical	flat	flat	flat
210 mm	223 mm	209 mm	214 mm	218 mm	221 mm	224 mm	216 mm	218 mm	198 mm
3,222 x g	3,413 x g	3,199 x g	3,275 x g	3,336 x g	3,382 x g	3,428 x g	3,306 x g	3,336 x g	3,030 x g
set of 2 pcs.	set of 2 pcs.	set of 2 pcs.	set of 2 pcs.	set of 2 pcs.	set of 2 pcs.	set of 2 pcs.	set of 2 pcs.	set of 2 pcs.	set of 2 pcs.
5825 755.006	5825 733.002	5825 732.006	5825 741.005	5825 745.000	5920 703.005	5920 701.002	5825 744.004	5920 700.006	5895 105.009

## Rotors for 5910 R



## Rotor S-4xUniversal

- > High capacity swing-bucket rotor with max. speed  $4,347 \times g$  (4,500 rpm)
- > Broad range of adapters enables high versatility for tubes and flasks from 4 mL to 750 mL and plates
- > Universal bucket design accommodates both plates and tubes
- > Universal adapters accommodate selective plate formats and conical tubes
- > Aerosol-tight QuickLock caps for safe centrifugation of hazardous samples optionally available<sup>1)</sup>
- > Buckets, caps and adapters are autoclavable

<sup>1)</sup> Aerosol-tightness tested by Public Health England, Porton Down, UK.



Rotor S-4xUniversal brings outstanding versatility to those customers who need to spin both tubes and plates. Three new innovative 'universal adapters' can spin selective conical tube and plate formats:

- > Eppendorf Tubes® 5.0 mL/15 mL conical/DWP
- > 50 mL conical/MTP
- > 50 mL conical/250 mL flat/MTP

For customers who need either stacking capability, higher speed or aerosol-tight centrifugation of certain plate formats, a separate plate carrier is available.

## Ordering information

Description	Order no.
Rotor S-4xUniversal, incl. universal buckets	5895 200.001
Aerosol-tight caps, for Rotor S-4xUniversal, set of 2 pcs.	5910 750.005
Wide-neck bottle, 750 mL, set of 2 pcs.	5820 708.000

Adapters for Rotor S-4xUniversal	4 mL – 8 mL	7.5 mL – 12 mL	9 mL	Eppendorf Tubes® 5.0 mL	15 mL conical	MTP, DWP
Tube Volume	4 mL – 8 mL	7.5 mL – 12 mL	9 mL			
Max. tube diameter	13 mm	16 mm	17.5 mm	17 mm	17 mm	
Max. vessel height	119 mm	120 mm	120 mm	124 mm	124 mm	64 mm
Max. vessel height for use with cap/lid <sup>1)</sup>	117 mm	118 mm	118 mm	122 mm	122 mm	<sup>2)</sup>
Adapter						
Number of vessels per adapter/rotor	30/120	26/104	21/84	16/64	16/64	1/4
Bottom shape	round	round	round		conical	flat
Centrifugation radius	190 mm	195 mm	188 mm		191 mm	143 mm
Max. RCF	$4,302 \times g$	$4,415 \times g$	$4,256 \times g$		$4,324 \times g$	$3,237 \times g$
Packing	set of 2 pcs.	set of 2 pcs.	set of 2 pcs.		set of 2 pcs.	
Order no.	5910 755.007	5910 754.000	5910 762.003		5910 752.008	

<sup>1)</sup> Please perform a manual test to determine the actual loading capacity. <sup>2)</sup> Aerosol-tight caps compatible with MTP, DWP 96 500 µl, DWP 384 200 µl. Aerosol-tight caps not compatible with DWP 96 1000 µl and 2000 µl. <sup>3)</sup> When used with aerosol-tight caps the max. capacity is reduced to 20 x 50 mL (5 x 50 mL per adapter).

50 mL conical	Microplate 96/384 wells	50 mL conical	Microplate 96/384 wells	250 mL flat, 175 – 225 mL conical	500 mL Corning®	750 mL	MTP, DWP, PCR plates
29 mm		62 mm		62 mm	96 mm	102 mm	
116 <sup>3)</sup> mm	16 mm	124 mm	16 mm	146 mm	148 mm	139 mm	88 mm
116 <sup>3)</sup> mm		121 mm		139 mm		135 mm	60 mm
9/36	1/4	7/28	1/4	1/4	1/4	1/4	5/20
conical	flat	conical	flat	flat	conical	flat	flat
192 mm	115 mm	191 mm	115 mm	187 mm	187 mm	188 mm	170 mm
$4,347 \times g$	$2,604 \times g$	$4,324 \times g$	$2,604 \times g$	$4,234 \times g$	$4,234 \times g$	$4,256 \times g$	$3,849 \times g$
set of 2 pcs.	set of 2 pcs.		set of 2 pcs.	set of 2 pcs.	set of 2 pcs.	set of 2 pcs.	set of 2 pcs.
5910 769.008	5910 769.008		5910 751.001		5910 760.000	5910 757.000	5910 753.004

## Rotors for 5910 R/5920 R

**Rotor S-4x750**

- > Medium capacity swing-bucket rotor with max. speed 4,800 × g (4,700 rpm)
- > Broad range of adapters enables high versatility for tubes and flasks from 0.2 mL to 750 mL and plates
- > Mixed loading with 2 plate buckets and 2 round tube buckets allows for increased versatility
- > Aerosol-tight QuickLock caps for safe centrifugation of hazardous samples optionally available<sup>1)</sup>
- > Buckets, caps and adapters are autoclavable

<sup>1)</sup> Aerosol-tightness tested by Public Health England, Porton Down, UK.

<b>Adapters for Rotor S-4x750</b>						
<b>Tube Volume</b>	1.5/2.0 mL	12 x 75 mm, 5 mL FACS	2.6 – 8 mL	5.5 – 12 mL	9 mL	14 mL
<b>Max. tube diameter</b>	11 mm	12 mm	13 mm	16 mm	17.5 mm	17.5 mm
<b>Max. vessel height</b>	39 mm	120 mm	121 mm	125 mm	117 mm	106 mm
<b>Max. vessel height for use with cap/lid<sup>1)</sup></b>	39 mm	113 mm	113 mm	120 mm	112 mm	106 mm
<b>Adapter</b>						
<b>Number of vessels per adapter/rotor</b>	50/200	27/108	23/92	20/80	20/80	14/56
<b>Bottom shape</b>	flat	round	round	round	round	round
<b>Centrifugation radius</b>	194 mm	186 mm	185 mm	186 mm	185 mm	185 mm
<b>Max. RCF</b>	4,800 × g	4,593 × g	4,569 × g	4,594 × g	4,569 × g	4,569 × g
<b>Packing</b>	set of 2 pcs.	set of 2 pcs.	set of 2 pcs.	set of 2 pcs.	set of 2 pcs.	set of 2 pcs.
<b>Order no.</b>	5825 740.009	5825 747.003	5825 738.004	5825 736.001	5825 743.008	5825 748.000

<sup>1)</sup> Exceeding the maximum tube length may reduce the loading capacity of the rotor. Please perform a manual swing-out test before starting the centrifuge run to make sure the tubes do not hit the rotor yoke.

<sup>2)</sup> Please note that these conical bottles need to be used together with a conical form insert provided by the manufacturer.<sup>3)</sup> 225 mL conical for S-4-104 and S-4x750, 250 mL conical for S-4x1000 with round bucket.

**Ordering information**

Description	Order no.
<b>Rotor S-4x750</b> , aerosol-tight, without buckets	5895 121.004
<b>Rotor S-4x750</b> , aerosol-tight, incl. 4 × 750 mL round buckets	5895 120.008
<b>Buckets for Rotor S-4x750</b> , Round buckets for Rotor S-4x750, set of 2 pcs.	5895 123.007
<b>Buckets for Rotor S-4x750</b> , Round buckets for Rotor S-4x750, set of 4 pcs.	5895 122.000
<b>Buckets for Rotor S-4x750</b> , Plate bucket (aerosol-tight capable), incl. plate carrier, set of 4 pcs.	5895 124.003
<b>Buckets for Rotor S-4x750</b> , Plate bucket (aerosol-tight capable), incl. plate carrier, set of 2 pcs.	5895 125.000
<b>Aerosol-tight caps for plate buckets (aerosol-tight capable)</b> , aerosol-tight, for Rotor S-4-104 and Rotor S-4x750, set of 2 pcs.	5820 748.001
<b>Aerosol-tight caps for 750 mL round buckets</b> , aerosol-tight, for Rotor S-4-104, Rotor S-4x750 and Rotor S-4x1000, set of 2 pcs.	5820 747.005
<b>Wide-neck bottle</b> , 750 mL, set of 2 pcs.	5820 708.000

<b>Eppendorf Tubes<sup>®</sup> 5.0 mL and 15 mL conical</b>								
<b>Tube Volume</b>	5.0 mL and 15 mL	30 mL	50 mL conical	50 mL conical, skirted	250 mL flat, 175 – 225/250 mL conical <sup>2) 3)</sup>	500 mL Corning <sup>®</sup>	750 mL	MTP, DWP, PCR plates
<b>Tube diameter</b>	17 mm	25 mm	31 mm	31 mm	62 mm	98 mm	104 mm	
<b>Tube height</b>	125 mm	117 mm	122 mm	122 mm	145 mm	150 mm	133 mm	60 mm
<b>Tube length</b>	120 mm	112 mm	116 mm	116 mm	125 mm		133 mm	45 mm
<b>Adapter</b>								
<b>Number of vessels per adapter/rotor</b>	14/56	8/32	7/28	5/20	1/4	1/4	1/4	4/16 (MTP) 1/4 (DWP)
<b>Bottom shape</b>	conical	flat	conical	conical	flat	conical	flat	
<b>Centrifugation radius</b>	188 mm	180 mm	187 mm	177 mm	183 mm	186 mm	185 mm	161 mm
<b>Max. RCF</b>	4,643 × g	4,445 × g	4,618 × g	4,371 × g	4,519 × g	4,594 × g	4,569 × g	3,976 × g
<b>Packing</b>	set of 2 pcs.	set of 2 pcs.	set of 2 pcs.	set of 2 pcs.	set of 2 pcs.	set of 2 pcs.	set of 2 pcs.	set of 2 pcs.
<b>Order no.</b>	5825 734.009	5825 755.006	5825 733.002	5825 732.006	5825 741.005	5825 745.000	5825 744.004	5895 125.000

## Rotors for 5910 R

**Rotor S-4x500**

- > Medium capacity swing-bucket rotor with max. speed 3,220 × g (4,000 rpm)
- > Rotor S-4x500 accommodates tubes and bottles from 0.2 mL to 500 mL as well as plates
- > Aerosol-tight caps for safe centrifugation of hazardous samples optionally available<sup>1)</sup>
- > Mixed loading with 2 plate buckets and 2 rectangular tube buckets allows for increased versatility
- > Buckets, caps and adapters are autoclavable

<sup>1)</sup> Aerosol-tightness tested by Public Health England, Porton Down, UK.

**Ordering information**

Description	Order no.
<b>Rotor S-4x500</b> , for 500 mL rectangular buckets or MTP/Flex buckets	
incl. 4 x 500 mL rectangular buckets	5895 170.005
without buckets	5895 171.001
<b>Cap for 500 mL rectangular buckets</b> , aerosol-tight, aerosol-tight, for Rotor A-4-81, set of 2 pcs.	5810 724.007

<b>Adapters for Rotor S-4x500</b>						
<b>Tube Volume</b>	1.5/2.0 mL	1.2 – 5 mL	2.6 – 5 mL	2.6 – 7 mL	3 – 15 mL	7 – 17 mL
<b>Max. tube diameter</b>	11 mm	11 mm	13 mm	13 mm	16 mm	17.5 mm
<b>Max. vessel height</b>	43 mm	118 mm	118 mm	118 mm	118 mm	118 mm
<b>Max. vessel height for use with cap/lid<sup>1)</sup></b>	43 mm	108 mm	107 mm	108 mm	108 mm	118 mm
<b>Adapter</b>						
<b>Number of vessels per adapter/rotor</b>	20/80	20/80	25/100	18/72	16/64	16/64
<b>Bottom shape</b>	flat	flat	flat with rubber mat	flat with rubber mat	flat with rubber mat	flat with rubber mat
<b>Centrifugation radius</b>	165 mm	168 mm	168 mm	168 mm	168 mm	168 mm
<b>Max. RCF</b>	2,950 × g	3,000 × g	3,000 × g	3,000 × g	3,000 × g	3,000 × g
<b>Packing</b>	set of 2 pcs.	set of 2 pcs.	set of 2 pcs.	set of 2 pcs.	set of 2 pcs.	set of 2 pcs.
<b>Order no.</b>	5810 745.004	5810 746.000	5810 720.001	5810 747.007	5810 748.003	5810 721.008

<sup>1)</sup> Please perform a manual test to determine the actual loading capacity.

Eppendorf Tubes® 5.0 mL and 15 mL conical tubes	50 mL conical	30 – 50 mL and 50 mL conical tubes, skirted	180 – 250 mL flat/175 – 225 mL conical	400 mL	500 mL	MTP, DWP, PCR plates
17.5 mm	31 mm	31/29 mm	62 mm	81 mm	83 mm	
121 mm	122 mm	121 mm	133 mm		135 mm	60 mm
119 mm	116 mm				135 mm	
12/48	5/20	5/20	1/4	1/4	-/4	4/16 (MTP) 1/4 (DWP)
conical	conical	flat with rubber mat	flat with rubber mat	flat, rubber	flat	flat with rubber mat
173 mm	173 mm	173 mm	173 mm	180 mm	180 mm	163 mm
3,100 × g	3,100 × g	3,100 × g	3,100 × g	3,220 × g	3,220 × g	2,900 × g
set of 2 pcs.	set of 2 pcs.	set of 2 pcs.	set of 2 pcs.	set of 2 pcs.		set of 2 pcs.
5810 722.004	5810 723.000	5810 739.004	5825 722.000	5810 728.002	-	5810 742.005

## Rotors for 5910 R

**Rotor S-4x400**

- > High-speed medium capacity swing-bucket rotor with max. speed 5,234 x g (5,100 rpm)
- > Broad range of adapters enables high versatility for tubes and bottles from 0.2 mL to 250 mL
- > Aerosol-tight QuickLock caps for safe centrifugation of hazardous samples optionally available<sup>1)</sup>
- > Buckets, caps and adapters are autoclavable

<sup>1)</sup> Aerosol-tightness tested by Public Health England, Porton Down, UK.

**Ordering information**

Description	Order no.
Rotor S-4x400, incl. 400 mL round bucket	5895 180.000
Aerosol-tight caps, for Rotor S-4x400, set of 2 pcs.	5910 700.008

<b>Adapters for Rotor S-4x400</b>				
<b>Tube Volume</b>	1.5 mL/2.0 mL	12 mm x 75 mm	4 mL - 8 mL	7.5 mL - 12 mL
<b>Max. tube diameter</b>	11 mm	12 mm	13 mm	16 mm
<b>Max. vessel height</b>	39 mm	188 mm	119 mm	122 mm
<b>Max. vessel height for use with cap/lid<sup>1)</sup></b>		112 mm	105 mm	115 mm
<b>Adapter</b>				
<b>Number of vessels per adapter/rotor</b>	26/104	17/68	15/60	11/44
<b>Bottom shape</b>	open	round	round	round
<b>Centrifugation radius</b>	177 mm	172 mm	171 mm	173 mm
<b>Max. RCF</b>	5,147 x g	5,002 x g	4,818 x g	4,874 x g
<b>Packing</b>	set of 2 pcs.	set of 2 pcs.	set of 2 pcs.	set of 2 pcs.
<b>Order no.</b>	5910 708.009	5910 711.000	5910 703.007	5910 704.003

<sup>1)</sup> Please perform a manual test to determine the actual loading capacity.

<b>9 mL</b>	<b>Eppendorf Tubes® 5.0 mL and 15 mL conical</b>	<b>50 mL conical</b>	<b>175 mL - 250 mL</b>
17.5 mm	17 mm	29 mm	62 mm
122 mm	133 mm	125 mm	138 mm
115 mm	126 mm	117 mm	129 mm
<b>8/32</b>	<b>7/28</b>	<b>4/16</b>	<b>1/4</b>
round	conical	conical	flat
173 mm	180 mm	179 mm	174 mm
4,874 x g	5,071 x g	5,043 x g	5,060 x g
set of 2 pcs.	set of 2 pcs.	set of 2 pcs.	set of 2 pcs.
5910 709.005	5910 702.000	5910 701.004	5910 705.000

## Rotors for 5910 R/5920 R

**Rotor FA-6x50**

- > High-speed rotor for applications in tubes from 5 – 50 mL
- > Max. speed 20,130 × g (12,100 rpm)
- > Eppendorf QuickLock rotor lid for fast lid locking
- > Aerosol-tight<sup>1)</sup> for safe centrifugation of hazardous samples
- > Low rotor weight (3.2 kg) for easy handling
- > Anodized aluminum for high chemical resistance
- > 45° borehole angle minimizes pellets smear
- > Rotor, lid and adapters are autoclavable

<sup>1)</sup> Aerosol-tightness tested by Public Health England, Porton Down, UK.

**Ordering information**

Description	Order no.
Rotor FA-6x50, aerosol-tight, incl. rotor lid	5895 150.004

<b>Adapters for Rotor FA-6x50</b>					
<b>Tube Volume</b>	2.6 – 5 mL	4 – 8 mL	5.5 – 10 mL	7.5 – 12 mL	Eppendorf Tubes® 5.0 mL
<b>Max. tube diameter</b>	13 mm	13 mm	16 mm	16 mm	17 mm
<b>Max. vessel height for use with cap/lid</b>	119 mm	119 mm	119 mm	119 mm	121 mm
<b>Adapter</b>					
<b>Number of vessels per adapter/rotor</b>	1/6	1/6	1/6	1/6	1/6 <sup>1)</sup>
<b>Bottom shape</b>	round	round	round	round	conical
<b>Centrifugation radius</b>	120 mm	120 mm	120 mm	120 mm	121 mm
<b>Max. RCF</b>	19,642 × g	19,642 × g	19,642 × g	19,642 × g	19,806 × g
<b>Packing</b>	set of 2 pcs.	set of 2 pcs.	set of 2 pcs.	set of 2 pcs.	set of 2 pcs.
<b>Order no.</b>	5820 726.008	5820 725.001	5820 728.000	5820 727.004	5820 730.005

<sup>1)</sup> Eppendorf Tubes® 5.0 mL with screw cap will not fit in this adapter.

## Eppendorf Conical Tubes

Whether centrifugation, mixing, or other applications – the Eppendorf Conical Tubes 15 mL and 50 mL will perfectly fit into your workflows. They represent the next step in Eppendorf's comprehensive system solutions in liquid, sample and cell handling.

More information: [www.eppendorf.com/conicals](http://www.eppendorf.com/conicals)

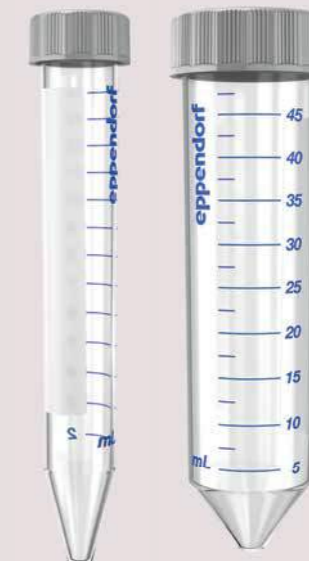

7 – 17 mL	15 mL	15 – 18 mL	20 – 30 mL	35 mL	50 mL conical
17.5 mm	17 mm	18 mm	26 mm	29 mm	31 mm
122 mm	125 mm	125 mm	125 mm	125 mm	121 mm
1/6	1/6	1/6	1/6	1/6	-/6
round	conical	round	round	conical	conical
120 mm	120 mm	120 mm	105 mm	112 mm	123 mm
19,642 × g	19,642 × g	19,642 × g	17,187 × g	18,333 × g	20,130 × g
set of 2 pcs.	set of 2 pcs.	set of 2 pcs.	set of 2 pcs.	set of 2 pcs.	-
5820 729.007	5820 717.009	5820 720.000	5820 721.006	5820 722.002	-



## Rotors for 5910 R/5920 R

**Rotor FA-20x5**

- > 20 places for Eppendorf Tubes® 5.0 mL<sup>1)</sup>
- > Max. speed: 20,913 × g (13,100 rpm)
- > Aerosol-tight<sup>2)</sup> Eppendorf QuickLock rotor lid
- > Rotor, lid and adapters are autoclavable (121 °C, 20 min)
- > Anodized aluminum for high chemical resistance

<sup>1)</sup> For Eppendorf Tubes® 5.0 mL with screw cap the capacity is limited to 10 tubes. <sup>2)</sup> Aerosol-tightness tested by Public Health England, Porton Down, UK.

**Ordering information**

Description	Order no.
<b>Rotor FA-20x5</b> , for 20 Eppendorf Tubes® 5.0 mL, incl. aerosol-tight Eppendorf QuickLock® rotor lid	5895 130.003
<b>Adapter</b> , for 1 vessel 1.5 – 2.0 mL, for Rotors FA-45-12-17, FA-45-16-17 and FA-45-20-17, set of 4 pcs.	5820 768.002
<b>Adapter</b> , for 1 cryo tube, for Rotors FA-45-12-17, FA-45-16-17 and FA-45-20-17, set of 4 pcs.	5820 769.009
<b>Adapter</b> , for 1 HPLC tube, for Rotors FA-45-12-17, FA-45-16-17 and FA-45-20-17, set of 4 pcs.	5820 770.007
<b>Adapter</b> , for 1 tube 0.5 mL, max. Ø 8 mm or microtainer 0.6 mL, max. Ø 8 mm, for all 1.5/2.0 mL rotors, set of 6 pcs.	5425 716.001
<b>Adapter</b> , for 1 tube 0.4 mL, max. Ø 6 mm, for all 1.5/2.0 mL rotors, set of 6 pcs.	5425 717.008
<b>Adapter</b> , for 1 PCR tube 0.2 mL, max. Ø 6 mm, for all 1.5/2.0 mL rotors, set of 6 pcs.	5425 715.005

**Rotor FA-48x2**

- > 48 places for 1.5/2.0 mL tubes
- > Max. speed: 21,194 × g/13,700 rpm (5920 R)/22,132 × g/14,000 rpm (5910 R)
- > Eppendorf QuickLock rotor lid for fast lid locking
- > Aerosol-tight<sup>1)</sup> for safe centrifugation of hazardous samples
- > Anodized aluminum for high chemical resistance
- > Rotor and lid are autoclavable (121 °C, 20 min)

<sup>1)</sup> Aerosol-tightness tested by Public Health England, Porton Down, UK.

**Ordering information**

Description	Order no.
<b>Rotor FA-48x2</b> , incl. aerosol-tight Eppendorf QuickLock® rotor lid	5895 135.005

## Rotors for 5910 R

**Rotor F-48x15**

- > High-capacity fixed-angle rotor for 15 mL conical and glass tubes
- > Maximum speed: 5,005 × g (5,500 rpm)
- > Form inserts for 15 mL conical tubes

**Ordering information**

Description	Order no.
<b>Rotor F-48x15</b> , for 48 mL conical tubes	
incl. 48 steel sleeves and adapters	5895 160.000

**Rotor FA-30x2**

- > 30 places for 1.5/2.0 mL tubes
- > Max. speed: 20,984 × g (max. 13,700 rpm)
- > Eppendorf QuickLock rotor lid for fast lid locking
- > Aerosol-tight for safe centrifugation of hazardous samples<sup>1)</sup>
- > Anodized aluminum for high chemical resistance
- > Rotor and lid are autoclavable (121 °C, 20 min)

<sup>1)</sup> Aerosol-tightness tested by Public Health England, Porton Down, UK.

**Ordering information**

Description	Order no.
<b>Rotor FA-30x2</b> , incl. aerosol-tight Eppendorf QuickLock® rotor lid	5895 155.006

# Concentrator plus

## Description

The Concentrator plus with its new design was designed with the customer in mind to deliver an ergonomic, intuitive and durable solution that fits comfortably right on the lab bench. An advanced heating technology provides best treatment for your sample which assures quick, efficient and gentle vacuum concentration of DNA/RNA, nucleotides, proteins and other liquid or wet samples. Our new coated lid provides superior chemical resistance against aggressive acids and organic solvents (e.g. TFA, DMSO).

The Concentrator plus is available with three configurations to meet the customers' lab specific needs:

- 1) Basic Concentrator for connecting to an existing vacuum pump
- 2) Complete system with an integrated solvent-resistant, maintenance and oil-free PTFE pump, and condensation trap
- 3) Complete system with vacuum port adds extra capability. It allows for using the integrated vacuum pump separately – without having to disconnect it from the system

## Product features

- > Comes in 3 system configurations
- > Extremely quiet operation <50 dB(A)
- > Chemical-resistant, maintenance-free PTFE diaphragm pump eliminates the need for changing pump oil
- > Small footprint saves valuable bench space
- > Wide variety of 15 different rotor options to accommodate tubes from 0.2 mL to 50 mL, microplates and PCR plates
- > Motorless induction drive and chemical-resistant, stainless steel chamber for trouble-free operation
- > Can be connected with most commercially available cold traps for use with vapors
- > Coated lid with superior chemical resistance



Technical specifications			
Model	Concentrator plus basic	Concentrator plus system	Concentrator plus system w/port
Vacuum	–	20 hPa (20 mbar)	20 hPa (20 mbar)
Fixed speed	1,400 rpm	1,400 rpm	1,400 rpm
Tube volume	0.2 – 50 mL	0.2 – 50 mL	0.2 – 50 mL
Sample capacity	max. 144 vessels/2 microplates	max. 144 vessels/2 microplates	max. 144 vessels/2 microplates
Port to connect external devices to vacuum pump	no	no	yes
Max. power consumption	150 W	350 W	350 W
Dimensions (W x D x H)	33 x 37 x 23 cm	33 x 58 x 29 cm	33 x 58 x 29 cm
Weight w/o accessories	16.5 kg	31.5 kg	31.5 kg



## Concentrator junction system

The complete "junction" system adds extra capability/flexibility. It allows you to use the integrated vacuum pump separately – without having to disconnect it from the system; simply connect the port to any external device that requires vacuum (e.g. gel dryer).

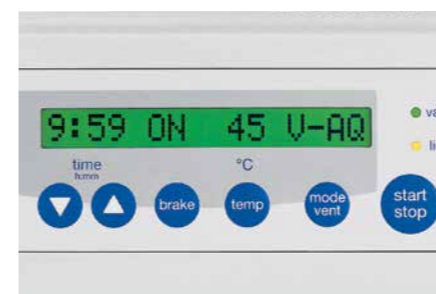

## Key function

- > Timer selection between 1 min and 9:59 as well as Brake function
- > Temperature preselection: room temperature, 30 °C, 45 °C and 60 °C
- > Mode/vent function: choose between three solvent modes
- > Start/Stop of concentration process

## Ordering information

Description	Order no.
<b>Concentrator plus basic device</b>	
230 V/50 – 60 Hz, with Rotor F-45-48-11	5305 000.100
<b>Concentrator plus complete system</b>	
230 V/50 – 60 Hz, with integrated diaphragm vacuum pump, with Rotor F-45-48-11	5305 000.304
230 V/50 – 60 Hz, with integrated diaphragm vacuum pump, without rotor	5305 000.509
230 V/50 – 60 Hz, with integrated diaphragm vacuum pump; with connection, e.g., for a gel dryer; without rotor	5305 000.703
<b>Adapter</b> , for 1 tube 0.5 mL, max. Ø 6 mm or microtainer 0.6 mL, max. Ø 8 mm, for all 1.5/2.0 mL rotors, set of 6 pcs.	5425 716.001
<b>Adapter</b> , for 1 PCR tube 0.2 mL, max. Ø 6 mm, for all 1.5/2.0 mL rotors, set of 6 pcs.	5425 715.005
<b>CombiSlide Adapter</b> , for 12 slides Combi Slide 12 slides, for plate rotors, set of 2 pcs.	5825 706.005
<b>Adapter</b> , for 1 PCR tube 0.2 mL, for Rotor F-45-72-8, set of 6 pcs.	5425 723.008
<b>Rotor spacer</b> , required for stacking rotors F-45-72-8 and F-45-48-11	5301 316.005
<b>Work tray</b> , for semi-/unskirted PCR plates, PCR strips and 0.2 mL PCR tubes, for Rotor A-2-VC, set of 10 pcs.	0030 124.235
<b>Frame for work tray</b> , for Rotor A-2-VC, set of 5 pcs.	0030 124.243

✎ Ordering information for other voltage options begins on page 434





[www.eppendorf.com/concentrator-brochure](http://www.eppendorf.com/concentrator-brochure)

For more information go to [www.eppendorf.com/centrifugation](http://www.eppendorf.com/centrifugation)

## Rotors for Concentrator plus

## Ordering information

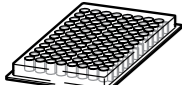
	Description	Max. tube dimensions Ø x L	Sample capacity	Order no.
	Rotor F-45-72-8	8 x 31 mm <sup>1)</sup>	72 x 0.5 mL	5490 034.007
	Rotor F-45-70-11	11 x 41/47 mm	70 x 1.5 mL, 70 x 2.0 mL	5490 032.004
	Rotor F-45-48-11	11 x 41/47 mm <sup>1)</sup>	48 x 1.5 mL / 2.0 mL	5490 030.001
	Rotor F-40-36-12	12 x 32 mm	36 x 1.5 mL	5490 040.007
	Rotor F-45-36-15	15 x 45 – 48 mm <sup>2)</sup>	36 x 3.0/5.0 mL	5490 035.003
	Rotor F-45-16-20	20 x 42 – 55 mm <sup>2)</sup>	16 x 6.5/10 mL	5490 043.006
	Rotor F-40-18-19	19 x 66 mm	18 x 10 mL	5490 037.006
	Rotor F-45-12-31	31 x 55 mm	12 x 20 mL	5490 044.002
	Rotor F-35-8-24	24 x 86 – 105 mm <sup>2)</sup>	8 x 25 mL	5490 039.009
	Rotor F-45-24-12	12 x 67 – 100 mm <sup>2) 3)</sup>	24 x 5 – 7 mL	5490 036.000
	Rotor F-50-8-16	16 x 105 – 120 mm <sup>2)</sup>	8 x 8 – 12 mL	5490 041.003
	Rotor F-50-8-18	18 x 105 – 128 mm <sup>2)</sup>	8 x 10 – 18 mL	5490 042.000
	Rotor F-45-8-17	17 x 116 – 123 mm <sup>2)</sup>	8 x 15 mL conical tubes	5490 038.002
	Rotor F-35-6-30	17 x 116 – 123 mm or 30 x 116 – 123 mm <sup>2)</sup>	6 x 15 mL conical tubes or 6 x 50 mL conical tubes	5490 047.001
	Rotor A-2-VC	128 x 86 x 27 mm	2 x MTP or skirted PCR plates 2 x Deepwell plates (DWP) (max. height = 27 mm)	5490 045.009

<sup>1)</sup> Rotor is stackable for double capacity using spacer 5301 316.005. <sup>2)</sup> Min./max. tube length. <sup>3)</sup> Tube length = 75 mm: max capacity 24 tubes, tube length > 75 mm: max capacity 12 tubes.

**Rotor F-45-48-11**

- > Rotor for 48 x 1.5/2.0 mL microcentrifuge tubes
- > A spacer enables additional stacking (double capacity)

**Rotor F-35-6-30**

- > Rotor for 6 x 50 mL conical tubes
- > Also accommodates 6 x 15 mL conical tubes

**Rotor A-2-VC**

- > For use with MTP, PCR and Deepwell Plates up to 27 mm high
- > A work tray with frame is available for PCR test plates and microplates without frames
- > Rotor can be autoclaved for 20 min. at 121°C
- > Suitable for the CombiSlide Adapter

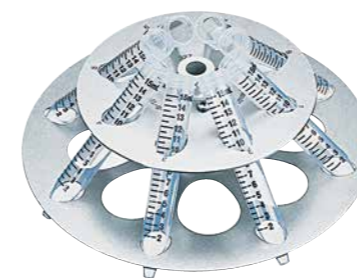
**Rotor F-45-8-17**

- > Rotor for 8 x 15 mL conical tubes

# Sample Handling



Model	Eppendorf BioPhotometer® D30	Eppendorf BioSpectrometer® basic
Page(s)	216	217
Wavelength range absorption	230, 260, 280, 320, 340, 405, 490, 562, 595, 600 nm	Scan (nm): 200 – 830 at 1 nm increments
Wavelength Selection Increment	N/A	1 nm
Scanning	no	yes
Spectral bandwidth	≤4 nm	≤4 nm
Systematic error wavelength	≤0.5 nm	≤0.5 nm
Random error wavelength	±1 nm	±1 nm
Absorption measuring range	0 A – 3.0 A (260 nm)	0 A – 3.0 A (260 nm)
Systematic error absorption	±1 % (A = 1)	±1 % (A = 1)
Random error absorption	≤0.002 at A = 0 ≤0.005 (0.5 %) at A = 1	≤0.002 at A = 0 ≤0.005 (0.5 %) at A = 1
Light source absorption	Xenon flash lamp	Xenon flash lamp
Detector Type	CMOS photodiodes	CMOS photodiode array, 1,024 pixel
Measuring principle absorption	Single-beam absorption photometer with reference beam	Single-beam absorption spectrophotometer with reference beam
Light path height	8.5 mm	8.5 mm
Light source fluorescence	–	–
Beam receiver fluorescence	N/A	N/A
Measuring principle fluorescence	–	–
Fluorescence measuring range	–	–
dsDNA concentration range	2.5 ng/μL – 1,500 ng/μL	2.5 ng/μL – 1,500 ng/μL
BSA concentration range	7.5 ng/μL – 45,000 μg/μL	7.5 ng/μL – 45,000 μg/μL
Operator guidance language	Spanish, Italian, French, English, German, Japanese	Spanish, Italian, French, English, German, Japanese
Method memory	>100 method programs	>100 method programs
Dimensions (W x D x H)	295 x 400 x 150 mm / 11.6 x 15.7 x 6 in	295 x 400 x 150 mm / 11.6 x 15.7 x 6 in
Weight w/o accessories	5.4 kg	5.4 kg
Cuvette shaft	12.5 mm x 12.5 mm	12.5 mm x 12.5 mm
Power supply	100 – 240 V, 50 – 60 Hz	100 – 240 V, 50 – 60 Hz
Power consumption	Approx. 15 W during operating step Approx. 5 W with dimmed display	Approx. 15 W during operating step Approx. 5 W with dimmed display
Interfaces	<ul style="list-style-type: none"> <li>&gt; USB master: for USB stick and thermal printer DPU-S445</li> <li>&gt; USB slave for connecting to a PC (All functions available without PC)</li> <li>&gt; Serial interface RS-232: for thermal printer DPU-414</li> <li>&gt; Ethernet interface RJ45: For connecting to a network printer or emailing data outputs directly off instrument</li> </ul>	<ul style="list-style-type: none"> <li>&gt; USB master: for USB stick and thermal printer DPU-S445</li> <li>&gt; USB slave for connecting to a PC (All functions available without PC)</li> <li>&gt; Serial interface RS-232: for thermal printer DPU-414</li> <li>&gt; Ethernet interface RJ45: For connecting to a network printer or emailing data outputs directly off instrument</li> </ul>

i For more information go to [www.eppendorf.com](http://www.eppendorf.com)

Technical specifications subject to change.



Model	Eppendorf BioSpectrometer® kinetic	Eppendorf BioSpectrometer® fluorescence
Page(s)	218	218
Wavelength range absorption	Scan (nm): 200 – 830 at 1 nm increments	Scan (nm): 200 – 830 at 1 nm increments
Wavelength Selection Increment	1 nm	1 nm
Scanning	yes	yes
Spectral bandwidth	≤4 nm	≤4 nm
Systematic error wavelength	≤0.5 nm	≤0.5 nm
Random error wavelength	±1 nm	±1 nm
Absorption measuring range	0 A – 3.0 A (260 nm)	0 A – 3.0 A (260 nm)
Systematic error absorption	±1 % (A = 1)	–
Random error absorption	≤0.002 at A = 0 ≤0.005 (0.5 %) at A = 1	≤0.002 at A = 0 ≤0.005 (0.5 %) at A = 1
Light source absorption	Xenon flash lamp	Xenon flash lamp
Detector Type	CMOS photodiode array, 1,024 pixel	CMOS photodiode array, 1,024 pixel
Measuring principle absorption	Single-beam absorption spectrophotometer with reference beam	Single-beam absorption spectrophotometer with reference beam
Light path height	8.5 mm	8.5 mm
Light source fluorescence	–	LED
Beam receiver fluorescence	N/A	Photodiodes
Measuring principle fluorescence	–	Confocal filter fluorometer with reference beam
Fluorescence measuring range	–	0.5 nM – 2,000 nM fluorescein (emission wavelength 520 nm)
dsDNA concentration range	2.5 ng/μL – 1,500 ng/μL	1.0 pg/μL – 1,500 ng/μL
BSA concentration range	7.5 ng/μL – 45,000 μg/μL	0.01 ng/μL – 45,000 μg/μL
Operator guidance language	Spanish, Italian, French, English, German, Japanese	Spanish, Italian, French, English, German, Japanese
Method memory	>100 method programs	>100 method programs
Dimensions (W x D x H)	295 x 400 x 150 mm / 11.6 x 15.7 x 6 in	295 x 400 x 150 mm / 11.6 x 15.7 x 6 in
Weight w/o accessories	5.5 kg	5.4 kg
Cuvette shaft	12.5 mm x 12.5 mm, tempered 20 °C – 42 °C	12.5 mm x 12.5 mm
Power supply	100 – 240 V, 50 – 60 Hz	100 – 240 V, 50 – 60 Hz
Power consumption	Approx. 30 W during operating step Approx. 5 W with dimmed display and temperature control switched off	Approx. 15 W during operating step Approx. 5 W with dimmed display
Interfaces	<ul style="list-style-type: none"> <li>&gt; USB master: for USB stick and thermal printer DPU-S445</li> <li>&gt; USB slave for connecting to a PC (All functions available without PC)</li> <li>&gt; Serial interface RS-232: for thermal printer DPU-414</li> <li>&gt; Ethernet interface RJ45: For connecting to a network printer or emailing data outputs directly off instrument</li> </ul>	<ul style="list-style-type: none"> <li>&gt; USB master: for USB stick and thermal printer DPU-S445</li> <li>&gt; USB slave for connecting to a PC (All functions available without PC)</li> <li>&gt; Serial interface RS-232: for thermal printer DPU-414</li> <li>&gt; Ethernet interface RJ45: For connecting to a network printer or emailing data outputs directly off instrument</li> </ul>

**epServices**  
for premium performance

On page 376 you will find detailed information on services for these products!

Your local distributor: [www.eppendorf.com/contact](http://www.eppendorf.com/contact)

Eppendorf AG · Barkhausenweg 1 · 22339 Hamburg · Germany · [eppendorf@eppendorf.com](mailto:eppendorf@eppendorf.com) · [www.eppendorf.com](http://www.eppendorf.com)

# Eppendorf BioPhotometer® D30

## Description

The Eppendorf BioPhotometer D30 is the 3rd generation of Eppendorf spectrophotometers to become an established standard in the life sciences. Routine pre-defined wavelengths are easily selectable, allowing for quick and simple programming. Users are guided through every step of the assay with short, simple on-screen instructions. The ultra-stable Xenon flash lamp doesn't require any warm up time and a measurement typically takes 5 seconds. Raw and processed data are clearly presented on the large color screen and can be exported directly from the instrument in a variety of common formats. Eppendorf disposable UVettes enable measurements with as little as 50 µL of sample and the Eppendorf µCuvette G1.0 reduces this further to 1.5 µL of sample.



## Product features

- > Absorption measurements for one or more fixed wavelengths
- > Scan for specific UV applications with automatically determined purity ratios
- > Preprogrammed applications for quick start and applications with evaluation via factor, standard or standard series
- > Integrated application and results memory
- > Data transfer via USB interface, Ethernet or via e-mail and direct printout of results
- > Data output via JPEG screenshots, Microsoft Excel or secure PDF files to a standard USB flash drive or via email
- > Guided software process to minimize errors
- > Compatible with semi-micro and micro-volume measuring cells as well as standard cuvettes
- > Utilizes fixed wavelengths, irrelevant of path length
- > Integrated self-test and calibration history



[www.eppendorf.com/appnote279](http://www.eppendorf.com/appnote279)

## Applications

- > Nucleic acid quantification
- > Direct protein quantification (UV 280 nm)
- > Microvolume measurement via µCuvette G1.0 for highly concentrated samples
- > Bacteria growth measurement (OD 600)
- > Colorimetric assays for protein quantification, e.g., BCA, Bradford, Lowry
- > 340 nm: assays using NADPH or NAPH
- > 405 nm: assays using para-nitrophenol
- > 490 nm: cytotoxicity assay

## Ordering information

Description	Order no.
Eppendorf BioPhotometer® D30, 230 V/50 – 60 Hz	6133 000.001
Eppendorf µCuvette® G1.0 and Eppendorf BioPhotometer® D30, 230 V/50 – 60 Hz	6133 000.907
Eppendorf BioPhotometer® D30 Reference Filter Set, filter set for verifying photometric accuracy and wavelength systematic error (according to NIST®)	6133 928.004
Thermal Printer DPU-S445	6135 011.000

✎ Ordering information for other voltage options begins on page 434



[www.eppendorf.com/D30-Poster](http://www.eppendorf.com/D30-Poster)

i For more information go to [www.eppendorf.com/photometry](http://www.eppendorf.com/photometry)

# Eppendorf BioSpectrometer® basic

## Description

Building on the legacy of the Eppendorf BioPhotometer D30, the Eppendorf BioSpectrometer basic shares its simplicity, flexibility and reliability. In addition to the Biophotometer D30, the Biospectrometer basic has freely selectable wavelengths from 200 – 830 nm (selectable in 1nm increments). This allows the user to define the parameters of each assay, whether it be a scan, a single-wavelength measurement or a multi-wavelength measurement. The Eppendorf BioSpectrometer basic caters to more disciplines as the wavelengths are not pre-defined and allows for non-routine assays or new assays to be easily programmed (in addition to the pre-programmed routine methods). The Eppendorf BioSpectrometer basic is a robust yet flexible 'workhorse'.



## Product features

- > Absorbance measurement for one or more wavelengths, recording of wavelength scans from 200 nm to 830 nm (increment: 1 nm)
- > Automatic evaluation and storage of measurement data with clear presentation of results
- > Spectral graph to display sample purity with automatic ratio calculation
- > Freely programmable applications with evaluation via factor, standard or standard series and freely programmable parameters
- > Two-wavelength method with subtraction or division evaluation
- > Integrated application and results memory
- > Data transfer via USB interface, Ethernet or via e-mail and direct printout of results
- > Guided software process to minimize errors
- > Integrated self-test and calibration history

## Applications

- > Nucleic acid quantification
- > Direct protein quantification (UV 280 nm)
- > Microvolume measurement via µCuvette G1.0 for highly concentrated samples
- > Bacteria growth measurement (OD 600)
- > Colorimetric assays for protein quantification, e.g., BCA, Bradford, Lowry
- > Evaluation of FOI for dye-labeled biomolecules (nucleic acid or proteins)
- > Free selectable wavelengths, e.g., 340 nm: assays using NADPH or NAPH, 405 nm: assays using para-nitrophenol, 420 nm: assays using ortho-nitrophenol, 490 nm: colorimetric fructose determination, 490 nm: cytotoxicity assay

## Ordering information

Description	Order no.
Eppendorf BioSpectrometer® basic, 230 V/50 – 60 Hz	6135 000.009
Eppendorf µCuvette® G1.0 and Eppendorf BioSpectrometer® basic, 230 V/50 – 60 Hz	6135 000.904
Eppendorf BioSpectrometer® Reference Filter Set, filter set for verifying photometric accuracy and wavelength systematic error (according to NIST®)	6135 928.001
Thermal Printer DPU-S445	6135 011.000

✎ Ordering information for other voltage options begins on page 434

## Eppendorf BioSpectrometer® kinetic

### Description

The Eppendorf BioSpectrometer kinetic is an expansion of the Eppendorf BioSpectrometer basic and offers preprogrammed and freely programmable timed and temperature controlled assays. It features an integrated heated cuvette shaft. Its integrated Peltier element guarantees high-precision for determining enzyme and substrate kinetics as well as other temperature-sensitive applications. Guided software is included; minimal effort is required to set up new assays. Retrospective modification of the time window for regression analysis can be made directly on the device. The Biospectrometer kinetic replaces the traditional large cumbersome setup required for temperature controlled timed assays.



### Product features

- > All Eppendorf BioSpectrometer basic options
- > Integrated temperature-controlled cuvette shaft (adjustment range +20 °C to +42 °C in 0.1 °C increments)
- > Integrated interval timer (minimum interval 5 s, maximum measuring time range 59 m 59 s)
- > Preprogrammed and freely programmable kinetic methods
- > Retrospective modification of the time window for regression analysis
- > Data output via JPEG screenshots, Microsoft Excel or secure PDF files to a standard USB flash drive or via email

### Applications

- > All Eppendorf BioSpectrometer basic applications
- > Additional kinetic applications, and enzyme activity testings at different temperatures e.g.:
- > Activation of glucose via hexokinase (340 nm, 37 °C)
- > Substrate concentration of ATP (340 nm, 37 °C)
- > Enzymatic assay of  $\beta$ -galactosidase (420 nm, 30 °C)



[www.eppendorf.com/appnote370](http://www.eppendorf.com/appnote370)

### Ordering information

Description	Order no.
Eppendorf BioSpectrometer® kinetic, 230 V/50 – 60 Hz	6136 000.002
Eppendorf $\mu$ Cuvette® G1.0 and Eppendorf BioSpectrometer® kinetic, 230 V/50 – 60 Hz	6136 000.800
Eppendorf BioSpectrometer® Reference Filter Set, filter set for verifying photometric accuracy and wavelength systematic error (according to NIST®)	6135 928.001
Thermal Printer DPU-S445	6135 011.000

✂ Ordering information for other voltage options begins on page 434

i For more information go to [www.eppendorf.com/photometry](http://www.eppendorf.com/photometry)

## Eppendorf BioSpectrometer® fluorescence

### Description

The Eppendorf BioSpectrometer fluorescence is an expansion of the Eppendorf BioSpectrometer basic and features an integrated fluorescence module. UV/Vis assays, fluorescence assays and semi-micro/micro-volume measurements can all be carried out on a single instrument without the need for external control (PC/Laptop). Eppendorf BioSpectrometer fluorescence can be used to increase the measuring range for biomolecules (nucleic acids and proteins) by a factor of 1,000, compared to UV measurements. Pre-programmed (modified) methods for Qubit DNA quantification kits (SS, HS, BR) expand the flexibility and functionality of the instrument. Additionally, the use of the Eppendorf  $\mu$ Cuvette G1.0 for fluorescence assays (5  $\mu$ L loading volume) allows for a vast reduction in reagent usage.



### Product features

- > All Eppendorf BioSpectrometer basic options
- > Preprogrammed and freely programmable fluorescence methods
- > Preprogrammed (modified) methods for Qubit DNA quantification kits (SS, HS, BR)
- > Fluorescence measurement concentration of dsDNA down to 1 pg/ $\mu$ L, using Pico Green®
- > Fluorescence measurement concentration of BSA down to 0.01 ng/ $\mu$ L
- > Fluorescence excitation wavelength 470 nm, emission wavelengths 520 nm and 560 nm
- > Fluorescence intensity across a range of 0.5 nM to 2,000 nM fluorescein
- > Single consumable (UVVette) for UV/Vis and fluorescence assays

### Applications

- > Ideal for NGS applications (micro-volume UV/Vis and fluorescence assays in a single instrument)
- > dsDNA quantification down to 1 pg/ $\mu$ L with common kits, e.g., Pico Green®
- > ssDNA quantification down to 10 pg/ $\mu$ L
- > RNA quantification down to 20 pg/ $\mu$ L
- > Oligo quantification down to 10 pg/ $\mu$ L
- > Protein (BSA) quantification down to 0.01 ng/ $\mu$ L
- > Quantification of GFP-binding proteins
- > Growth measurement of GFP-binding bacteria



[www.eppendorf.com/appnote271](http://www.eppendorf.com/appnote271)

[www.eppendorf.com/biospectrometer-fluorescence-video](http://www.eppendorf.com/biospectrometer-fluorescence-video)

### Ordering information

Description	Order no.
Eppendorf BioSpectrometer® fluorescence, 230 V/50 – 60 Hz	6137 000.006
Eppendorf $\mu$ Cuvette® G1.0 and Eppendorf BioSpectrometer® fluorescence, 230 V/50 – 60 Hz	6137 000.901
Eppendorf BioSpectrometer® fluorescence Reference Filter Set, filter set for verifying photometric accuracy and wavelength systematic error (according to NIST®) and verifying fluorimetric precision (random error) and linearity	6137 928.009
Thermal Printer DPU-S445	6135 011.000

✂ Ordering information for other voltage options begins on page 434



Technical specifications		
Model	Eppendorf BioPhotometer® D30	Eppendorf BioSpectrometer® basic
Wavelength range absorption	Fixed wavelength (nm): 230, 260, 280, 320, 340, 405, 490, 562, 595, 600	Scan (nm): 200 – 830 at 1 nm increments
Absorption measuring range	0 A – 3.0 A (260 nm)	0 A – 3.0 A (260 nm)
Random error absorption	≤0.002 at A = 0 ≤0.005 (0.5 %) at A = 1	≤0.002 at A = 0 ≤0.005 (0.5 %) at A = 1
dsDNA concentration range (UV 260 nm) $\mu$ Cuvette G1.0	25 ng/ $\mu$ L – 1,500 ng/ $\mu$ L ±1 ng/ $\mu$ L at A = 0 ±2.5 ng/ $\mu$ L at A = 1 (0.5 %)	25 ng/ $\mu$ L – 1,500 ng/ $\mu$ L ±1 ng/ $\mu$ L at A = 0 ±2.5 ng/ $\mu$ L at A = 1 (0.5 %)
dsDNA concentration range (UV 260 nm) UVette 2 mm	12.5 ng/ $\mu$ L – 750 ng/ $\mu$ L ±0.5 ng/ $\mu$ L at A = 0 ±1.25 ng/ $\mu$ L at A = 1 (0.5 %)	12.5 ng/ $\mu$ L – 750 ng/ $\mu$ L ±0.5 ng/ $\mu$ L at A = 0 ±1.25 ng/ $\mu$ L at A = 1 (0.5 %)
dsDNA concentration range (UV 260 nm) UVette 10 mm	2.5 ng/ $\mu$ L – 150 ng/ $\mu$ L ±0.1 ng/ $\mu$ L at A = 0 ±0.25 ng/ $\mu$ L at A = 1 (0.5 %)	2.5 ng/ $\mu$ L – 150 ng/ $\mu$ L ±0.1 ng/ $\mu$ L at A = 0 ±0.25 ng/ $\mu$ L at A = 1 (0.5 %)
BSA concentration range (UV 280 nm) $\mu$ Cuvette G1.0	75 ng/ $\mu$ L – 45,000 $\mu$ g/ $\mu$ L ±0.03 $\mu$ g/ $\mu$ L at A = 0 ±0.076 $\mu$ g/ $\mu$ L at A = 1 (0.5 %)	75 ng/ $\mu$ L – 45,000 $\mu$ g/ $\mu$ L ±0.03 $\mu$ g/ $\mu$ L at A = 0 ±0.076 $\mu$ g/ $\mu$ L at A = 1 (0.5 %)
BSA concentration range (UV 280 nm) UVette 2 mm	37.5 ng/ $\mu$ L – 22,500 $\mu$ g/ $\mu$ L ±0.015 $\mu$ g/ $\mu$ L at A = 0 ±0.038 $\mu$ g/ $\mu$ L at A = 1 (0.5 %)	37.5 ng/ $\mu$ L – 22,500 $\mu$ g/ $\mu$ L ±0.015 $\mu$ g/ $\mu$ L at A = 0 ±0.038 $\mu$ g/ $\mu$ L at A = 1 (0.5 %)
BSA concentration range (UV 280 nm) UVette 10 mm	7.5 ng/ $\mu$ L – 4,500 $\mu$ g/ $\mu$ L ±0.003 $\mu$ g/ $\mu$ L at A = 0 ±0.007 $\mu$ g/ $\mu$ L at A = 1 (0.5 %)	7.5 ng/ $\mu$ L – 4,500 $\mu$ g/ $\mu$ L ±0.003 $\mu$ g/ $\mu$ L at A = 0 ±0.007 $\mu$ g/ $\mu$ L at A = 1 (0.5 %)
Adjustable temperature range	–	–
Systematic temperature error	–	–
Random temperature error	–	–
Measuring time range	–	–
Interval between two measuring points	–	–
BSA concentration range	7.5 ng/ $\mu$ L – 45,000 $\mu$ g/ $\mu$ L	7.5 ng/ $\mu$ L – 45,000 $\mu$ g/ $\mu$ L
Light source absorption	Xenon flash lamp	Xenon flash lamp
Light source fluorescence	–	–
Measuring principle fluorescence	–	–
Excitation wavelength fluorescence	–	–
Emission wavelength I fluorescence	–	–
Emission wavelength II fluorescence	–	–
Fluorescence measuring range	–	–
Random error fluorescence	–	–

Technical specifications		
Model	Eppendorf BioSpectrometer® kinetic	Eppendorf BioSpectrometer® fluorescence
Wavelength range absorption	Scan (nm): 200 – 830 at 1 nm increments	Scan (nm): 200 – 830 at 1 nm increments
Absorption measuring range	0 A – 3.0 A (260 nm)	0 A – 3.0 A (260 nm)
Random error absorption	≤0.002 at A = 0 ≤0.005 (0.5 %) at A = 1	≤0.002 at A = 0 ≤0.005 (0.5 %) at A = 1
dsDNA concentration range (UV 260 nm) $\mu$ Cuvette G1.0	25 ng/ $\mu$ L – 1,500 ng/ $\mu$ L ±1 ng/ $\mu$ L at A = 0 ±2.5 ng/ $\mu$ L at A = 1 (0.5 %)	25 ng/ $\mu$ L – 1,500 ng/ $\mu$ L ±1 ng/ $\mu$ L at A = 0 ±2.5 ng/ $\mu$ L at A = 1 (0.5 %)
dsDNA concentration range (UV 260 nm) UVette 2 mm	12.5 ng/ $\mu$ L – 750 ng/ $\mu$ L ±0.5 ng/ $\mu$ L at A = 0 ±1.25 ng/ $\mu$ L at A = 1 (0.5 %)	12.5 ng/ $\mu$ L – 750 ng/ $\mu$ L ±0.5 ng/ $\mu$ L at A = 0 ±1.25 ng/ $\mu$ L at A = 1 (0.5 %)
dsDNA concentration range (UV 260 nm) UVette 10 mm	2.5 ng/ $\mu$ L – 150 ng/ $\mu$ L ±0.1 ng/ $\mu$ L at A = 0 ±0.25 ng/ $\mu$ L at A = 1 (0.5 %)	2.5 ng/ $\mu$ L – 150 ng/ $\mu$ L ±0.1 ng/ $\mu$ L at A = 0 ±0.25 ng/ $\mu$ L at A = 1 (0.5 %)
BSA concentration range (UV 280 nm) $\mu$ Cuvette G1.0	75 ng/ $\mu$ L – 45,000 $\mu$ g/ $\mu$ L ±0.03 $\mu$ g/ $\mu$ L at A = 0 ±0.076 $\mu$ g/ $\mu$ L at A = 1 (0.5 %)	75 ng/ $\mu$ L – 45,000 $\mu$ g/ $\mu$ L ±0.03 $\mu$ g/ $\mu$ L at A = 0 ±0.076 $\mu$ g/ $\mu$ L at A = 1 (0.5 %)
BSA concentration range (UV 280 nm) UVette 2 mm	37.5 ng/ $\mu$ L – 22,500 $\mu$ g/ $\mu$ L ±0.015 $\mu$ g/ $\mu$ L at A = 0 ±0.038 $\mu$ g/ $\mu$ L at A = 1 (0.5 %)	37.5 ng/ $\mu$ L – 22,500 $\mu$ g/ $\mu$ L ±0.015 $\mu$ g/ $\mu$ L at A = 0 ±0.038 $\mu$ g/ $\mu$ L at A = 1 (0.5 %)
BSA concentration range (UV 280 nm) UVette 10 mm	7.5 ng/ $\mu$ L – 4,500 $\mu$ g/ $\mu$ L ±0.003 $\mu$ g/ $\mu$ L at A = 0 ±0.007 $\mu$ g/ $\mu$ L at A = 1 (0.5 %)	7.5 ng/ $\mu$ L – 4,500 $\mu$ g/ $\mu$ L ±0.003 $\mu$ g/ $\mu$ L at A = 0 ±0.007 $\mu$ g/ $\mu$ L at A = 1 (0.5 %)
Adjustable temperature range	20 – 42 °C (smallest step size 0.1 °C)	–
Systematic temperature error	±0.2 °C at 25 – 37 °C	–
Random temperature error	±0.15 °C at 25 – 37 °C	–
Measuring time range	00:05 – 59:59 min:sec	–
Interval between two measuring points	00:05 – 10:00 min:sec	–
BSA concentration range	7.5 ng/ $\mu$ L – 45,000 $\mu$ g/ $\mu$ L	0.01 ng/ $\mu$ L – 45,000 $\mu$ g/ $\mu$ L
Light source absorption	Xenon flash lamp	Xenon flash lamp
Light source fluorescence	–	LED
Measuring principle fluorescence	–	Confocal filter fluorometer with reference beam
Excitation wavelength fluorescence	–	470 nm, bandwidth: 25 nm
Emission wavelength I fluorescence	–	520 nm, bandwidth: 15 nm
Emission wavelength II fluorescence	–	560 nm, bandwidth: 40 nm
Fluorescence measuring range	–	0.5 nM – 2,000 nM fluorescein (emission wavelength 520 nm)
Random error fluorescence	–	±2 % at 1 nM fluorescein



Model	Eppendorf μCuvette® G1.0	UVette®	Macro Vis Cuvette	Semi-micro Vis Cuvette
Page(s)	223	224	225	225
dsDNA concentration range	25 ng/μL – 1,500 ng/μL	2.5 ng/μL – 750 ng/μL	–	–
BSA concentration range	75 ng/μL – 45,000 ng/μL	7.5 ng/μL – 22,500 ng/μL	–	–
Colorimetric protein assays	yes	yes	yes	yes
OD 600 methods	no	yes	yes	yes
Fluorescence measurements	yes	yes	yes	yes
UV transparency	>180 nm	>220 nm	–	–
Light transmission	180 nm – 2,000 nm	220 nm – 1,600 nm	300 nm – 900 nm	300 nm – 900 nm
Material				
Dimensions (W x D x H)	12.5 x 12.5 x 48 mm	12.5 x 12.5 x 36 mm	12.5 x 12.5 x 45 mm	12.5 x 12.5 x 45 mm
Temperature control	no	no	yes	no
Minimum filling volume				
in Eppendorf photometers	1.5 μL	50 μL	1,000 μL	400 μL
in devices of other manufacturers	–	50 μL	2,500 μL	1,500 μL
Maximum filling volume	10 μL	2,000 μL	4,500 μL	3,000 μL
Light path height	1 mm	2 mm and 10 mm	10 mm	10 mm
Cuvette blank	≤0.05 A at 260 nm	≤0.05 A at 260 nm	–	–
Height of light source	8.5 mm	8.5 <sup>1)</sup> mm	8.5 mm – 15 mm	8.5 mm – 15 mm
Use in Eppendorf BioPhotometer	yes	yes	yes	yes
Use in Eppendorf BioSpectrometer	yes	yes	yes	yes
Use in devices of other manufacturers	no	yes (adapters available)	yes	yes

<sup>1)</sup> (adapters available for height adjustment)

## Eppendorf μCuvette® G1.0

### Description

The Eppendorf μCuvette G1.0 microvolume measuring cell is a high-quality cuvette made of aluminum and quartz glass. It is the perfect tool for measuring high concentrations in small volumes. With a fixed optical path length of only 1 mm, the μCuvette G1.0 features a light path that is ten times shorter than in standard cuvettes. This allows nucleic acid and protein concentrations to be measured with high reproducibility in a much higher concentration range without prior dilution. Due to the hydrophobic coating on the quartz glass only 1.5 μL nucleic acid or 3 μL protein sample are required for precise formation of the liquid column. Self-absorption of the μCuvette G1.0 is very low, meaning that the entire measuring range of the photometer can be used. Furthermore, 5 μL of sample solution can be used for specific fluorometric assays saving reagent.



### Product features

- > Microvolume measuring cell for measuring 1.5 – 10 μL sample volumes
- > Concentration determination of nucleic acids and proteins, amongst other target analytes
- > Measurement of highly concentrated samples without prior dilution
- > Suitable for fluorescence assays
- > Low self-absorption (≤0.05 A at 260 nm)
- > Hydrophobic surface coating on quartz glass for precise formation and positioning of the sample volume
- > Simple cleaning to minimize the risk of sample carry-over
- > A defined angle for folding the sides of the cuvette guarantees reproducible handling
- > One-component hinged design prevents the loss of individual parts
- > Exclusively available for use with Eppendorf BioPhotometer and Eppendorf BioSpectrometer

### Ordering information

Description	Order no.
Eppendorf μCuvette® G1.0, Microvolume measuring cell for Eppendorf BioPhotometer and BioSpectrometer	6138 000.018

✂ Ordering information for other voltage options begins on page 434

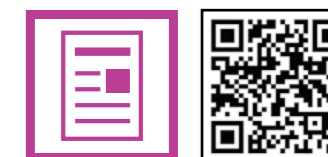

www.eppendorf.com/appnote261



## UVette®

### Description

The Eppendorf UVette allows for measurements in the UV/Vis range with transparency from 220 nm to 1,600 nm with just a typical minimum volume of 50 µL. The UVette allows the user to choose between two optical path lengths (10 mm and 2 mm). The path length can be reduced by a factor of x5 without diluting or wasting any sample – simply by turning the UVette 90°. The UVette is suitable for fluorescence assays due to its low auto-fluorescence. The PCR-clean and protein-free individually sealed variant is ideal for accurate nucleic acid and protein quantification. The UVette is ideally matched for use with the Eppendorf BioPhotometer and Eppendorf BioSpectrometer families. The UVette can be used in other spectrophotometers with the aid of an adapter.

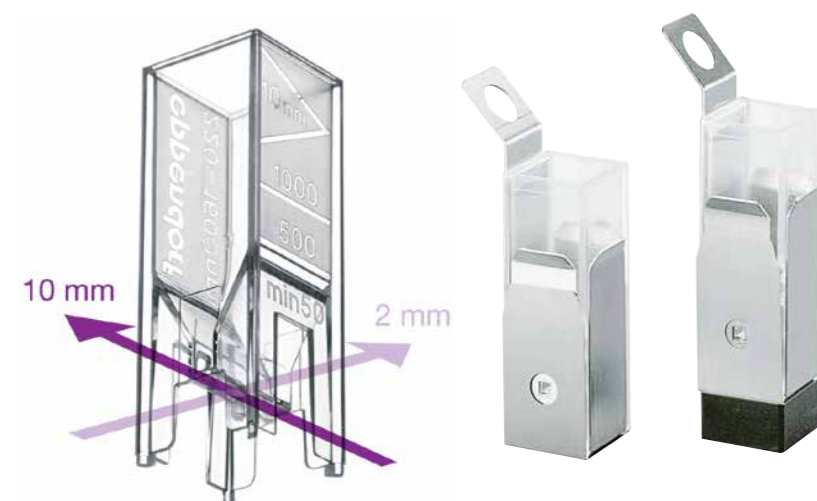

### Product features

- > Suitable for measuring small volumes ( $\geq 50 \mu\text{L}$ )
- > UV and Vis measurements from 220 nm to 1,600 nm
- > UV transparent plastic, free of fluoropolymers and other halogenated hydrocarbons
- > Two built-in optical path lengths in a single cuvette - just turn the UVette 90° to change from 10 mm and 2 mm
- > Volume markings for 500 µL and 1,000 µL
- > Individually packaged and certified PCR clean and protein-free quality for sensitive (e.g. RNA) and valuable samples
- > Deep-lying optical window prevents scratches
- > Tapered cuvette base for optimal filling, frosted grip for labeling
- > Ideal for use in the Eppendorf BioPhotometer and Eppendorf BioSpectrometer, adapters available for use with other common spectrophotometers
- > Routine pack for convenient access to each UVette and safe storage in a reclosable box



[www.eppendorf.com/appnote228](http://www.eppendorf.com/appnote228)



[www.eppendorf.com/appnote188](http://www.eppendorf.com/appnote188)

### Ordering information

Description	Order no.
UVette® 220 nm – 1,600 nm, original Eppendorf plastic cuvette, individually packed, (including RNase-free, DNase-free) and protein-free, PCR clean, 50 – 2,000 µL, 80 pcs.	0030 106.300
UVette® starter set, 80 UVettes and 1 universal adapter for light path height of 15 mm and 8.5 mm, 50 – 2,000 µL	4099 100.007
UVette® routine pack 220 nm – 1,600 nm, reclosable box, Eppendorf Quality™, 200 pcs.	0030 106.318
Adapter for UVette®, for photometer/spectrophotometer with light path height	
8.5 mm	4099 001.009
10 mm	4099 002.005
15 mm	4099 003.001
20 mm	4099 005.004
Cuvette stand, for 16 cuvettes	4308 078.006

i For more information go to [www.eppendorf.com/photometry](http://www.eppendorf.com/photometry)

Technical specifications subject to change.

## Eppendorf Vis Cuvettes

### Description

The Eppendorf Vis Cuvettes are disposable cuvettes made of clear plastic with a light transmission of 300 nm to 900 nm. The Vis cuvettes are the perfect tool for applications outside of the UV range, for example, colorimetric protein assays (Bradford, Lowry, etc.), determining of the optical density of bacterial cultures (OD 600 methods), kinetic, and fluorescence measurements. Based on the volume you would like to measure, you can select semi-micro or macro cuvette.



### Product features

- > Two different cuvette sizes (semi-micro and macro) for a wide variety of volumes and applications
- > Disposable cuvettes made of clear plastic with a light transmission of 300 nm to 900 nm

### Ordering information

Description	Order no.
Eppendorf macro Vis Cuvette, plastic cuvette for measurements in the Vis range, max. filling volume 4,500 µL	
1,000 cuvettes (10 boxes x 100 cuvettes)	0030 079.345
Eppendorf semi-micro Vis Cuvette, plastic cuvette for measurements in the Vis range, max. filling volume 3,000 µL	
1,000 cuvettes (10 boxes x 100 cuvettes)	0030 079.353
Cuvette stand, for 16 cuvettes	4308 078.006

## Thermal Printer DPU-S445

### Description

The Thermal Printer DPU-S445 is a thermal line dot printer with high printing speed while producing a clear type face. This allows the Thermal Printer DPU-S445 to print out scanned images. As an alternative to using USB sticks, the automatic print-out function of the DPU-S445 printer can be used to quickly obtain the results.



### Product features

- > Automatic print-out of results
- > Easy and direct connection via USB
- > Compact and light-weight (approx. 0.5 kg)
- > Easy paper operation
- > Max. printing speed: 90 mm/sec.
- > Number of dots/line: 832
- > Resolution (dots/mm): 8

### Ordering information

Description	Order no.
Thermal Printer DPU-S445	6135 011.000
Thermal paper	
5 rolls	0013 021.566

✂ Ordering information for other voltage options begins on page 434

Your local distributor: [www.eppendorf.com/contact](http://www.eppendorf.com/contact)

Eppendorf AG · Barkhausenweg 1 · 22339 Hamburg · Germany · [eppendorf@eppendorf.com](mailto:eppendorf@eppendorf.com) · [www.eppendorf.com](http://www.eppendorf.com)

## Eppendorf BioPhotometer® D30 Reference Filter Set

The secondary UV/Vis Eppendorf BioSpectrometer D30 Reference Filter Set: is used for verifying the photometric accuracy and wavelength systematic error on the Eppendorf BioPhotometer D30.



### Product features

- > Filter traceable to NIST®
- > Filter recertification via Eppendorf (contact: Eppendorf Service)
- > Inspection protocol preprogrammed in device
- > Verification of wavelength accuracy and precision at 260 nm and 280 nm
- > Verification of the photometric accuracy and precision for all Eppendorf BioPhotometer D30 wavelengths
- > Contains 6 filters (1 blank filter, 2 filters for checking UV/Vis wavelength systematic error and precision, 3 filters for photometric verification)

### Ordering information

Description	Order no.
Eppendorf BioPhotometer® D30 Reference Filter Set, filter set for verifying photometric accuracy and wavelength systematic error (according to NIST®)	6133 928.004



[www.eppendorf.com/whitepaper033](http://www.eppendorf.com/whitepaper033)

## Eppendorf BioSpectrometer® Reference Filter Sets

The secondary UV/Vis Eppendorf BioSpectrometer Reference Filter Set:

is used to verify photometric accuracy and wavelength systematic error. The reference filter can be used with the Eppendorf BioSpectrometer basic and the Eppendorf BioSpectrometer kinetic.



### Product features

- > Filter traceable to NIST®
- > Filter recertification via Eppendorf (contact: Eppendorf Service)
- > Inspection protocol preprogrammed in device
- > Verification of wavelength accuracy and precision at 260 nm, 280 nm and 800 nm
- > Verification of the photometric accuracy and precision in the 260 nm to 800 nm range
- > The variation coefficient is listed along with the average value of 15 measurements.
- > Contains 7 filters (1 blank filter, 3 filters for checking UV/Vis wavelength systematic error and precision, 3 filters for photometric verification)

The Eppendorf BioSpectrometer Fluorescence Reference Filter Set: is used to verify photometric accuracy, wavelength systematic error, and fluorimetric precision (random error) and linearity on the Eppendorf BioSpectrometer fluorescence.

### Product features

- > All features of the Eppendorf BioSpectrometer UV/Vis Reference Filter Set
- > Additional filter for verifying fluorimetric precision (random error) and linearity
- > Inspection protocol preprogrammed in device
- > 8 filters (1 blank filter, 3 filters for checking UV/Vis wavelength systematic error and precision, 3 filters for UV/Vis photometric verification, 1 filter for fluorometric verification)

### Ordering information

Description	Order no.
Eppendorf BioSpectrometer® Reference Filter Set, filter set for verifying photometric accuracy and wavelength systematic error (according to NIST®)	6135 928.001
Eppendorf BioSpectrometer® fluorescence Reference Filter Set, filter set for verifying photometric accuracy and wavelength systematic error (according to NIST®) and verifying fluorimetric precision (random error) and linearity	6137 928.009

# Sample Handling



Model	MC X50s	MC X50a	MC X50p	MC X50h
Page(s)	230	230	230	230
Dimensions (W x D x H)	27.5 x 43 x 33 cm	27.5 x 43 x 33 cm	27.5 x 43 x 33 cm	27.5 x 43 x 33 cm
2D-Gradient block	over 12 columns/over 8 rows	over 12 columns/over 8 rows	over 12 columns/over 8 rows	over 24 columns/over 16 rows
Gradient block	-	-	-	-
Heating rate	10 °C/s	5 °C/s	5 °C/s	5 °C/s
Cooling rate	5 °C/s	2.3 °C/s	2.3 °C/s	2.3 °C/s
Interfaces	Ethernet, USB	Ethernet, USB	Ethernet, USB	Ethernet, USB
Lid descent	flexlid	flexlid	flexlid	flexlid
Lid temperature range	37 – 110 °C	37 – 110 °C	37 – 110 °C	37 – 110 °C
Sample capacity	96 x 0.2 mL PCR vessels, 1 PCR plate 8 x 12	96 x 0.2 mL PCR vessels, 1 PCR plate 8 x 12	1 PCR plate 8 x 12	1 PCR plate 16 x 24
Gradient temperature range	30 – 99 °C	30 – 99 °C	30 – 99 °C	30 – 99 °C
Temperature control range of the block	4 – 99 °C	4 – 99 °C	4 – 99 °C	4 – 99 °C
Thermoblock	Silver	Aluminum	Aluminum	Aluminum

<sup>1)</sup> measured at the block

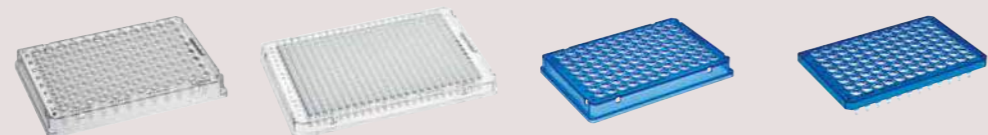

	Eppendorf twin.tec® PCR Plates LoBind		Eppendorf twin.tec® PCR Plates	
Model	Eppendorf twin.tec® PCR Plates 96 LoBind	Eppendorf twin.tec® PCR Plates 384 LoBind	Eppendorf twin.tec® PCR Plate 96 skirted	Eppendorf twin.tec® PCR Plate 96 unskirted
Page(s)	238	238	238	238
Number of wells	96 wells	384 wells	96 wells	96 wells
Total volume per well	150 or 250 µL	40 µL	150 µL	150 or 250 µL
OptiTrack® frame color	colorless yellow green blue red	colorless	colorless yellow green blue red	colorless blue



Model	MC nexus GSX1	MC nexus SX1	MC nexus gradient	MC nexus	MC nexus GX2
Page(s)	234	234	234	234	236
Dimensions (W x D x H)	25 x 41.2 x 32.1 cm	25 x 41.2 x 32.1 cm	25 x 41.2 x 32.1 cm	25 x 41.2 x 32.1 cm	25 x 41.2 x 32.1 cm
2D-Gradient block	-	-	-	-	-
Gradient block	Over 12 rows (0.2 mL)		Over 12 rows (0.2 mL)		Over 8 rows
Heating rate	5 °C/s <sup>1)</sup>	5 °C/s <sup>1)</sup>	3 °C/s <sup>1)</sup>	3 °C/s <sup>1)</sup>	3 °C/s <sup>1)</sup>
Cooling rate	3.5 °C/s <sup>1)</sup>	3.5 °C/s <sup>1)</sup>	2 °C/s <sup>1)</sup>	2 °C/s <sup>1)</sup>	2 °C/s <sup>1)</sup>
Interfaces	CAN_in/CAN_out, Ethernet, USB	CAN_in/CAN_out, Ethernet, USB	CAN_in/CAN_out, Ethernet, USB	CAN_in/CAN_out, Ethernet, USB	CAN_in/CAN_out, Ethernet, USB
Lid descent	flexlid® technology, with TSP	flexlid® technology, with TSP	flexlid® technology, with TSP	flexlid® technology, with TSP	flexlid® technology, with TSP
Lid temperature range	37 – 110 °C	37 – 110 °C	37 – 110 °C	37 – 110 °C	37 – 110 °C
Sample capacity	96 x 0.2 mL PCR vessels, 1 PCR plate 8 x 12	96 x 0.2 mL PCR vessels, 1 PCR plate 8 x 12	96 x 0.2 mL PCR tubes, 1 PCR plate 8 x 12 or 38 x 0.5 mL PCR tubes	96 x 0.2 mL PCR tubes, 1 PCR plate 8 x 12 or 38 x 0.5 mL PCR tubes	64/32 x 0.2 mL PCR tubes or 24/10 x 0.5 mL PCR tubes
Gradient temperature range	30 – 99 °C		30 – 99 °C		30 – 99 °C
Temperature control range of the block	4 – 99 °C	4 – 99 °C	4 – 99 °C	4 – 99 °C	4 – 99 °C
Thermoblock	Silver	Silver	Aluminum	Aluminum	Aluminum

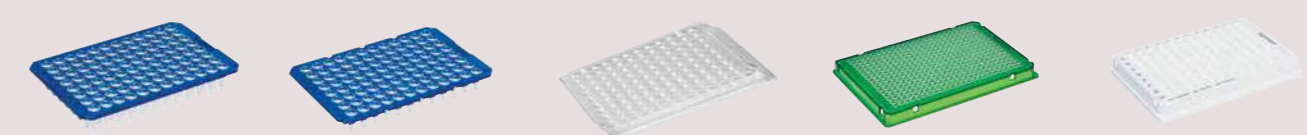

	Eppendorf twin.tec® PCR Plate 96 semi-skirted	Eppendorf twin.tec® PCR Plate 96 unskirted, divisible	Eppendorf twin.tec® microbiology PCR Plate 96	Eppendorf twin.tec® PCR Plate 384	Eppendorf twin.tec® 96 real-time PCR Plates
Page(s)	238	238	238	240	240
Number of wells	96 wells	96 wells	96 wells	384 wells	96 wells
Total volume per well	250 µL	150 or 250 µL	150 or 250 µL	40 µL	150 or 250 µL
OptiTrack® frame color	colorless yellow green blue red	colorless blue	colorless blue	colorless yellow green blue red	white blue

**epServices** for premium performance. On page 372 you will find detailed information on services for these products!

# NEW - Mastercycler® X50

## Description

Speed and enhanced PCR optimization functions like the 2D-Gradient make the Mastercycler X50 the ideal PCR cycler for advanced research in molecular biology. The excellent block temperature regulation gives rise to the next stage of PCR reproducibility, whereas the adaptable user management and profound documentation capabilities give peace of mind to laboratories working to set standards.

A highly intuitive touch display, low noise levels, low power consumption, and the versatile flexlid® concept complete the product to be a powerful PCR cycler. Up to 10 PCR cyclers can be combined – ideal for high throughput applications or labs with a high number of users running different assays. Should you feel you need more flexibility or throughput, up to 50 PCR cyclers can be combined in a computer-controlled network.



1. Innovative 2D-Gradient for advanced PCR optimization
2. Heating rate: up to 10 °C/s
3. Wide selection of blocks from a fast silver block to 384
4. Intuitive touch display
5. Connect up to 10 units to a network
6. flexlid® concept: automatic height adjustment of the lid allows you to use all types of consumables
7. Small footprint
8. 2 year warranty

## Ordering information

Description	Order no.
Mastercycler® X50s, 110 – 230 V/50 – 60 Hz, silver block, 96-well plate or 0.1/0.2 mL tubes	6311 000.010
Mastercycler® X50a, 110 – 230 V/50 – 60 Hz, aluminum block, 96-well plate or 0.1/0.2 mL tubes	6313 000.018
Mastercycler® X50p, 110 – 230 V/50 – 60 Hz, aluminum block, 96-well plate, high pressure lid	6315 000.015
Mastercycler® X50h, 110 – 230 V/50 – 60 Hz, aluminum block, 384-well plate, high pressure lid	6316 000.019
Mastercycler® X50i, 110 – 230 V/50 – 60 Hz, silver block, 96-well plate or 0.1/0.2 mL tubes	6301 000.012
Mastercycler® X50l, 110 – 230 V/50 – 60 Hz, aluminum block, 96-well plate or 0.1/0.2 mL tubes	6303 000.010
Mastercycler® X50r, 110 – 230 V/50 – 60 Hz, aluminum block, 96-well plate, high pressure lid	6305 000.017
Mastercycler® X50t, 110 – 230 V/50 – 60 Hz, aluminum block, 384-well plate, high pressure lid	6306 000.010

## Applications

- > Fast PCR
- > PCR optimization
- > Standard PCR
- > Incubation
- > Cycle sequencing



- > This icon tags devices that are connectable to the Eppendorf VisioNize system. Further information are available at pages 12 – 13.

Technical specifications	MC X50s	MC X50a	MC X50p	MC X50h	MC X50i	MC X50l	MC X50r	MC X50t
Model	MC X50s	MC X50a	MC X50p	MC X50h	MC X50i	MC X50l	MC X50r	MC X50t
Touchscreen Interface	■	■	■	■	–	–	–	–
Unit can control 9 other units in network	■	■	■	■	–	–	–	–
Unit can only be controlled	–	–	–	–	■	■	■	■
Thermoblock	Silver	Aluminum	Aluminum	Aluminum	Silver	Aluminum	Aluminum	Aluminum
High pressure lid	–	–	■	■	–	–	■	■
96-well plate	■	■	■	–	■	■	■	–
384-well plate	–	–	–	■	–	–	–	■
0.1/0.2 mL tubes	■	■	–	–	■	■	–	–
Temperature control range of the block	4 – 99 °C	4 – 99 °C	4 – 99 °C	4 – 99 °C	4 – 99 °C	4 – 99 °C	4 – 99 °C	4 – 99 °C
Temperature control mode	Fast, Intermediate, Standard, Safe	Fast, Intermediate, Standard, Safe	Fast, Intermediate, Standard, Safe	Fast, Intermediate, Standard, Safe	Fast, Intermediate, Standard, Safe	Fast, Intermediate, Standard, Safe	Fast, Intermediate, Standard, Safe	Fast, Intermediate, Standard, Safe
Heating technology	Six peltier elements	Six peltier elements	Six peltier elements	Six peltier elements	Six peltier elements	Six peltier elements	Six peltier elements	Six peltier elements
2D-Gradient block	over 12 columns/ over 8 rows	over 12 columns/ over 8 rows	over 12 columns/ over 8 rows	over 24 columns/ over 16 rows	over 12 columns/ over 8 rows	over 12 columns/ over 8 rows	over 12 columns/ over 8 rows	over 24 columns/ over 16 rows
Sample capacity	96 × 0.2 mL PCR vessels, 1 PCR plate 8 × 12	96 × 0.2 mL PCR vessels, 1 PCR plate 8 × 12	1 PCR plate 8 × 12	1 PCR plate 16 × 24				
Gradient range	1 – 30 °C	1 – 30 °C	1 – 30 °C	1 – 30 °C	1 – 30 °C	1 – 30 °C	1 – 30 °C	1 – 30 °C
Gradient temperature range	30 – 99 °C	30 – 99 °C	30 – 99 °C	30 – 99 °C	30 – 99 °C	30 – 99 °C	30 – 99 °C	30 – 99 °C
Lid temperature range	37 – 110 °C	37 – 110 °C	37 – 110 °C	37 – 110 °C	37 – 110 °C	37 – 110 °C	37 – 110 °C	37 – 110 °C
Lid descent	flexlid	flexlid	flexlid	flexlid	flexlid	flexlid	flexlid	flexlid
Block homogeneity 20 – 72 °C	≤±0.2 °C	≤±0.2 °C	≤±0.2 °C	≤±0.2 °C	≤±0.2 °C	≤±0.2 °C	≤±0.2 °C	≤±0.2 °C
Block homogeneity 95 °C	≤±0.3 °C	≤±0.3 °C	≤±0.3 °C	≤±0.3 °C	≤±0.3 °C	≤±0.3 °C	≤±0.3 °C	≤±0.3 °C
Block temperature accuracy	±0.15 °C	±0.15 °C	±0.15 °C	±0.15 °C	±0.15 °C	±0.15 °C	±0.15 °C	±0.15 °C
Heating rate	10 °C/s	5 °C/s	5 °C/s	5 °C/s	10 °C/s	5 °C/s	5 °C/s	5 °C/s
Cooling rate	5 °C/s	2.3 °C/s	2.3 °C/s	2.3 °C/s	5 °C/s	2.3 °C/s	2.3 °C/s	2.3 °C/s
Gradient block	–	–	–	–				
Interfaces	Ethernet, USB	Ethernet, USB	Ethernet, USB	Ethernet, USB	Ethernet, USB	Ethernet, USB	Ethernet, USB	Ethernet, USB
Total weight	11.5 kg	11.5 kg	11.5 kg	11.5 kg	10.7 kg	10.7 kg	10.7 kg	10.7 kg
Power supply	110 – 230 V, 50 – 60 Hz	110 – 230 V, 50 – 60 Hz	110 – 230 V, 50 – 60 Hz	110 – 230 V, 50 – 60 Hz	110 – 230 V, 50 – 60 Hz	110 – 230 V, 50 – 60 Hz	110 – 230 V, 50 – 60 Hz	110 – 230 V, 50 – 60 Hz
Max. power consumption	850 W	850 W	850 W	850 W	850 W	850 W	850 W	850 W
Dimensions (W × D × H)	27.5 × 43 × 33 cm	27.5 × 43 × 33 cm	27.5 × 43 × 33 cm	27.5 × 43 × 33 cm	27.5 × 43 × 33 cm	27.5 × 43 × 33 cm	27.5 × 43 × 33 cm	27.5 × 43 × 33 cm

# Mastercycler® nexus

## Description

In the age of networking, the new Mastercycler nexus is your reliable companion when it comes to the daily routine of PCR. It is easy to use, does not need much space or energy and sends you an e-mail when it is done – what else do you need from a PCR cycler?



### Product features

- > Intuitive graphic programming
- > Small footprint
- > Universal block for ultimate flexibility
- > Connect up to 2 Mastercycler nexus eco to your existing unit
- > Available with gradient
- > E-mail notification
- > flexlid® concept allows use of all types of consumables with automatic height adjustment of the lid

### Applications

- > Standard PCR
- > Fast PCR
- > Optimizing a PCR
- > *In situ* PCR

### Ordering information

Description	Order no.
Mastercycler® nexus GSX1, 230 V/50 – 60 Hz	6345 000.010
Mastercycler® nexus SX1, 230 V/50 – 60 Hz	6346 000.013
Mastercycler® nexus GSX1e, 230 V/50 – 60 Hz	6347 000.017
Mastercycler® nexus SX1e, 230 V/50 – 60 Hz	6348 000.010
Mastercycler® nexus gradient, 230 V/50 – 60 Hz	6331 000.017
Mastercycler® nexus, 230 V/50 – 60 Hz	6333 000.014
Mastercycler® nexus gradient eco, 230 V/50 – 60 Hz	6334 000.018
Mastercycler® nexus eco, 230 V/50 – 60 Hz	6332 000.010
Mastercycler® nexus flat, 230 V/50 – 60 Hz	6335 000.011
Mastercycler® nexus flat eco, 230 V/50 – 60 Hz	6330 000.013
CAN bus connecting cable, 150 cm	5341 611.000
CAN bus connecting cable, 50 cm	5341 612.006

✎ Ordering information for other voltage options begins on page 434

i For more information go to [www.eppendorf.com/Mastercycler](http://www.eppendorf.com/Mastercycler)

# Mastercycler® nexus X2

## Description

The Mastercycler nexus X2 gives you the ability to run two totally independent protocols at the same time. Smaller assays fit nicely on the 32-well-block – larger assays can exceed 48 samples and run on the 64-well-block. The larger block is available with a gradient function. As every member of the Mastercycler nexus family, the Mastercycler nexus X2 can be combined with all other family members in a network of up to 3 units. In combination with Eppendorf's PCR Tubes, PCR Strips or divisible plates, the Mastercycler nexus X2 will give you consistent and publishable results – every day!



### Product features

- > Large block for large assays – small block for small assays
- > Intuitive graphic programming
- > Universal block for strips, 0.1 mL, 0.2 mL and 0.5 mL PCR tubes
- > Small footprint
- > Optional gradient for PCR optimization
- > E-mail notification
- > flexlid® concept allows use of all types of consumables with automatic height adjustment of the lid

### Applications

- > Standard PCR
- > Optimizing a PCR

### Ordering information

Description	Order no.
Mastercycler® nexus GX2, 230 V/50 – 60 Hz	6336 000.015
Mastercycler® nexus GX2e, 230 V/50 – 60 Hz	6338 000.012
Mastercycler® nexus X2, 230 V/50 – 60 Hz	6337 000.019
Mastercycler® nexus X2e, 230 V/50 – 60 Hz	6339 000.016

✎ Ordering information for other voltage options begins on page 434



[www.eppendorf.com/nexus-x2-brochure](http://www.eppendorf.com/nexus-x2-brochure)

i For more information go to [www.eppendorf.com/pcr](http://www.eppendorf.com/pcr)

# Mastercycler® nexus

Technical specifications					
Model	MC nexus GSX1	MC nexus SX1	MC nexus GSX1e	MC nexus SX1e	MC nexus gradient
Thermoblock	Silver	Silver	Silver	Silver	Aluminum
Temperature control range of the block	4 – 99 °C	4 – 99 °C	4 – 99 °C	4 – 99 °C	4 – 99 °C
Temperature control mode	Fast, standard, safe	Fast, standard, safe	Fast, standard, safe	Fast, standard, safe	Fast, Standard, Safe
Heating technology	Peltier elements, triple circuit technology	Peltier elements, triple circuit technology	Peltier elements, triple circuit technology	Peltier elements, triple circuit technology	Peltier elements, Triple Circuit Technology
Intuitive graphic programming	■	■	■	■	■
E-mail Notification	■	■	■	■	■
Sample capacity	96 × 0.2 mL PCR vessels, 1 PCR plate 8 × 12	96 × 0.2 mL PCR vessels, 1 PCR plate 8 × 12	96 × 0.2 mL PCR vessels, 1 PCR plate 8 × 12	96 × 0.2 mL PCR vessels, 1 PCR plate 8 × 12	96 × 0.2 mL PCR tubes, 1 PCR plate 8 × 12 or 38 × 0.5 mL PCR tubes
flexlid® concept	■	■	■	■	■
2 years warranty	■	■	■	■	■
Silver block	■	■	■	■	–
Gradient range	1 – 20 °C		1 – 20 °C		1 – 20 °C
Gradient block	■	■	■	■	■
Gradient temperature range	30 – 99 °C		30 – 99 °C		30 – 99 °C
Lid temperature range	37 – 110 °C	37 – 110 °C	37 – 110 °C	37 – 110 °C	37 – 110 °C
Unit can control 2 other units in network	■	■	■	■	■
Unit can only be controlled <sup>1)</sup>			■	■	
Lid descent	flexlid® technology, with TSP	flexlid® technology, with TSP	flexlid® technology, with TSP	flexlid® technology, with TSP	flexlid® technology, with TSP
USB port	■	■	■	■	■
Block homogeneity 20–72 °C	≤ ±0.3 °C	≤ ±0.3 °C	≤ ±0.3 °C	≤ ±0.3 °C	≤ ±0.3 °C
Block homogeneity 90 °C	≤ ±0.4 °C	≤ ±0.4 °C	≤ ±0.4 °C	≤ ±0.4 °C	≤ ±0.4 °C
Block temperature accuracy	±0.2 °C	±0.2 °C	±0.2 °C	±0.2 °C	±0.2 °C
Heating rate	5 °C/s <sup>2)</sup>	5 °C/s <sup>2)</sup>	5 °C/s <sup>2)</sup>	5 °C/s <sup>2)</sup>	3 °C/s <sup>2)</sup>
Cooling rate	3.5 °C/s <sup>2)</sup>	3.5 °C/s <sup>2)</sup>	3.5 °C/s <sup>2)</sup>	3.5 °C/s <sup>2)</sup>	2 °C/s <sup>2)</sup>
Gradient block	Over 12 rows (0.2 mL)		Over 12 rows (0.2 mL)		Over 12 rows (0.2 mL)
Interfaces	CAN_in/CAN_out, Ethernet, USB	CAN_in/CAN_out, Ethernet, USB	CAN_in/CAN_out, Ethernet	CAN_in/CAN_out, Ethernet	CAN_in/CAN_out, Ethernet, USB
Total weight	10.9 kg	10.9 kg	10.4 kg	10.4 kg	10.9 kg
Power supply	230 V, 50 – 60 Hz	230 V, 50 – 60 Hz	230 V, 50 – 60 Hz	230 V, 50 – 60 Hz	230 V, 50 – 60 Hz
Max. power consumption	540 W	540 W	540 W	540 W	700 W
Dimensions (W × D × H)	25 × 41.2 × 32.1 cm	25 × 41.2 × 32.1 cm	25 × 41.2 × 32.1 cm	25 × 41.2 × 32.1 cm	25 × 41.2 × 32.1 cm
Number of programs on device	> 700	> 700	> 700	> 700	> 700

<sup>1)</sup> Control through a Mastercycler® nexus, Mastercycler® nexus gradient, Mastercycler® nexus GSX1, Mastercycler® nexus SX1, Mastercycler® nexus GX2, Mastercycler® nexus X2 or Mastercycler® nexus flat  
<sup>2)</sup> measured at the block

Technical specifications					
Model	MC nexus	MC nexus gradient eco	MC nexus eco	MC nexus flat	MC nexus flat eco
Thermoblock	Aluminum	Aluminum	Aluminum	Aluminum	Aluminum
Temperature control range of the block	4 – 99 °C	4 – 99 °C	4 – 99 °C	4 – 99 °C	4 – 99 °C
Temperature control mode	Fast, standard, safe	Fast, standard, safe	Fast, standard, safe	Fast, standard, safe	Fast, standard, safe
Heating technology	Peltier elements, triple circuit technology	Peltier elements, triple circuit technology	Peltier elements, triple circuit technology	Peltier elements, triple circuit technology	Peltier elements, triple circuit technology
Intuitive graphic programming	■			■	
E-mail Notification	■	■	■	■	■
Sample capacity	96 × 0.2 mL PCR tubes, 1 PCR plate 8 × 12 or 38 × 0.5 mL PCR tubes	96 × 0.2 mL PCR tubes, 1 PCR plate 8 × 12 or 38 × 0.5 mL PCR tubes	96 × 0.2 mL PCR tubes, 1 PCR plate 8 × 12 or 38 × 0.5 mL PCR tubes	4 slides or other matching consumables	4 slides or other matching consumables
flexlid® concept	■	■	■	■	■
2 years warranty	■	■	■	■	■
Silver block					
Gradient range		1 – 20 °C			
Gradient block		■		■	■
Gradient temperature range		30 – 99 °C			
Lid temperature range	37 – 110 °C	37 – 110 °C	37 – 110 °C	37 – 110 °C	37 – 110 °C
Unit can control 2 other units in network	■			■	
Unit can only be controlled <sup>1)</sup>		■	■		■
Lid descent	flexlid® technology, with TSP	flexlid® technology, with TSP	flexlid® technology, with TSP	flexlid® technology, with TSP	flexlid® technology, with TSP
USB port	■			■	
Block homogeneity 20–72 °C	≤ ±0.3 °C	≤ ±0.3 °C	≤ ±0.3 °C	≤ ±0.3 °C	≤ ±0.3 °C
Block homogeneity 90 °C	≤ ±0.4 °C	≤ ±0.4 °C	≤ ±0.4 °C	≤ ±0.4 °C	≤ ±0.4 °C
Block temperature accuracy	±0.2 °C	±0.2 °C	±0.2 °C	±0.2 °C	±0.2 °C
Heating rate	3 °C/s <sup>2)</sup>	3 °C/s <sup>2)</sup>	3 °C/s <sup>2)</sup>	3 °C/s <sup>2)</sup>	3 °C/s <sup>2)</sup>
Cooling rate	2 °C/s <sup>2)</sup>	2 °C/s <sup>2)</sup>	2 °C/s <sup>2)</sup>	2 °C/s <sup>2)</sup>	2 °C/s <sup>2)</sup>
Gradient block		Over 12 rows (0.2 mL)			
Interfaces	CAN_in/CAN_out, Ethernet, USB	CAN_in/CAN_out, Ethernet	CAN_in/CAN_out, Ethernet	CAN_in/CAN_out, Ethernet, USB	CAN_in/CAN_out, Ethernet
Total weight	10.9 kg	10.4 kg	10.9 kg	10.4 kg	10.4 kg
Power supply	230 V, 50 – 60 Hz	230 V, 50 – 60 Hz	230 V, 50 – 60 Hz	230 V, 50 – 60 Hz	230 V, 50 – 60 Hz
Max. power consumption	700 W	700 W	700 W	700 W	700 W
Dimensions (W × D × H)	25 × 41.2 × 32.1 cm	25 × 41.2 × 32.1 cm	25 × 41.2 × 32.1 cm	25 × 41.2 × 32.1 cm	25 × 41.2 × 32.1 cm
Number of programs on device	> 700	> 700	> 700	> 700	> 700

<sup>1)</sup> Control through a Mastercycler® nexus, Mastercycler® nexus gradient, Mastercycler® nexus GSX1, Mastercycler® nexus SX1, Mastercycler® nexus GX2, Mastercycler® nexus X2 or Mastercycler® nexus flat  
<sup>2)</sup> measured at the block

For more information go to [www.eppendorf.com/Mastercycler](http://www.eppendorf.com/Mastercycler)

# Mastercycler® nexus X2

Technical specifications				
Model	MC nexus GX2	MC nexus GX2e	MC nexus X2	MC nexus X2e
Thermoblock	Aluminum	Aluminum	Aluminum	Aluminum
Temperature control range of the block	4 – 99 °C	4 – 99 °C	4 – 99 °C	4 – 99 °C
Temperature control mode	Fast, Standard, Safe	Fast, Standard, Safe	Fast, Standard, Safe	Fast, Standard, Safe
Heating technology	Peltier elements, Triple Circuit Technology	Peltier elements, Triple Circuit Technology	Peltier elements, Triple Circuit Technology	Peltier elements, Triple Circuit Technology
Intuitive graphic programming		■	■	■
E-mail Notification		■	■	■
Sample capacity	64/32 × 0.2 mL PCR tubes or 24/10 × 0.5 mL PCR tubes	64/32 × 0.2 mL PCR tubes or 24/10 × 0.5 mL PCR tubes	64/32 × 0.2 mL PCR tubes or 24/10 × 0.5 mL PCR tubes	64/32 × 0.2 mL PCR tubes or 24/10 × 0.5 mL PCR tubes
flexlid® concept	■	■	■	■
2 years warranty	■	■	■	■
Universal Block for 0.2 mL and 0.5 mL vessels	■	■	■	■
Gradient range	1 – 12 °C	1 – 12 °C		
Gradient block	■	■		
Gradient temperature range	30 – 99 °C	30 – 99 °C		
Lid temperature range	37 – 110 °C	37 – 110 °C	37 – 110 °C	37 – 110 °C
Unit can control 2 other units in network	■		■	
Unit can only be controlled <sup>1)</sup>		■	–	■
Lid descent	flexlid® technology, with TSP	flexlid® technology, with TSP	flexlid® technology, with TSP	flexlid® technology, with TSP
USB port	■	–	■	
Block homogeneity 20–72 °C	≤ ±0.3 °C	≤ ±0.3 °C	≤ ±0.3 °C	≤ ±0.3 °C
Block homogeneity 90 °C	≤ ±0.4 °C	≤ ±0.4 °C	≤ ±0.4 °C	≤ ±0.4 °C
Block temperature accuracy	±0.2 °C	±0.2 °C	±0.2 °C	±0.2 °C
Heating rate	3 °C/s <sup>2)</sup>	3 °C/s <sup>2)</sup>	3 °C/s <sup>2)</sup>	3 °C/s <sup>2)</sup>
Cooling rate	2 °C/s <sup>2)</sup>	2 °C/s <sup>2)</sup>	2 °C/s <sup>2)</sup>	2 °C/s <sup>2)</sup>
Gradient block	Over 8 rows	Over 8 rows		
Interfaces	CAN_in/CAN_out, Ethernet, USB	CAN_in/CAN_out, Ethernet	CAN_in/CAN_out, Ethernet, USB	CAN_in/CAN_out, Ethernet
Total weight	11 kg	11 kg	11 kg	11 kg
Max. power consumption	700 W	540 W	700 W	540 W
Dimensions (W × D × H)	25 × 41.2 × 32.1 cm	25 × 41.2 × 32.1 cm	25 × 41.2 × 32.1 cm	25 × 41.2 × 32.1 cm
Number of programs on device	> 700	> 700	> 700	> 700

<sup>1)</sup> Control through a Mastercycler® nexus, Mastercycler® nexus gradient, Mastercycler® nexus GSX1, Mastercycler® nexus SX1, Mastercycler® nexus GX2, Mastercycler® nexus X2 or Mastercycler® nexus flat

<sup>2)</sup> measured at the block



[www.eppendorf.com/nexus-x2-info](http://www.eppendorf.com/nexus-x2-info)

For more information go to [www.eppendorf.com/Mastercycler](http://www.eppendorf.com/Mastercycler)

# Temperature Verification System – USB – Single Channel



## Temperature Verification System – USB – Single Channel

- > Measuring device without temperature sensor
- > Sensor for 96 well and 384 well blocks, sold separately
- > Simple, rapid verification and adjustment
- > Automatic adjustment with Mastercycler software, version 2.10 or higher
- > Can be third-party adjusted

## Ordering information

Description	Order no.
Temperature Verification System - USB - Single Channel	0056 000.003
Temperature sensor for 96 Well	0056 001.000
Temperature sensor for 384 Well	0056 002.006

# HeatSealer



## Product features

- > Hermetic sealing of multiwell plates
- > Fixed sealing temperature for reproducible results (S100)
- > Adjustable sealing temperatures for more flexibility (S200)
- > Eliminates evaporation in PCR, reducing cross contamination
- > Seals 96- and 384-well plates
- > Compact design, portable device
- > Integrated thermostats prevents overheating
- > Improved mechanics for even easier sealing
- > PCR Plate Adapter included

## Ordering information

Description	Order no.
HeatSealer S100, 100 – 230 V/50 – 60 Hz	5391 000.001
HeatSealer S200, 100 – 230 V/50 – 60 Hz	5392 000.005
Plate Adapter low profile, for HeatSealer S100	5391 070.018
Plate Adapter high profile, for HeatSealer S100	5391 070.034
96-well-PCR Plate Adapter, for HeatSealer S100	5391 070.026
Plate Adapter high profile, for HeatSealer S200	5392 070.011
Plate Adapter low profile, for HeatSealer S200	5392 070.020
96-well Plate Adapter, for HeatSealer S200	5392 070.038
Eppendorf Heat Sealing Film, PCR clean, 100 pcs.	0030 127.838
Eppendorf Heat Sealing Foil, PCR clean, 100 pcs.	0030 127.854

# Eppendorf twin.tec® PCR Plates

## Product features

- > One-piece design: combining a polycarbonate frame and polypropylene wells for optimum performance
- > Extremely thin-walled polypropylene wells guarantee optimum heat transfer to the sample
- > Exceptionally solid and torque-resistant polycarbonate frame
- > Improved well-to-well tolerance
- > Cut-away corner and alphanumeric grid-referencing
- > Raised well rims for effective sealing, also reduces risk of cross-contamination
- > Certified free of any detectable human DNA, DNase, RNase and PCR inhibitors<sup>1)</sup>
- > Available with barcode (upon request)
- > Ideal for quantitative real-time PCR as well

<sup>1)</sup> Download of certificates under [www.eppendorf.com/certificates](http://www.eppendorf.com/certificates)



## Eppendorf twin.tec® PCR Plate 96, skirted

- > Optimized rim for barcodes and automated work processes
- > Within SBS footprint recommendations (127.76 × 85.47 mm ±0.25 mm)
- > Stackable
- > Eight holes in the skirt aid plate positioning and removal from the thermal cycler block
- > Low profile design enhances efficiency of PCR and enables the highest efficiency for small sample volumes
- > 150 µL max. well volume (when used with cap strips)
- > Available with barcode (upon request)
- > Ideal for quantitative real-time PCR as well – OptiTrack® matrix for faster sample identification and fewer pipetting errors

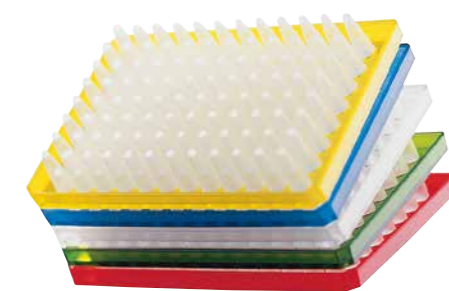

## Eppendorf twin.tec® PCR Plate 96, semi-skirted

- > Semi-skirted for label and barcode
- > Fits most thermal cyclers
- > 250 µL max. well volume (when used with cap strips)
- > Improved well-to-well tolerance
- > Available with barcode (upon request)
- > Ideal for quantitative real-time PCR as well – OptiTrack® matrix for faster sample identification and fewer pipetting errors



## Eppendorf twin.tec® PCR Plate 96, unskirted

- > Fits even more thermal cyclers
- > OptiTrack® matrix for faster sample identification and fewer pipetting errors
- > Available with regular (250 µL) or low profile (150 µL) wells
- > Available with barcode (upon request)
- > Ideal for quantitative real-time PCR as well

► For more Assay/Reader MTPs go to page 112



## Eppendorf twin.tec® PCR Plate 96, unskirted, divisible

- > Can be divided in 4 segments of 24 wells each
- > Fits most common thermal cyclers
- > OptiTrack® matrix for faster sample identification and fewer pipetting errors
- > Available with regular (250 µL) or low profile (150 µL) wells
- > Can be divided into 4 segments of 24 wells each to prevent waste and save money
- > Available with barcode (upon request)
- > Ideal for quantitative real-time PCR as well



## Eppendorf twin.tec® microbiology PCR Plate 96

- > Individually blistered
- > Certified PCR clean
- > Additionally free of bacterial DNA
- > For all applications that need ultimate purity or certified absence of bacterial DNA
- > Available with barcode (upon request)
- > Ideal for quantitative real-time PCR as well – OptiTrack® matrix for faster sample identification and fewer pipetting errors



## Eppendorf twin.tec® PCR Plate 384

- > Optimized rim for barcodes and automated work processes
- > Stackable
- > Within SBS footprint recommendations
- > Ideal for most common 384-well thermocyclers, particularly for Eppendorf Mastercycler pro 384
- > 40 µL max. well volume
- > Available with barcode (upon request)
- > Ideal for quantitative real-time PCR as well – OptiTrack® matrix for faster sample identification and fewer pipetting errors



## Eppendorf twin.tec® PCR Plates 96 and 384 LoBind

- > Maximum recovery rates for improved assay results
- > Available with barcode (upon request)
- > Ideal for quantitative real-time PCR as well
- > Exceptionally solid and torque-resistant polycarbonate frame
- > OptiTrack® matrix for faster sample identification and fewer pipetting errors
- > Raised well rims for effective sealing, also reduces risk of cross-contamination
- > Batch-tested and certified free of DNA, DNAase, RNase and PCR inhibitors (PCR clean)



## Eppendorf twin.tec® PCR Plates

Ordering information	
Description	Order no.
<b>Eppendorf twin.tec® PCR Plate 96</b> , skirted, 150 µL	
PCR clean, colorless, 25 pcs.	0030 128.648
Forensic DNA Grade, colorless, 10 pcs., individually wrapped	0030 129.601
PCR clean, yellow, 25 pcs.	0030 128.656
PCR clean, green, 25 pcs.	0030 128.664
PCR clean, blue, 25 pcs.	0030 128.672
PCR clean, red, 25 pcs.	0030 128.680
<b>Eppendorf twin.tec® PCR Plate 96</b> , semi-skirted, 250 µL	
PCR clean, colorless, 25 pcs.	0030 128.575
Forensic DNA Grade, colorless, 10 pcs., individually wrapped	0030 129.610
PCR clean, yellow, 25 pcs.	0030 128.583
PCR clean, green, 25 pcs.	0030 128.591
PCR clean, blue, 25 pcs.	0030 128.605
PCR clean, red, 25 pcs.	0030 128.613
<b>Eppendorf twin.tec® PCR Plate 96, low profile</b> , unskirted, 150 µL	
PCR clean, colorless, 20 pcs.	0030 133.307
PCR clean, blue, 20 pcs.	0030 133.331
<b>Eppendorf twin.tec® PCR Plate 96</b> , unskirted, 250 µL	
PCR clean, colorless, 20 pcs.	0030 133.366
PCR clean, blue, 20 pcs.	0030 133.390
<b>Eppendorf twin.tec® PCR Plate 96, divisible</b> , unskirted, 150 µL	
PCR clean, colorless, 20 pcs.	0030 133.358
PCR clean, blue, 20 pcs.	0030 133.382
<b>Eppendorf twin.tec® PCR Plate 96, divisible</b> , unskirted, 250 µL	
PCR clean, colorless, 20 pcs.	0030 133.374
PCR clean, blue, 20 pcs.	0030 133.404
<b>Eppendorf twin.tec® microbiology PCR Plate 96</b> , skirted, 150 µL	
PCR clean, colorless, 10 pcs.	0030 129.300
PCR clean, blue, 10 pcs.	0030 129.318
<b>Eppendorf twin.tec® microbiology PCR Plate 96</b> , semi-skirted, 250 µL	
PCR clean, colorless, 10 pcs.	0030 129.326
PCR clean, blue, 10 pcs.	0030 129.334
<b>Eppendorf twin.tec® microbiology PCR Plate 384</b> , skirted, 40 µL	
PCR clean, colorless, 10 pcs.	0030 129.342
PCR clean, blue, 10 pcs.	0030 129.350
<b>Eppendorf twin.tec® PCR Plate 384</b> , skirted, 40 µL	
PCR clean, colorless, 25 pcs.	0030 128.508
Forensic DNA Grade, colorless, 10 pcs., individually wrapped	0030 129.628
PCR clean, yellow, 25 pcs.	0030 128.516
PCR clean, green, 25 pcs.	0030 128.524
PCR clean, blue, 25 pcs.	0030 128.532
PCR clean, red, 25 pcs.	0030 128.540
<b>Eppendorf twin.tec® PCR Plate 96 LoBind</b> , semi-skirted, PCR clean, colorless, 25 pcs.	0030 129.504
<b>Eppendorf twin.tec® PCR Plate 96 LoBind</b> , skirted, PCR clean, colorless, 25 pcs.	0030 129.512
<b>Eppendorf twin.tec® PCR Plate 96 LoBind</b> , skirted, PCR clean, blue, 25 pcs.	0030 129.580
<b>Eppendorf twin.tec® PCR Plate 96 LoBind</b> , skirted, PCR clean, green, 25 pcs.	0030 129.660
<b>Eppendorf twin.tec® PCR Plate 96 LoBind</b> , skirted, PCR clean, red, 25 pcs.	0030 129.598
<b>Eppendorf twin.tec® PCR Plate 96 LoBind</b> , skirted, PCR clean, yellow, 25 pcs.	0030 129.679
<b>Eppendorf twin.tec® PCR Plate 384 LoBind</b> , skirted, PCR clean, colorless, 25 pcs.	0030 129.547

i For more information go to [www.eppendorf.com/Twintec](http://www.eppendorf.com/Twintec)

## Eppendorf twin.tec *real-time* PCR Plates



### Eppendorf twin.tec® 96 *real-time* PCR Plates

- > White wells for better reflection
- > High mechanical stability
- > Raised rims for effective sealing
- > Skirted and semi-skirted frames
- > Optimal heat transfer due to reduced wall thickness
- > Autoclavable (121 °C, 20 min)
- > Available with barcode (upon request)

Ordering information	
Description	Order no.
<b>Eppendorf twin.tec® 96 <i>real-time</i> PCR Plate</b> , skirted, 150 µL	
PCR clean, blue, 25 pcs.	0030 132.505
PCR clean, white, 25 pcs.	0030 132.513
<b>Eppendorf twin.tec® 96 <i>real-time</i> PCR Plate</b> , semi-skirted, 250 µL	
PCR clean, blue, 25 pcs.	0030 132.530
PCR clean, white, 25 pcs.	0030 132.548
<b>Eppendorf twin.tec® 96 <i>real-time</i> PCR Plate</b> , skirted, 150 µL	
Forensic DNA Grade, white, 10 pcs., individually wrapped	0030 129.636
<b>Eppendorf twin.tec® 96 <i>real-time</i> PCR Plate</b> , semi-skirted, 250 µL	
Forensic DNA Grade, white, 10 pcs., individually wrapped	0030 129.644
<b>Eppendorf twin.tec® 96 <i>real-time</i> PCR Plate</b> , low profile, unskirted, 150 µL	
PCR clean, white, 20 pcs.	0030 132.700
PCR clean, blue, 20 pcs.	0030 132.718

## Eppendorf PCR Tube Strips



### Eppendorf PCR Tube Strips

- > 8 reaction tubes in strip-format – ideal for small sample volumes
- > Easily adaptable for automation
- > Sealable using flat or domed strip-lids
- > Certified free from human DNA, DNase, RNase and PCR inhibitors<sup>1)</sup>

<sup>1)</sup> Download of certificates under [www.eppendorf.com/certificates](http://www.eppendorf.com/certificates)

Ordering information	
Description	Order no.
<b>Eppendorf PCR Tube Strips</b> , 0.1 mL	
PCR clean, without lids (10 × 12 strips)	0030 124.804
PCR clean, with Cap Strips, domed (10 × 12 strips)	0030 124.812
PCR clean, with Cap Strips, flat (10 × 12 strips)	0030 124.820

## Eppendorf PCR Tubes



### Eppendorf PCR Tubes

- > Contamination shield on hinged lid
- > Defined lid position due to special hinge
- > High transparency even on the tube base
- > Etched lid for labeling
- > Tight sealing
- > Easy to open
- > For use with all thermal cyclers with 0.2 mL block format
- > Also available in 8-tube strip format
- > Certified free from human DNA, DNase, RNase and PCR inhibitors<sup>1)</sup>

<sup>1)</sup> Download of certificates under [www.eppendorf.com/certificates](http://www.eppendorf.com/certificates)

#### Ordering information

Description	Order no.
<b>Eppendorf PCR Tubes, 0.2 mL</b>	
PCR clean, colorless	0030 124.332
Forensic DNA Grade, colorless, 500 pcs. (10 bags × 50 pcs.)	0030 124.707
PCR clean, 8-tube strips, 120 pcs. (960 tubes)	0030 124.359

## Eppendorf PCR Tubes, 0.5 mL



### Eppendorf PCR Tubes, 0.5 mL

- > Etched lid for labeling
- > Tight sealing
- > Easy to open
- > For use with all thermal cyclers with 0.5 mL block format
- > Certified free from human DNA, DNase, RNase and PCR inhibitors<sup>1)</sup>

<sup>1)</sup> Download of certificates under [www.eppendorf.com/certificates](http://www.eppendorf.com/certificates)

#### Ordering information

Description	Order no.
<b>Eppendorf PCR Tubes, 0.5 mL, PCR clean, with hinged lid, clear, 500 pcs.</b>	0030 124.537

i For more information go to [www.eppendorf.com/pcr](http://www.eppendorf.com/pcr)

## Cap Strips



### Cap Strips

- > Strips with eight microcaps for 0.1 and 0.2 mL wells
- > Easy and rapid sealing of Eppendorf twin.tec PCR Plates, PCR strips and other standard multiwell plates
- > Flat Cap Strips are suitable for real-time PCR
- > Autoclavable (121 °C, 20 min)

#### Ordering information

Description	Order no.
<b>Cap Strips, 8-strips</b>	
domed, 120 pcs. (10 × 12 pcs.)	0030 124.839
flat, 120 pcs. (10 × 12 pcs.)	0030 124.847

## Masterclear® Cap Strips and *real-time* PCR Tube Strips



### Masterclear® Cap Strips and *real-time* PCR Tube Strips

#### *real-time* PCR Tube Strips

- > White wells for better reflection
- > High mechanical stability
- > Extremely thin walls for optimal heat transfer

#### Masterclear Cap Strips

- > Inverted dome to avoid scratching of the optic surface
- > Inverted dome to reduce volume of the tubes
- > Optimized for maximum light transmission

#### Ordering information

Description	Order no.
<b><i>real-time</i> PCR Tube Strips, without caps</b>	
120 pcs. (10 × 12 pcs.)	0030 132.882
<b>Masterclear Cap Strips and <i>real-time</i> PCR Tube Strips</b>	
120 pcs. (10 × 12 pcs.)	0030 132.890
<b>Masterclear Cap Strips</b>	
120 pcs. (10 × 12 pcs.)	0030 132.874

## Heat Sealing Film and Heat Sealing Foil



### Heat Sealing Film and Heat Sealing Foil

- > Hermetic sealing of multiwell plates, especially recommended for low reaction volumes
- > Best protection against evaporation during PCR
- > Maximum adhesiveness at high temperatures during PCR

#### Ordering information

Description	Order no.
Eppendorf Heat Sealing Film, PCR clean, 100 pcs.	0030 127.838
Eppendorf Heat Sealing Foil, PCR clean, 100 pcs.	0030 127.854

## Masterclear® *real-time* PCR Film



### Masterclear® *real-time* PCR Film

- > Optimized for maximum light transmission
- > Optimized for tight sealing
- > Optimized packaging for your convenience

#### Ordering information

Description	Order no.
Masterclear® <i>real-time</i> PCR Film, self-adhesive, PCR clean, 100 pcs.	0030 132.947

## PCR Film (self-adhesive) and PCR Foil (self-adhesive)



### PCR Film (self-adhesive) and PCR Foil (self-adhesive)

- > Effective adhesive sealing prevents evaporation loss during PCR
- > Removal from the plate with no residue
- > PCR Film: Sample can be visually monitored through the transparent film
- > PCR Foil: Easily pierced
- > PCR Foil: No sticking of the pipette tip (ideal for automated systems)

#### Ordering information

Description	Order no.
Eppendorf PCR Film, self-adhesive, PCR clean, 100 pcs.	0030 127.781
Eppendorf PCR Foil, self-adhesive, PCR clean, 100 pcs.	0030 127.790

## PCR Rack



### PCR Rack

- > Rack for handling and storing tubes and plates
- > For 0.1 mL, 0.2 mL and 0.5 mL tubes, as well as 96-well plates
- > Stackable
- > Can be stored down to -90 °C
- > Autoclavable (121 °C, 20 min)

#### Ordering information

Description	Order no.
PCR Rack, 10 pcs.	0030 124.545

# Sample Handling



Eppendorf High-Efficiency ULT Freezers

Model	HEF® U410	CryoCube® F570h	CryoCube® F570hw
Page(s)	252/258	252/258	252/258
Insulation	Vacuum insulation paneling / polyurethane foam	Vacuum insulation paneling / polyurethane foam	Vacuum insulation paneling / polyurethane foam
Wall Thickness	Type C	Type C	Type C
Capacity	410 L	570 L	570 L
Number of internal doors	5	5	5
No. of shelves			
Max. racks per freezer	15	25	25
Box capacity per rack			
5 cm (2 in) tall boxes	16	16	16
7.5 cm (3 in) tall boxes	12	8	8
12.5 cm (5 in) tall boxes	8		
Box capacity per freezer			
5 cm (2 in) tall boxes	240	400	400
7.5 cm (3 in) tall boxes	180	200	200
10 cm (4 in) tall boxes	120		
Sample capacity			
5 cm (2 in) tall boxes	24,000	40,000	40,000
Dimensions (W x D x H) <sup>1)2)3)</sup>	80 x 85.2 x 193.0 cm	102.5 x 85.2 x 194 cm	102.5 x 85.2 x 194.0 cm
Dimensions internal (W x D x H)	55 x 57.5 x 126.5 cm	76.5 x 57.5 x 126.5 cm	76.5 x 57.5 x 126.5 cm
Weight w/o accessories	262 kg	296 kg	296 kg
Shipping weight	302 kg	341 kg	341 kg
Pull-down time to -85 °C/-80 °C <sup>4)</sup>	4.66 h	4.33 h	4.10 h
Noise level	53 dBA	59 dBA	56.0 dBA
Heat output	350 W	316 W	325 W
Power supply	230 V, 50 Hz	230 V, 50 Hz	230 V, 50 Hz
Power consumption Eppendorf freezer <sup>5)</sup>	8.4 kWh/day	7.6 kWh/day	7.8 kWh/day
Max. power consumption per 5 cm box <sup>5)</sup>	35 Wh/day	19 Wh/day	19.5 Wh/day
Interior	Stainless steel	Stainless steel	Stainless steel
Password protection of setpoints	yes	yes	yes
Extras	-	Automatic vent port	Automatic vent port, water-cooled
Cooling liquid	R290 / R170	R290 / R170	R290 / R170

<sup>1)</sup> Optional CO<sub>2</sub>/LN<sub>2</sub> backup systems add 8.65 cm/3.5 in to height. <sup>2)</sup> To allow for handles and hinges, add 80 mm to width of upright freezers and 110 mm to the depth of chest freezers. <sup>3)</sup> Door open adds up to 15 cm. <sup>4)</sup> Empty freezer with shelves fitted, upright freezers only, pull down from 21 – 23 °C ambient conditions. <sup>5)</sup> Empty freezer with shelves fitted, upright freezers only, set point -80 °C, 20 – 23 °C ambient conditions.

i For more information go to [www.eppendorf.com](http://www.eppendorf.com)

Technical specifications subject to change.



Model	CryoCube® FC660h	CryoCube® F740i/iw, 3 c./ CryoCube® F740i/iw, 5 c.	CryoCube® F740hi/hiw, 3 c./ CryoCube® F740hi/hiw, 5 c.
Page(s)	252/258	252/258	252/258
Insulation	Vacuum insulation paneling / polyurethane foam	Vacuum insulation paneling / polyurethane foam	Vacuum insulation paneling / polyurethane foam
Wall Thickness	Type C	Type B	Type B
Capacity	660 L	740 L	740 L
Number of internal doors	N/A	3	3
No. of shelves	40	3/5	3/5
Max. racks per freezer		18/30	18/30
Box capacity per rack			
5 cm (2 in) tall boxes	13	32/16	32/16
7.5 cm (3 in) tall boxes	9	20/8	20/8
12.5 cm (5 in) tall boxes	6	12	12
Box capacity per freezer			
5 cm (2 in) tall boxes	520	576/528	576/528
7.5 cm (3 in) tall boxes	360	360/288	360/288
10 cm (4 in) tall boxes	240	288/264	288/264
Sample capacity			
5 cm (2 in) tall boxes	52,000	57,800/57,600/52,800	57,600/52,800
Dimensions (W x D x H) <sup>1)2)3)</sup>	207 x 84 x 107.5 cm	109.9 x 98 x 197.3 cm	109.9 x 98 x 197.3 cm
Dimensions internal (W x D x H)	147 x 59 x 76 cm	86.5 x 62.1 x 139 cm	86.5 x 62.1 x 139 cm
Weight w/o accessories	304 kg	322 kg/327 kg/328 kg/333 kg	315 kg/320 kg/333 kg/328 kg
Shipping weight	379 kg	371 kg/376 kg/377 kg/382 kg	364 kg/369 kg/382 kg/377 kg
Pull-down time to -85 °C/-80 °C <sup>4)</sup>	3.66 h	5.5 h	5.5 h
Noise level	58.3 dBA	41.3 dB	41.3 dB
Heat output	338 W	538 W	438 W
Power supply	230 V, 50 Hz	100 – 230 V, 50/60 Hz	100 – 230 V, 50/60 Hz
Power consumption Eppendorf freezer <sup>5)</sup>	8.1 kWh/day	12.9 kWh/day	10.5 kWh/day
Max. power consumption per 5 cm box <sup>5)</sup>	15.6 Wh/day	22 Wh/day/24 Wh/day	18 Wh/day/20 Wh/day
Interior	Stainless steel	Stainless steel	Stainless steel
Password protection of setpoints	yes	yes	yes
Extras	30 mm thick inner lids for temp uniformity	Automatic vent port	Automatic vent port
Cooling liquid	R290 / R170	R404A / R508B	R290 / R170

**epServices**  
for premium performance

On page 374 you will find detailed information on services for these products!

Your local distributor: [www.eppendorf.com/contact](http://www.eppendorf.com/contact)  
Eppendorf AG · Barkhausenweg 1 · 22339 Hamburg · Germany · [eppendorf@eppendorf.com](mailto:eppendorf@eppendorf.com) · [www.eppendorf.com](http://www.eppendorf.com)



Eppendorf Innova® ULT Freezers

Model	Innova® U101	Innova® U360
Page(s)	254/259	254/259
Insulation	Vacuum insulation paneling / polyurethane foam	Vacuum insulation paneling / polyurethane foam
Wall Thickness	Type B	Type B
Capacity	101 L	360 L
Number of internal doors	2	3
No. of shelves	2	3
Max. racks per freezer	6	9
Box capacity per rack		
5 cm (2 in) tall boxes	10	28
7.5 cm (3 in) tall boxes	6	20
12.5 cm (5 in) tall boxes	4	12
Box capacity per freezer		
5 cm (2 in) tall boxes	60	252
7.5 cm (3 in) tall boxes	36	180
10 cm (4 in) tall boxes	24	108
Sample capacity		
5 cm (2 in) tall boxes	6,000	25,200
Dimensions (W x D x H) <sup>1)2)3)</sup>	90 x 56.6 x 83 cm	67 x 86.7 x 195 cm
Dimensions internal (W x D x H)	48 x 33 x 64 cm	44 x 61.5 x 136.5 cm
Weight w/o accessories	116 kg	230 kg
Shipping weight	141 kg	266 kg
Pull-down time to -85 °C/-80 °C <sup>4)</sup>	3.7 h	5.6 h
Noise level	55 dBA	56 dBA
Heat output	310 W	445 W
Power supply	230 V, 50 Hz	230 V, 50 Hz
Power consumption Eppendorf freezer <sup>5)</sup>	7.4 kWh/day	10.7 kWh/day
Max. power consumption per 5 cm box <sup>5)</sup>	123.3 Wh/day	42.5 Wh/day
Interior	Stainless steel	Stainless steel
Password protection of setpoints	yes	yes
Extras	Stackable, fits below bench	-
Cooling liquid	R404A / R508B	R404A / R508B

<sup>1)</sup> Optional CO<sub>2</sub>/LN<sub>2</sub> backup systems add 8.65 cm/3.5 in to height. <sup>2)</sup> To allow for handles and hinges, add 80 mm to width of upright freezers and 110 mm to the depth of chest freezers. <sup>3)</sup> Door open adds up to 15 cm. <sup>4)</sup> Empty freezer with shelves fitted, upright freezers only, pull down from 21 – 23 °C ambient conditions. <sup>5)</sup> Empty freezer with shelves fitted, upright freezers only, set point -80 °C, 20 – 23 °C ambient conditions.

i For more information go to [www.eppendorf.com](http://www.eppendorf.com)

Technical specifications subject to change.



Model	Innova® U535	Innova® C585	Innova® C760
Page(s)	254/259	254/259	254/259
Insulation	Vacuum insulation paneling / polyurethane foam	Vacuum insulation paneling / polyurethane foam	Vacuum insulation paneling / polyurethane foam
Wall Thickness	Type B	Type B	Type B
Capacity	535 L	585 L	760 L
Number of internal doors	3	N/A	N/A
No. of shelves	3	N/A	N/A
Max. racks per freezer	12	32	44
Box capacity per rack			
5 cm (2 in) tall boxes	28	13	13
7.5 cm (3 in) tall boxes	20	9	9
12.5 cm (5 in) tall boxes	12	6	6
Box capacity per freezer			
5 cm (2 in) tall boxes	336	416	572
7.5 cm (3 in) tall boxes	240	288	396
10 cm (4 in) tall boxes	144	192	264
Sample capacity			
5 cm (2 in) tall boxes	33,600	41,600	57,200
Dimensions (W x D x H) <sup>1)2)3)</sup>	80 x 86.7 x 195 cm	169 x 78.5 x 109.2 cm	205 x 78.5 x 109.2 cm
Dimensions internal (W x D x H)	64 x 61.5 x 136.5 cm	120 x 62.5 x 78 cm	156 x 62.5 x 78 cm
Weight w/o accessories	250 kg	240 kg	285 kg
Shipping weight	296 kg	310 kg	358 kg
Pull-down time to -85 °C/-80 °C <sup>4)</sup>	5.9 h	4.5 h	5.8 h
Noise level	56 dBA	56 dBA	58 dBA
Heat output	550 W	567 W	667 W
Power supply	230 V, 50 Hz	230 V, 50 Hz	230 V, 50 Hz
Power consumption Eppendorf freezer <sup>5)</sup>	13.2 kWh/day	13.6 kWh/day	16 kWh/day
Max. power consumption per 5 cm box <sup>5)</sup>	39.3 Wh/day	32.7 Wh/day	28 Wh/day
Interior	Stainless steel	Stainless steel	Stainless steel
Password protection of setpoints	yes	yes	yes
Extras	-	30 mm thick inner lids for temp uniformity	30 mm thick inner lids for temp uniformity
Cooling liquid	R404A / R508B	R404A / R508B	R404A / R508B

**epServices** for premium performance On page 374 you will find detailed information on services for these products!

Your local distributor: [www.eppendorf.com/contact](http://www.eppendorf.com/contact)  
Eppendorf AG · Barkhausenweg 1 · 22339 Hamburg · Germany · [eppendorf@eppendorf.com](mailto:eppendorf@eppendorf.com) · [www.eppendorf.com](http://www.eppendorf.com)



Eppendorf ULT Freezers

Model	Premium U410	CryoCube® F570
Page(s)	256/259	256/259
Insulation	Polyurethane foam	Polyurethane foam
Wall Thickness	Type A	Type A
Capacity	410 L	570 L
Number of internal doors	5	5
No. of shelves	5	5
Max. racks per freezer	15	25
Box capacity per rack		
5 cm (2 in) tall boxes	16	16
7.5 cm (3 in) tall boxes	12	8
12.5 cm (5 in) tall boxes	8	
Box capacity per freezer		
5 cm (2 in) tall boxes	240	400
7.5 cm (3 in) tall boxes	180	200
10 cm (4 in) tall boxes	120	200
Sample capacity		
5 cm (2 in) tall boxes	24,000	40,000
Dimensions (W x D x H) <sup>1)2)3)</sup>	80 x 85.2 x 193 cm	102.5 x 85.2 x 194 cm
Dimensions internal (W x D x H)	55 x 57.5 x 126.5 cm	76.5 x 57.5 x 126.5 cm
Weight w/o accessories	235 kg	270 kg
Shipping weight	280 kg	315 kg
Pull-down time to -85 °C/-80 °C <sup>4)</sup>	5.6 h	5.10 h
Noise level	58.8 dBA	59.5 dBA
Heat output	448 W	438 W
Power supply	230 V, 50 Hz	230 V, 50 Hz
Power consumption Eppendorf freezer <sup>5)</sup>	10.8 kWh/day	10.5 kWh/day
Max. power consumption per 5 cm box <sup>5)</sup>	45 Wh/day	26.3 Wh/day
Interior	Stainless steel	Stainless steel
Password protection of setpoints	yes	yes
Extras	-	Automatic vent port
Cooling liquid	R404A / R508B	R404A / R508B

<sup>1)</sup> Optional CO<sub>2</sub>/LN<sub>2</sub> backup systems add 8.65 cm/3.5 in to height. <sup>2)</sup> To allow for handles and hinges, add 80 mm to width of upright freezers and 110 mm to the depth of chest freezers. <sup>3)</sup> Door open adds up to 15 cm. <sup>4)</sup> Empty freezer with shelves fitted, upright freezers only, pull down from 21 – 23 °C ambient conditions. <sup>5)</sup> Empty freezer with shelves fitted, upright freezers only, set point -80 °C, 20 – 23 °C ambient conditions.



Model	CryoCube® F740, 3 c./CryoCube® F740, 5 c.	CryoCube® FC660
Page(s)	256/259	256/259
Insulation	Vacuum insulation paneling / polyurethane foam	Polyurethane foam
Wall Thickness	Type B	Type A
Capacity	740 L	660 L
Number of internal doors	3	
No. of shelves	3/5	N/A
Max. racks per freezer	18/30	40
Box capacity per rack		
5 cm (2 in) tall boxes	32/16	13
7.5 cm (3 in) tall boxes	20/8	9
12.5 cm (5 in) tall boxes	12/8	6
Box capacity per freezer		
5 cm (2 in) tall boxes	576/528	520
7.5 cm (3 in) tall boxes	360/288	360
10 cm (4 in) tall boxes	288/264	240
Sample capacity		
5 cm (2 in) tall boxes	57,600/52,800	52,000
Dimensions (W x D x H) <sup>1)2)3)</sup>	109.9 x 91.5 x 197.3 cm	207 x 84 x 107.5 cm
Dimensions internal (W x D x H)	86.5 x 62.1 x 139 cm	147 x 59 x 76 cm
Weight w/o accessories	308 kg/317 kg	280 kg
Shipping weight	357 kg/366 kg	328 kg
Pull-down time to -85 °C/-80 °C <sup>4)</sup>	5.5 h	4.4 h
Noise level	47.8 dB	58.9 dBA
Heat output	538 W	440 W
Power supply	100 – 230 V, 50/60 Hz	230 V, 50 Hz
Power consumption Eppendorf freezer <sup>5)</sup>	12.9 kWh/day	10.6 kWh/day
Max. power consumption per 5 cm box <sup>5)</sup>	22 Wh/day/24 Wh/day	20.4 Wh/day
Interior	Stainless steel	Stainless steel
Password protection of setpoints	yes	yes
Extras	Automatic vent port	30 mm thick inner lids for temp uniformity
Cooling liquid	R404A / R508B	R404A / R508B



On page 374 you will find detailed information on services for these products!

i For more information go to [www.eppendorf.com](http://www.eppendorf.com)

# Eppendorf High-Efficiency ULT Freezers

## Description

For Eppendorf, being efficient and green is not a trend, it's in our nature. Since 1945 we have recognized our place as a global citizen and began our green initiative by building high-quality, long-lasting products. Today, we continue to set new standards with our high-efficiency freezers, among the most energy-efficient ULT freezers on the market. Eppendorf High-Efficiency ULT Freezers minimize operating costs while providing excellent protection for your critical samples. They reduce energy consumption by up to 50 % when compared to other models. This group of freezers provides all of the features of the other freezer models.



### Product features

- > Broad range of capacity classes: 410 L to 740 L, e.g. from 24,000 to 57,600 samples
- > Efficient insulation, composed of traditional insulation, vacuum insulation panels, and Vacupor® NT technology achieve energy savings
- > Efficient compressor control system reduces cycle times to lower energy consumption and increases freezer longevity
- > New automatic vent port on front door of upright CryoCube models improves energy consumption and enables fast sample access
- > Lockable main switch to prevent switch-offs by accident
- > Location for chart recorder for data documentation
- > Ergonomic door handle of CryoCube models based on Eppendorf PhysioCare Concept requires less force and provides easier access
- > Some models are available as air-cooled as well as water-cooled for further energy saving
- > Full stainless steel interior for easy cleaning during maintenance and defrost cycles; powder-coated steel exterior



- > This icon tags devices that are connectable to the Eppendorf VisioNize® system. Further information are available at pages 12 – 13.



CryoCube® F740 "i" versions: Electronic lock for access control



Automatic vent port for easy re-access to samples at upright CryoCubes

### Environmentally friendly and energy efficient

Ultra-low temperature freezers traditionally consume a large amount of energy, as they maintain extremely low temperatures 24/7. With today's high energy costs and focus on the environment, energy conservation has become even more important in the lab. Eco-friendly Eppendorf ULT freezers are designed to help you save energy without compromising sample security.

- > A highly efficient compressor control system reduces cycling times to lower energy consumption and increase freezer longevity
- > Low noise levels and heat output to benefit your work environment
- > High-quality insulation materials and gaskets provide ultimate temperature control and optimized energy efficiency
- > Environmentally safe, HCFC-free and CFC-free refrigerants minimize greenhouse gases ("h" versions)
- > Biodegradable and commercially-available, high-performance, synthetic compressor lubricants prevent "oil-logging"
- > A single, quiet, condenser fan reduces energy consumption; compared to many freezers that require two
- > Built with 95 – 98 % recyclable materials (by weight)



Eppendorf CryoCube F740: Rear panel for sound reduction at "i" versions



Eppendorf ULT freezers: Secured access to avoid accidental power-off of freezer

### Less Power Consumption. Smaller Carbon Footprint. Save using Eppendorf Freezers.

	Capacity	Power consumption Eppendorf freezer	Power consumption competitor's freezer	Power saving with Eppendorf freezer
Premium U410, 50 Hz	410 L	10.8 kWh/day	15.3 kWh/day	4.5 kWh/day
HEF® U410, 50 Hz	410 L	8.4 kWh/day	15.3 kWh/day	6.7 kWh/day
CryoCube® F570h, 50 Hz	570 L	7.6 kWh/day	14.9 kWh/day	7.3 kWh/day
CryoCube® F740hi, 50/60 Hz	740 L	10.5 kWh/day	17.0 kWh/day	6.5 kWh/day

<sup>1)</sup> According to the European Commission eurostat. <sup>2)</sup> Electricity sources in Europe emit 352 g CO<sub>2</sub> per kWh, according to the International Energy Agency, IEA.

Average cost per kWh <sup>1)</sup>	Eppendorf energy savings over 10 years	Energy savings for every 25 units over 10 years	Reduction in CO <sub>2</sub> emission tons over 10 years <sup>2)</sup>
0.22 €	3,613 €	90,337 €	5.8 t
0.22 €	5,540 €	138,517 €	8.8 t
0.22 €	5,861 €	146,547 €	9.4 t
0.22 €	5,220 €	130,488 €	8.4 t

ULT-FREEZERS

ULT-FREEZERS

# Eppendorf Innova® ULT Freezers

## Description

When it comes to maximizing sample storage capacity, Eppendorf Innova ULT Freezers set the standard. They take advantage of ultra-efficient, ultra-compact vacuum insulation panels which are used in combination with traditional insulation to slim down the freezer wall thickness from 130 mm to 80 mm. These models are ideal for labs short on space. The following models are offered: U101, U360, U535, C585, and C760.



## Product features

- > Vacuum insulation panels allow for increased internal capacity with the same footprint as traditionally foamed freezers
- > Inner doors are gasketed as well as insulated creating 3 separate compartments minimizing cold air loss while you access your samples
- > Easy-to-read, eye level, flush mounted LED control panel and alarm status
- > Each shelf is adjustable in height for additional storage flexibility
- > Special vacuum vent with plunger ergonomically located at waist level to gain immediate access to your freezer
- > Inner doors can be quickly removed without the need for tools for easier and faster defrosting
- > Full stainless steel interior for easy cleaning during maintenance and defrost cycles; powder-coated steel exterior
- > Special low-temperature outer door seals allow gaskets to remain flexible at -86 °C and prevent ice buildup for easy access to samples
- > Password protection of alarm and temperature setpoints to prevent unauthorized setting changes



Sample storage in drawer racks - easy access to sample tubes and stable freezer boxes for safe tube storage



Air filter: Quick release fixation of grid for easy access and cleaning



Air vent port easy to access to enable fast re-opening of freezer



The Eppendorf Innova ULT freezer U101: A personal sized upright freezer that packs all of the features of our full uprights into one small package



30 mm thick inner lids, constructed from molded insulation, help maintain temperature stability



Inner doors can easily be removed for good access to compartment during cleaning of freezer

For more information go to [www.eppendorf.com](http://www.eppendorf.com)



# Eppendorf ULT Freezers

## Description

Eppendorf ULT Freezers are known for their energy efficiency, reliability, and worry-free, long-term sample preservation. They provide many of the same features as our Innova ULT Freezers, but are conventionally insulated for a cost-effective alternative. Polyurethane insulation combined with a highly efficient cooling system achieve and maintain ultra-low temperatures of -86 °C.

## Product features

- > Traditionally foamed polyurethane insulation enforced by vacuum insulation panels in freezer body provides efficient insulation protection\*
- > Quick pull-down and recovery times with reliable heavy-duty compressors for sample safety
- > Left or right-handed outer door as option for optimal space usage in the lab\*
- > Easy-to-read, eye level, flush mounted control panel and alarm status
- > Inner doors are insulated and sealed minimizing cold air loss while accessing your samples\*
- > 3 or 5 compartments as option, each accepts Eppendorf racks as well as other popular brands without adjustment\*
- > Each shelf has air slits for fast temperature adaption\*
- > Special low-temperature outer door seals allow gaskets to remain flexible at -86 °C and prevents ice buildup
- > Full stainless steel interior for easy cleaning during maintenance and defrost cycles; powder-coated steel exterior

\*CryoCube F740 only



**F740: 3 compartment version stainless steel interior**

For more information go to [www.eppendorf.com](http://www.eppendorf.com)



Less force needed? New door handle design based on Eppendorf PhysioCare® Concept to enable easy access (limited to upright Eppendorf CryoCubes)



Automatic vent port on front door enables fast sample access



Flat and flexible sealing at outer door to optimize insulation



Two access ports allow CO<sub>2</sub>/LN<sub>2</sub> injection or addition of probes



Inner door sealing for energy saving (CryoCube F740 series)



New air filter system of CryoCube F740 series for noise reduction

## Eppendorf High-Efficiency ULT Freezers

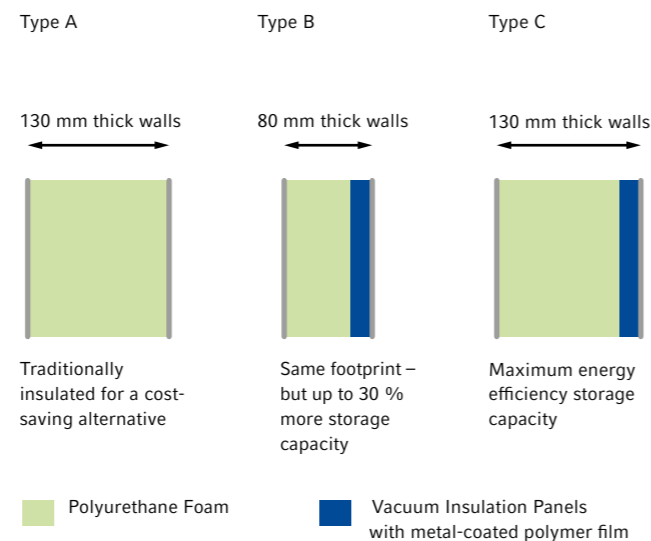

### Ordering information

Description	Order no.
CryoCube® FC660h, 660 L, 230 V/50 Hz	F660320001
HEF® U410, 410 L, 5 shelves, 230 V/50 Hz	U9260-0008
CryoCube® F570h, 570 L, 5 shelves, 230 V/50 Hz	F570320001
CryoCube® F570hw, 570 L, 5 shelves, 230 V/50 Hz	F570320101
CryoCube® F740i, 740 L, left, 3 shelves, 230 V/50 Hz	F740310011
CryoCube® F740i, 740 L, left, 5 shelves, 230 V/50 Hz	F740310031
CryoCube® F740i, 740 L, right, 3 shelves, 230 V/50 Hz	F740310021
CryoCube® F740i, 740 L, right, 5 shelves, 230 V/50 Hz	F740310041
CryoCube® F740hi, 740 L, left, 3 shelves, 230 V/50 Hz	F740320011
CryoCube® F740hi, 740 L, left, 5 shelves, 230 V/50 Hz	F740320031
CryoCube® F740hi, 740 L, right, 3 shelves, 230 V/50 Hz	F740320021
CryoCube® F740hi, 740 L, right, 5 shelves, 230 V/50 Hz	F740320041
CryoCube® F740iw, 740 L, left, 3 shelves, 230 V/50 Hz	F740310111
CryoCube® F740iw, 740 L, left, 5 shelves, 230 V/50 Hz	F740310131
CryoCube® F740hiw, 740 L, left, 3 shelves, 230 V/50 Hz	F740320111
CryoCube® F740hiw, 740 L, left, 5 shelves, 230 V/50 Hz	F740320131
CO <sub>2</sub> back-up system, 230 V/50 Hz, CryoCube® F570 series, CryoCube FC660 series, Premium, and HEF®	U9043-0008
LN <sub>2</sub> back-up system, 230 V/50 Hz, CryoCube® F570 series, CryoCube FC660 series, Premium, and HEF®	U9044-0008
CO <sub>2</sub> back-up system, 230 V/50 Hz, Innova®, Green „G“, and CryoCube 740 series, („narrow“)	U9043-0004
LN <sub>2</sub> back-up system, 230 V/50 Hz, Innova®, Green „G“, and CryoCube 740 series, („narrow“)	U9044-0004

For racks please check page 262

For more information go to [www.eppendorf.com](http://www.eppendorf.com)

## Eppendorf Innova® ULT Freezers

### Ordering information

Description	Order no.
Innova® U101, 101 L, 2 shelves, 230 V/50 Hz	U9420-0001
Innova® U360, 360 L, 3 shelves, 230 V/50 Hz	U9425-0001
Innova® U535, 535 L, 3 shelves, 230 V/50 Hz	U9430-0001
Innova® C585, 585 L, 230 V/50 Hz	U9400-0001
Innova® C760, 760 L, 230 V/50 Hz	U9410-0001
Extra shelf for Innova® U101, U101	P0625-0180
CO <sub>2</sub> back-up system, 230 V/50 Hz, Innova®, Green „G“, and CryoCube 740 series, („narrow“)	U9043-0004
LN <sub>2</sub> back-up system, 230 V/50 Hz, Innova®, Green „G“, and CryoCube 740 series, („narrow“)	U9044-0004

For racks please check page 262

## Eppendorf ULT Freezers

### Ordering information

Description	Order no.
CryoCube® FC660, 660 L, 230 V/50 Hz	F660300001
CryoCube® F570, 570 L, 5 shelves, 230 V/50 Hz	F570300001
Premium U410, 410 L, 5 shelves, 230 V/50 Hz	U9260-0001
CryoCube® F740, 740 L, left, 3 shelves, 230 V/50 Hz	F740300011
CryoCube® F740, 740 L, left, 5 shelves, 230 V/50 Hz	F740300031
CryoCube® F740, 740 L, right, 3 shelves, 230 V/50 Hz	F740300021
CryoCube® F740, 740 L, right, 5 shelves, 230 V/50 Hz	F740300041
CO <sub>2</sub> back-up system, 230 V/50 Hz, CryoCube® F570 series, CryoCube FC660 series, Premium, and HEF®	U9043-0008
LN <sub>2</sub> back-up system, 230 V/50 Hz, CryoCube® F570 series, CryoCube FC660 series, Premium, and HEF®	U9044-0008
CO <sub>2</sub> back-up system, 230 V/50 Hz, Innova®, Green „G“, and CryoCube 740 series, („narrow“)	U9043-0004
LN <sub>2</sub> back-up system, 230 V/50 Hz, Innova®, Green „G“, and CryoCube 740 series, („narrow“)	U9044-0004

For racks please check page 262

Ordering information for other voltage options begins on page 434

## Freezers Accessories and Replacement Parts



### Eppendorf TCA-3 Temperature Monitor

- > Receive email, voicemail (country dependent), and text alarms (country dependent) if the temperature exceeds desired levels for higher sample safety
- > Quick installation on any freezer regardless of manufacturer for flexible usage
- > View temperature data readings, graphs, and statistics from any web browser for flexible data access
- > Temperature range is from -100 °C to 100 °C

#### Ordering information

Description	Order no.
<b>Eppendorf TCA-3 Temperature Monitor</b>	
230 V/50 Hz	P0625-2050



### Chart Recorder

- > Includes chart recorder, RTD probe, keys, chart recorder paper, and chart recorder pens
- > Will continuously monitor and record freezer temperature for data documentation
- > Front mounted to your freezer for easy access and can be fitted to all freezer models
- > Type I: Battery powered, will provide a minimum of eighteen months of operation
- > Type II: ULT freezer powered with backup battery (CryoCube F740 series)
- > Can be factory installed with your freezer order at no additional charge or retrofitted on location
- > Selectable temperature range (0 to -50 °C and -50 to -100 °C) and rotation speed
- > User configurable built in high and low temperature alarms

#### Ordering information

Description	Order no.
<b>Chart Recorder (Type I)</b>	P0625-2100
<b>Chart Recorder (Type II) (100 – 120V)</b>	F652999001
<b>Chart Recorder (Type II) (208 – 230V)</b>	F652999002
<b>Chart Recorder pens (Type I), 3 pk</b>	K0660-0051
<b>Chart Recorder pens (Type II), 3 pcs.</b>	F652999004
<b>Chart Recorder paper (Type I), 0 to -50 °C</b>	P0625-2111
<b>Chart Recorder paper (Type I), -50 to -100 °C</b>	P0625-2110
<b>Chart Recorder paper (Type II), 0 to -100 °C, 60 pcs.</b>	F652999003



### Padlock adaptor kit

- > Allows a user-supplied padlock to be added to the freezer's outer handle for extra security
- > Available for upright models only
- > Available for Innova®, Premium, CryoCube® F570 series, HEF, and G

#### Ordering information

Description	Order no.
<b>Padlock adaptor kit, for CryoCube® 570 series</b>	F651570003
<b>Padlock adapter kit, for all upright ULT freezers besides CryoCube® models</b>	P0625-1170



### CO<sub>2</sub> and LN<sub>2</sub> Back-up System

- > Equipped with a battery back-up to temporarily protect the contents of your freezer in case of power failure
- > Available in either liquid CO<sub>2</sub> and LN<sub>2</sub>. Liquid CO<sub>2</sub> can maintain temperatures between -50 °C and -70 °C, where as LN<sub>2</sub> can go down to -85 °C
- > Both systems can be factory installed with your freezer order or retrofitted on location
- > Info: CO<sub>2</sub> and LN<sub>2</sub> are not interchangeable systems

#### Ordering information

Description	Order no.
<b>CO<sub>2</sub> back-up system, 230 V/50 Hz, CryoCube® F570 series, CryoCube FC660 series, Premium, and HEF®</b>	U9043-0008
<b>LN<sub>2</sub> back-up system, 230 V/50 Hz, CryoCube® F570 series, CryoCube FC660 series, Premium, and HEF®</b>	U9044-0008
<b>CO<sub>2</sub> back-up system, 230 V/50 Hz, Innova®, Green „G“, and CryoCube 740 series, („narrow“)</b>	U9043-0004
<b>LN<sub>2</sub> back-up system, 230 V/50 Hz, Innova®, Green „G“, and CryoCube 740 series, („narrow“)</b>	U9044-0004

# Freezer Racks

## Description

### Drawer or side access?

When using racks with drawers, only the drawer with the freezer boxes of interest is pulled out. All other boxes stay in the cold inner area of the ULT freezer. Eppendorf drawers are optimized for smooth movement at -80 °C for ergonomic handling. When using side access racks, most of the storage boxes have to be pulled out of the cold inner area of the ULT freezer to access the samples. Racks for chest freezers can be equipped with locking rods to secure freezer boxes when pulling out the rack tower.



### Stainless steel or aluminum?

By standard, there are two types of rack materials available.

#### Stainless steel:

- > Stable/robust for longevity and higher capacity
- > For freezer boxes up to 136 mm x 136 mm for high flexibility regarding boxes
- > Special design for optimized cooling conditions and improved sample safety

#### Aluminum:

- > For freezer boxes up to 133 mm x 133 mm
- > Non-corrosive anodized aluminum for long-term use



Stainless steel drawer rack

Stainless steel side access rack

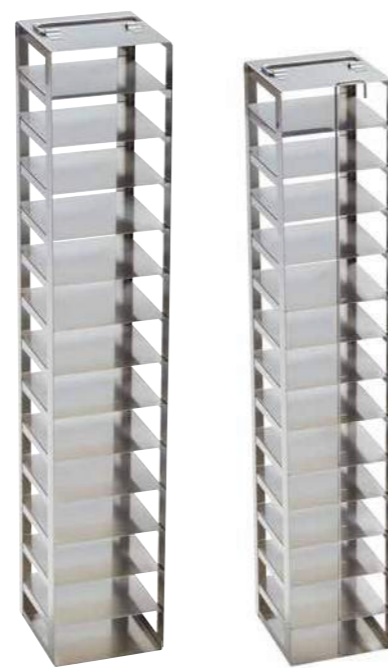

Stainless steel rack for chest freezer

Stainless steel rack for chest freezer with locking rod

## Ordering information

Description	Order no.
<b>Freezer Rack: Innova® U101</b>	
2 in or 53 mm, drawer, stainless steel	6001 062.210
2.5 in or 64 mm, drawer, stainless steel	6001 062.910
3 in or 76 mm, drawer, stainless steel	6001 062.310
4 in or 102 mm, drawer, stainless steel	6001 062.410
5 in or 127 mm, drawer, stainless steel	6001 062.510
2 in or 53 mm, side access, stainless steel	6001 061.210
2.5 in or 64 mm, side access, stainless steel	6001 061.910
3 in or 76 mm, side access, stainless steel	6001 061.310
4 in or 102 mm, side access, stainless steel	6001 061.410
5 in or 127 mm, side access, stainless steel	6001 061.510
<b>Freezer Rack: Innova® U360, U535, U725, U725-G, CryoCube F740 series (3-compartment, Standard)</b>	
2 in or 53 mm, drawer, stainless steel	6001 012.210
2.5 in or 64 mm, drawer, stainless steel	6001 012.910
3 in or 76 mm, drawer, stainless steel	6001 012.310
4 in or 102 mm, drawer, stainless steel	6001 012.410
5 in or 127 mm, drawer, stainless steel	6001 012.510
2 in or 53 mm, side access, stainless steel	6001 011.210
2.5 in or 64 mm, side access, stainless steel	6001 011.910
3 in or 76 mm, side access, stainless steel	6001 011.310
4 in or 102 mm, side access, stainless steel	6001 011.410
5 in or 127 mm, side access, stainless steel	6001 011.510
DWP (53 mm), side access, stainless steel	6001 011.110
<b>Freezer Rack: Premium® U410, U700, HEF® U410, CryoCube® F570 series, CryoCube F740 series (5-compartment, compartment 1-4)</b>	
2 in or 53 mm, drawer, stainless steel	6001 022.210
2.5 in or 64 mm, drawer, stainless steel	6001 022.910
3 in or 76 mm, drawer, stainless steel	6001 022.310
4 in or 102 mm, drawer, stainless steel	6001 022.410
2 in or 53 mm, side access, stainless steel	6001 021.210
2.5 in or 64 mm, side access, stainless steel	6001 021.910
3 in or 76 mm, side access, stainless steel	6001 021.310
4 in or 102 mm, side access, stainless steel	6001 021.410
DWP (53 mm), side access, stainless steel	6001 021.110
<b>Freezer Rack: Innova® C580, C760, CryoCube® FC660 series</b>	
2.5 in or 64 mm, side access, stainless steel	6001 000.910
3 in or 76 mm, side access, stainless steel	6001 000.310
4 in or 102 mm, side access, stainless steel	6001 000.410
5 in or 127 mm, side access, stainless steel	6001 000.510
locking rod, 2.5 in or 64 mm, side access, stainless steel	6001 000.911
locking rod, 3 in or 76 mm, side access, stainless steel	6001 000.311
locking rod, 4 in or 102 mm, side access, stainless steel	6001 000.411
<b>Freezer Rack: CryoCube® FC660 series</b>	
2 in or 53 mm, side access, stainless steel	6001 050.210
DWP (53 mm), side access, stainless steel	6001 050.110
MTP, side access, stainless steel	6001 050.010
locking rod, 2 in or 53 mm, side access, stainless steel	6001 050.211
locking rod, 2.5 in or 64 mm, side access, stainless steel	6001 000.911
locking rod, 3 in or 76 mm, side access, stainless steel	6001 000.311
locking rod, 4 in or 102 mm, side access, stainless steel	6001 000.411
locking rod, DWP (53 mm), side access, stainless steel	6001 050.111
locking rod, MTP, side access, stainless steel	6001 050.011

For more information go to [www.eppendorf.com](http://www.eppendorf.com)



# Freezer Racks

## Ordering information

Description	Order no.
<b>Freezer Rack: Innova® C580, C760</b>	
2 in or 53 mm, side access, stainless steel	6001 040.210
DWP (53 mm), side access, stainless steel	6001 040.110
MTP, side access, stainless steel	6001 040.010
locking rod, 2 in or 53 mm, side access, stainless steel	6001 040.211
locking rod, DWP (53 mm), side access, stainless steel	6001 040.111
locking rod, MTP, side access, stainless steel	6001 040.011

## Ordering information

Description	Order no.
<b>Freezer Rack: CryoCube F740 series (3-compartment, MAX)</b>	
2 in or 53 mm, side access, stainless steel	6001 071.210
2.5 in or 64 mm, side access, stainless steel	6001 071.910
3 in or 76 mm, side access, stainless steel	6001 071.310
4 in or 102 mm, side access, stainless steel	6001 071.410
5 in or 127 mm, side access, stainless steel	6001 071.510
DWP (53 mm), side access, stainless steel	6001 071.110
2 in or 53 mm, drawer, stainless steel	6001 072.210
2.5 in or 64 mm, drawer, stainless steel	6001 072.910
3 in or 76 mm, drawer, stainless steel	6001 072.310
4 in or 102 mm, drawer, stainless steel	6001 072.410
5 in or 127 mm, drawer, stainless steel	6001 072.510

## Freezer Rack: CryoCube F740 series (3-compartment, Standard)

see page 262 at Innova table



## Ordering information

Description	Order no.
<b>Freezer Rack: CryoCube F740 series (5-compartment, MAX for 5<sup>th</sup> comp.)</b>	
2 in or 53 mm, side access, stainless steel	6001 081.210
2.5 in or 64 mm, side access, stainless steel	6001 081.910
3 in or 76 mm, side access, stainless steel	6001 081.310
4 in or 102 mm, side access, stainless steel	6001 081.410
5 in or 127 mm, side access, stainless steel	6001 081.510
DWP (53 mm), side access, stainless steel	6001 081.110
2 in or 53 mm, drawer, stainless steel	6001 082.210
2.5 in or 64 mm, drawer, stainless steel	6001 082.910
3 in or 76 mm, drawer, stainless steel	6001 082.310
4 in or 102 mm, drawer, stainless steel	6001 082.410
5 in or 127 mm, drawer, stainless steel	6001 082.510

## Freezer Rack: CryoCube F740 series (5-compartment, Standard compartment 1 – 4)

see page 262 at Premium U410, CryoCube F570 table

## Ordering information

Description	Order no.
<b>Upright freezer rack: Innova® U101</b>	
10 boxes per rack, 2 in or 53 mm, drawer, aluminum	K0641-3003
6 boxes per rack, 3 in or 76 mm, drawer, aluminum	K0641-3004
4 boxes per rack, 4 in or 102 mm, drawer, aluminum	K0641-3005
<b>Chest freezer rack: Innova® C585, C760, CryoCube® FC660 series</b>	
13 boxes per rack, 2 in or 53 mm, side access, aluminum	K0641-1690
9 boxes per rack, 3 in or 76 mm, side access, aluminum	K0641-1700
6 boxes per rack, 4 in or 102 mm, side access, aluminum	K0641-1750
<b>Upright freezer rack: Innova® U360, U535, U725, U725-G</b>	
28 boxes per rack, 2 in or 53 mm, drawer, aluminum	K0641-3000
20 boxes per rack, 3 in or 76 mm, drawer, aluminum	K0641-3001
12 boxes per rack, 4 in or 102 mm, drawer, aluminum	K0641-3002
<b>Upright freezer rack: U410, HEF U410, U700, CryoCube® F570 series</b>	
16 boxes per rack, 2 in or 53 mm, drawer, aluminum	K0641-1900
12 boxes per rack, 3 in or 76 mm, drawer, aluminum	K0641-1890
8 boxes per rack, 4 in or 102 mm, drawer, aluminum	K0641-1880

# Eppendorf Storage Boxes

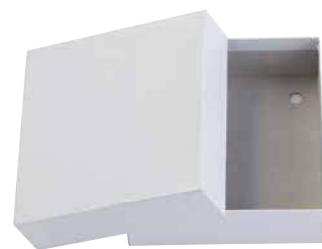

## Freezer Cardboard Storage Boxes

- > White cardboard box with water resistant coating, designed to withstand ultra-low temperature
- > Available in 53 mm (2 in), 76 mm (3 in), and 102 mm (4 in) tall boxes
- > Compatible with box dividers 7 × 7 to 10 × 10 (dividers sold separately)
- > Dimensions 133 mm

### Ordering information

Description	Order no.
<b>Freezer Cardboard Storage Boxes, white</b>	
53 mm tall	B50-SQ
76 mm tall	B75-SQ
102 mm tall	B95-SQ

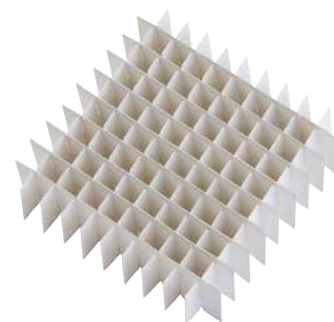

## Freezer Boxes Dividers

- > Available in 7 × 7, 8 × 8, 9 × 9 and 10 × 10 configurations
- > Compatible with freezer cardboard storage boxes (sold separately)

### Ordering information

Description	Order no.
<b>Freezer Boxes Dividers</b>	
7 × 7, 17.4 mm max. tube diameter, holds 49 tubes	D49
8 × 8, 15 mm max. tube diameter, holds 64 tubes	D64
9 × 9, 13 mm max. tube diameter, holds 81 tubes	D81
10 × 10, 11.8 mm max. tube diameter, holds 100 tubes	D100

## The Eppendorf Storage Boxes – a complete system solution for sample storage

The comprehensive modular concept allows selection of the optimal box combinations for individual storage demands. The outer footprint dimensions (133 mm) are compatible with common freezer rack systems and the different inner grid variants provide for a perfect fit to all typical tube formats: cryogenic tubes, microcentrifuge tubes, 15 and 50 mL conical tubes and other laboratory vessels. This space-saving approach together with the application benefits resulting from the listed product features help to optimize your storage and archiving of samples.



### Ordering information

Description	Order no.
<b>Storage Box 10 × 10</b> , for 100 cryogenic tubes w. int. thread, 3 pcs., height 53 mm, 2 inch, polypropylene, for freezing to -86 °C, autoclavable, with lid and alphanumeric code	0030 140.508
<b>Storage Box 9 × 9</b> , for 81 screw cap (cryog.) tubes 1 – 2 mL, 3 pcs., height 53 mm, 2 inch, polypropylene, for freezing to -86 °C, autoclavable, with lid and alphanumeric code	0030 140.516
<b>Storage Box 9 × 9</b> , for 81 screw cap (cryog.) tubes 3 mL, 2 pcs., height 76 mm, 3 inch, polypropylene, for freezing to -86 °C, autoclavable, with lid and alphanumeric code	0030 140.540
<b>Storage Box 9 × 9</b> , for 81 screw cap (cryog.) tubes 4 – 5 mL, 2 pcs., height 102 mm, 4 inch, polypropylene, for freezing to -86 °C, autoclavable, with lid and alphanumeric code	0030 140.567
<b>Storage Box 8 × 8</b> , for 64 tubes 1 – 2 mL, 3 pcs., height 53 mm, 2 inch, polypropylene, for freezing to -86 °C, autoclavable, with lid and alphanumeric code	0030 140.524
<b>Storage Box 5 × 5</b> , for 25 tubes 5 mL, 4 pcs., height 64 mm, 2.5 inch, polypropylene, for freezing to -86 °C, autoclavable, with lid and alphanumeric code	0030 140.532
<b>Storage Box 5 × 5</b> , for 25 tubes 5 mL screw cap, 2 pcs., height 76 mm, 3 inch, polypropylene, for freezing to -86 °C, autoclavable, with lid and alphanumeric code	0030 140.613
<b>Storage Box 5 × 5</b> , for 25 tubes 15 mL, 2 pcs., height 127 mm, 5 inch, polypropylene, for freezing to -86 °C, autoclavable, with lid and alphanumeric code	0030 140.583
<b>Storage Box 3 × 3</b> , for 9 tubes 50 mL and 4 tubes 15 mL, 2 pcs., height 127 mm, 5 inch, polypropylene, for freezing to -86 °C, autoclavable, with lid and alphanumeric code	0030 140.591

For more information go to [www.eppendorf.com](http://www.eppendorf.com)

# Eppendorf Eporator®

## Description

The Eppendorf Eporator is a compact instrument designed for fast and controlled electroporation of bacteria, yeasts and other microorganisms. The instrument features an intuitive operation and user-friendly programming of standard methods. Experimental data can easily be exported and documented using its USB port.



## Product features

- > Faster sample handling – simple one-button operation
- > Maximum safety via integrated cuvette holder
- > Self-explanatory operation guided by display indicators
- > Fast, freely programmable softkeys for saving and accessing the 2 most frequently used parameter settings
- > Compact, space-saving design
- > USB interface for data transfer and GLP supporting documentation

## Applications

- > Transformation of bacteria, yeast or microorganisms with an optimal transformation efficiency of approx. 5 ms time constant
- > Mainly for delivery of plasmid DNA, but also RNA, proteins and other small molecules

Technical specifications	
Model	Eporator
Interfaces	USB 2.0
Dimensions (W x D x H)	19 x 27.5 x 12.5 cm
Weight w/o accessories	3.2 kg
Capacitor	10 µF
Pulse form	Exponentially decreasing
Pulse voltage	200 – 2500 V
Resistance	600 Ohm
Special features	Electronic protective circuit to prevent arcs
Time constant	Nominal 5 ms

## Ordering information

Description	Order no.
Eppendorf Eporator®, for bacteria and yeasts, 230 V/50 – 60 Hz	4309 000.019
Cuvette stand, 24 locations, for 16 cuvettes	4308 078.006

✂ Ordering information for other voltage options begins on page 434

**epServices** for premium performance On page 378 you will find detailed information on services for these products!

Technical specifications subject to change.

# Eppendorf TransferMan® 4r

## Description

The user-friendly TransferMan 4r possesses an ergonomic and innovative design to meet the most demanding micromanipulation requirements. Smart functions, such as improved automated home function and position storage, enable simple and fast execution of even the most complex micromanipulation techniques. The DualSpeed™ joystick allows for precise and intuitive movement in all three dimensions, and dynamic movement for covering longer distances. It is ideal for manipulation of oocytes and early embryos, transfer of stem cells and microparticles, and a wide range of applications in non human reproductive biology. Application-specific user profiles simplify the individual workflow process with four pre-defined application masks to choose from (e.g., for cell transfer, DNA injection, etc). The freely programmable „My app“ mask can be optimized according to individual needs. The TransferMan 4r is for research use only.



## Applications

- > Micromanipulation of oocytes and early embryos
- > ES and iPS cell transfer
- > Nuclear transfer
- > Pronuclear and cytoplasmic injection (e.g., CRISPR/Cas, TALEN)
- > Selection of individual cells (e.g., biopsies, single cell picking)
- > Positioning and selection of microparticles
- > Microdissection of chromosomes, etc.
- > Microinjection into 3D organoids

## Product features

- > Unique DualSpeed™ joystick for precise and instantaneous movement control
- > Maximum stability ensures vibration-free work
- > One Joystick for all 3 axes (X, Y, Z) movements and in axial direction (X/Z)
- > Angle adjustment from 0° to 90°
- > One-hand operation for capillary and angle settings
- > Programmable Z-axis limit for preventing capillary breakage
- > Connection with Eppendorf PiezoXpert® and electronic microinjectors FemtoJet® 4i/4x
- > Can be adapted to all conventional microscopes
- > PC interface for remote control



[www.eppendorf.com/transferman4r-360](http://www.eppendorf.com/transferman4r-360)

## Ordering information

Description	Order no.
Eppendorf TransferMan® 4r, micromanipulator with DualSpeed™ joystick for direct and dynamic movement control, 100 – 240 V/50 – 60 Hz	5193 000.012

✂ Ordering information for other voltage options begins on page 434

Your local distributor: [www.eppendorf.com/contact](http://www.eppendorf.com/contact)  
Eppendorf AG · Barkhausenweg 1 · 22339 Hamburg · Germany · [eppendorf@eppendorf.com](mailto:eppendorf@eppendorf.com) · [www.eppendorf.com](http://www.eppendorf.com)

# Eppendorf InjectMan® 4

## Description

The InjectMan 4 is ideal for microinjection into adherent cells, smaller organisms and embryos in the early stages of development. In combination with the FemtoJet 4i or 4x, it enables fast semi-automatic injection. Furthermore, the InjectMan 4 is the ideal micromanipulator for all complex applications that require a dynamic movement mode and direct control of the injection process via the joystick button. The axial injection movement (X/Z direction) helps to minimize mechanical stress to the cells upon injection. The high penetration speed makes injection into rigid structures easier than ever. The new user interface with four pre-defined application masks facilitates the individual workflow process (e.g., for adherent cell injection, serial microinjection into fish larvae, etc.). The freely programmable „My app“ mask can be optimized for individual needs. Due to its exceptional precision and position stability, the InjectMan 4 is highly suited for applications such as patch clamp. The motor modules can be uncoupled electronically to prevent accidental movement of the micropipette. The InjectMan 4 is for research use only.



## Applications

- > Semi-automatic microinjection into adherent cells
- > Serial microinjection into fish larvae, frog eggs, insect embryos, etc.
- > Injection into living plant cells, *C. elegans* and other roundworms and flatworms
- > Automatic dispensing of cell suspensions or solutions
- > Stable, drift-free positioning, e.g. for electrophysiology techniques

## Product features

- > Maximum stability ensures drift-free work
- > Electronic coupling to FemtoJet microinjectors for fast serial semi-automatic injections with highest reproducibility
- > Selection and programming of advanced functions (e.g. axial movement, step injection)
- > Ergonomically shaped control panel for fatigue-free work
- > Easy and precise angle adjustment
- > Connection with Eppendorf PiezoXpert for piezo-assisted penetration over a pre-defined distance
- > Can be adapted to all conventional microscopes
- > PC interface for remote control



[www.eppendorf.com/injectman4-360](http://www.eppendorf.com/injectman4-360)

## Ordering information

Description	Order no.
Eppendorf InjectMan® 4, micromanipulator with dynamic movement control, 100 – 240 V/50 – 60 Hz	5192 000.019

✂ Ordering information for other voltage options begins on page 434

ℹ For more information go to [www.eppendorf.com](http://www.eppendorf.com)

Technical specifications subject to change.

Technical specifications		
Model	InjectMan 4	TransferMan® 4r
<b>Motor module set</b>		
<b>Max. traveling distance</b>	≥20 mm in X, Y, Z and X/Z direction	≥20 mm in X, Y, Z and X/Z direction
<b>Weight (complete)</b>	2.15 kg	2.15 kg
<b>Stepper motor</b>	X-, Y-, Z-module	X-, Y-, Z-module
<b>Single module (X, Y, Z)</b>		
<b>Step size</b>	<20 nm (computational resolution)	<20 nm (computational resolution)
<b>Speed</b>	0 – 10,000 µm/s	0 – 10,000 µm/s
<b>Mechanical adjustability</b>	>80 mm	>80 mm
<b>Dimensions</b>	129 x 51 x 36 mm	129 x 51 x 36 mm
<b>Weight</b>	570 g	570 g
<b>Swivel joint</b>		
<b>Direction of rotation</b>	-45° to +90°	-45° to +90°
<b>Capillary exchange</b>	Direction of rotation: forward	Direction of rotation: forward
<b>Sample replacement</b>	Direction of rotation: backward	Direction of rotation: backward
<b>Angle head</b>		
<b>Operating angle</b>	0° – 90°	0° – 90°
<b>Control board</b>		
<b>Control</b>	Joystick (dynamic kinetics)	Joystick (proportional and dynamic kinetics)
<b>Speed modes</b>	coarse, fine, x-fine	coarse, fine, x-fine
<b>External Device/PC</b>	Serial interface SUBD9, male	Serial interface SUBD9, male
<b>Dimensions (W x H x D)</b>	205 x 288 x 152 mm	205 x 288 x 152 mm
<b>Weight</b>	1.8 kg	1.8 kg

## Accessories

	Order no.
<b>Tube adapter</b> , pack of 2, for connecting tubes with an outer diameter of 2 mm or 3 mm with the capillary holder and the capillary holder 4	5194 075.407
<b>Positioning aid</b> , pack of 2, for mounting and re-positioning universal capillary holder and the capillary holder 4 on TransferMan® 4r and InjectMan® 4	5192 072.001
<b>Spare parts kit</b>	5192 071.005
<b>Headstage holder</b>	5192 073.008
<b>Y-cable PX</b> , Y-cable for connecting Eppendorf PiezoXpert® or a PC with TransferMan® 4r or InjectMan® 4 and FemtoJet® 4i/4x	5192 081.000
<b>Foot control</b> , for Eppendorf micromanipulators	5181 150.051
<b>Connection cable</b> , for connecting TransferMan® 4r/InjectMan® 4 to FemtoJet® 4i/4x	5192 082.007
<b>Connection cable</b> , for connecting Eppendorf micromanipulators with FemtoJet® and FemtoJet® express	5181 070.015
<b>Connection cable</b> , for connecting Eppendorf micromanipulators with PC or Eppendorf PiezoXpert®	5181 150.094
<b>Y-cable FJ4</b> , Y-cable for connecting FemtoJet® 4i/4x with a PC and TransferMan® 4r or InjectMan® 4	5192 080.004

Your local distributor: [www.eppendorf.com/contact](http://www.eppendorf.com/contact)

Eppendorf AG · Barkhausenweg 1 · 22339 Hamburg · Germany · [eppendorf@eppendorf.com](mailto:eppendorf@eppendorf.com) · [www.eppendorf.com](http://www.eppendorf.com)



## Microscope Adapters for Micromanipulation Systems



### Description

Eppendorf microscope adapters enable the simple installation of the TransferMan® 4r or InjectMan® 4 on all conventional inverted microscopes manufactured by Leica®, Nikon®, Olympus® and Zeiss®.



Compatible to all major microscope brands

### Ordering information

Description	Order no.
<b>Adapter Leica® 1</b> , for Eppendorf micromanipulation systems, for Leica® DMI8, DMI3000 B, 3000 M, 4000 B, 5000 B, 5000 M, 6000 B, DM IRB E, HC and DM IRE 2 microscopes	5192 301.000
<b>Adapter Leica® 2</b> , for Eppendorf micromanipulation systems, for Leica® DM IL LED and HC microscopes	5192 302.007
<b>Adapter Nikon® 1</b> , for Eppendorf micromanipulation systems, for Nikon® Eclipse® Diaphot 200, 300 and Eclipse® Ti-E, Ti-U, Ti-S, TE200, TE300, TE2000 microscopes	5192 316.008
<b>Adapter Nikon® 2</b> , for Eppendorf micromanipulation systems, for Nikon® Eclipse® Ts2R microscope	5192 317.004
<b>Adapter Nikon® 3</b> , for Eppendorf micromanipulation systems, for Nikon® Eclipse Ti2-E/-A/-U microscopes	5192 318.000
<b>Adapter Olympus® 1</b> , for Eppendorf micromanipulation systems, for Olympus® IX50, IX51, IX70, IX71, IX80 and IX81 microscopes	5192 306.002
<b>Adapter Olympus® 2</b> , for Eppendorf micromanipulation systems, for microscopes of Olympus® IX3 series with illumination column IX3-ILL	5192 307.009
<b>Adapter Olympus® 3</b> , for Eppendorf micromanipulation systems, for microscopes of Olympus® IX3 series with illumination IX2-ILL30	5192 308.005
<b>Adapter Zeiss® 1</b> , for Eppendorf micromanipulation systems, for Zeiss® Axiovert® 200, Axio Observer A1, D1, Z1 and Axio Observer 3, 5 and 7 microscopes	5192 311.006
<b>Adapter Zeiss® 2</b> , for Eppendorf micromanipulation systems, for Zeiss® Axio Vert.A1 microscope	5192 312.002
<b>Universal stand</b> , for mounting Eppendorf micromanipulators on upright microscopes and stereo microscopes independent of the microscope tripod used	5192 325.007
<b>Adapter bridge</b> , for mounting Eppendorf micromanipulators on microscope adapters for TransferMan® NK 2, InjectMan® NI 2 and PatchMan NP 2	5192 321.001



### Description

The Universal Stand can be used for mounting the TransferMan 4 and InjectMan 4 micromanipulators on upright microscopes and stereo microscopes independent of the microscope tripod used. With its magnetic foot the Universal stand can be firmly fixed to any ferromagnetic base (plate or table).

## Antivibration Pad

### Description

The antivibration pads are specifically designed to effectively protect your micromanipulation system against external vibrations. The pads are simply positioned directly under the base points of your microscope. Five different formats are available, from XS to XL. The various pads are optimized for specific weight ranges to guarantee optimal results. A selection of pads specifically chosen for each microscope ensures effective protection for your sample.

### Product features

- > Effectively protects micromanipulation workstations from external vibrations
- > Five different formats available
- > Different formats can be combined for optimal adjustment



[www.eppendorf.com/antivibrationpad-360](http://www.eppendorf.com/antivibrationpad-360)

### Ordering information

Description	Order no.
<b>Antivibration Pad XS</b> , weight range 4.5 – 6.0 kg	5181 301.009
<b>Antivibration Pad S</b> , weight range 6.0 – 8.0 kg	5181 303.001
<b>Antivibration Pad M</b> , weight range 8.0 – 10.0 kg	5181 305.004
<b>Antivibration Pad L</b> , weight range 10.0 – 12.5 kg	5181 307.007
<b>Antivibration Pad XL</b> , weight range 12.5 – 16.5 kg	5181 309.000

- It is decisive to take into account the total weight of your microscope, including the mounted accessories, and the load distribution of the individual contact points.

## Antivibration Pad

### Description

The antivibration pads are specifically designed to effectively protect your micromanipulation system against external vibrations. The pads are simply positioned directly under the base points of your microscope. Five different formats are available, from XS to XL. The various pads are optimized for specific weight ranges to guarantee optimal results. A selection of pads specifically chosen for each microscope ensures effective protection for your sample.

### Product features

- > Effectively protects micromanipulation workstations from external vibrations
- > Five different formats available
- > Different formats can be combined for optimal adjustment



[www.eppendorf.com/antivibrationpad-360](http://www.eppendorf.com/antivibrationpad-360)

### Ordering information

Description	Order no.
<b>Antivibration Pad XS</b> , weight range 4.5 – 6.0 kg	5181 301.009
<b>Antivibration Pad S</b> , weight range 6.0 – 8.0 kg	5181 303.001
<b>Antivibration Pad M</b> , weight range 8.0 – 10.0 kg	5181 305.004
<b>Antivibration Pad L</b> , weight range 10.0 – 12.5 kg	5181 307.007
<b>Antivibration Pad XL</b> , weight range 12.5 – 16.5 kg	5181 309.000

- It is decisive to take into account the total weight of your microscope, including the mounted accessories, and the load distribution of the individual contact points.

# Eppendorf PiezoXpert®

## Description

The Eppendorf PiezoXpert allows for piezo-assisted micromanipulation, enabling simple penetration of cells for microinjection or micromanipulation. Perforation of the cell membrane is supported by piezo impulses which are directly transferred to the capillary without any loss of intensity. Piezo-assisted micromanipulation improves the results of a variety of applications including transfer of embryonic or induced pluripotent stem cells into blastocysts and morulae, injection into mammalian oocytes and zygotes, and enucleation/nuclear transfer. The Eppendorf PiezoXpert forms the perfect system with Eppendorf micromanipulators, but it integrates just as easily into non-Eppendorf micromanipulation systems. The Eppendorf PiezoXpert is for research use only.



## Product features

- > Fast and simple sample processing due to intuitive operation
- > Reproducible parameter setting
- > Program keys to save your experimental parameters
- > Trigger impulses with an ergonomic foot control or rotary knobs right on the device
- > Optical feedback of triggered impulses
- > Additional „Clean“ function for simple removal of contamination on the outside of the capillary

## Applications

- > Transfer of embryonic or induced pluripotent stem cells into blastocysts or morulae
- > ICSI (Intracytoplasmic Sperm Injection) in mouse, equine, porcine etc.
- > Enucleation/nuclear transfer
- > Blastomere biopsy from mouse embryos
- > Biopsy of equine embryos for Preimplantation Genetic Diagnosis
- > RNA/DNA injection into fertilized oocytes of mammals



[www.eppendorf.com/piezoxpert-360](http://www.eppendorf.com/piezoxpert-360)

For more information go to [www.eppendorf.com](http://www.eppendorf.com)

Technical specifications	
<b>Model</b>	PiezoXpert
<b>Interfaces</b>	USB (for technical service), RS-232 (connection to foot control)
<b>Power supply</b>	100 – 240 V, 50 – 60 Hz
<b>Max. power consumption</b>	18 W
<b>Dimensions (W x D x H)</b>	17 x 23 x 11.5 cm
<b>Weight w/o accessories</b>	2.8 kg
<b>Piezo impulse</b>	
<b>Intensity (of piezo impulses)</b>	1 – 86 (1 – 22 adjustable in increments of 1, 22 – 86 adjustable in increments of 4)
<b>Number (number of piezo impulses)</b>	1 – 10, ∞ (1 – 10 adjustable in increments of 1)
<b>Speed (frequency of piezo impulses/sec)</b>	1 – 40 (1 – 40 adjustable in increments of 1, 1 – 10: 1 Hz per increment, 10 – 20: 2 Hz per increment, 20 – 34: 5 Hz per increment, 34 – 40: 25 Hz per increment)
<b>Clean function</b>	
<b>Intensity (of piezo impulses)</b>	1 – 86 (1 – 22 adjustable in increments of 1, 22 – 86 adjustable in increments of 4)
<b>Speed (frequency of piezo impulses/sec)</b>	1 – 40 (1 – 40 adjustable in increments of 1, 1 – 10: 1 Hz per increment, 10 – 20: 2 Hz per increment, 20 – 34: 5 Hz per increment, 34 – 40: 25 Hz per increment)

## Ordering information

Description	Order no.
Eppendorf PiezoXpert®, for piezo-assisted micromanipulation, incl. actuator 2, foot control and spacer plate and grip head 4 size 0, 100 – 240 V/50 – 60 Hz	5194 000.016
Actuator 2, for piezo-assisted micromanipulation, as accessory for the Eppendorf PiezoXpert	5194 075.156
Grip head set 4 size 0, for microcapillaries with outer diameter 1.0 to 1.1 mm	5196 082.001
Grip head set 4 size 1, for microcapillaries with outer diameter 1.2 to 1.3 mm	5196 083.008
Grip head set 4 size 2, for microcapillaries with outer diameter 1.4 to 1.5 mm	5196 084.004
Grip head set 4 size 3, for microcapillaries with outer diameter 0.7 to 0.9 mm	5196 085.000
Tube adapter, pack of 2, for connecting tubes with an outer diameter of 2 mm or 3 mm with the capillary holder and the capillary holder 4	5194 075.407
Piezo Drill Tip Mouse ICSI, for piezo-assisted mouse ICSI (for research use only), 25° tip angle, 6 µm inner diameter, 6 mm flange, sterile, set of 25	5195 000.087
Piezo Drill Tip ES, for piezo-assisted mouse ES cell transfer (for research use only), 25° tip angle, 15 µm inner diameter, 6 mm flange, sterile, set of 25	5195 000.095

Ordering information for other voltage options begins on page 434

## NEW - CellTram® 4r Air/Oil

### Description

The CellTram 4r Air and CellTram 4r Oil are manual microinjectors suitable for a broad range of life science applications. The CellTram 4r Air is a pneumatic injector for oil-free micromanipulation and gentle holding of cells in suspension. Due to its excellent performance, it is also highly suitable for uptake and injection of cells (e.g., of sperm or ES cells). For this application, its performance is comparable to that of oil-filled injectors. The CellTram 4r Oil is a hydraulic, oil-filled microinjector that provides more direct sample control and can generate higher pressures than an air system. It is optimized for leakage-free work and easy oil filling. Both models can be used with all common micromanipulation systems yet they develop their full potential with Eppendorf manipulators. The CellTram 4r Air/Oil injectors are for research use only.



1. Non-hydraulic system for oil-free manipulation and injection of cells (CellTram 4r Air)

2. Piston position scale enables setting of air volume and injection characteristics according to individual needs (CellTram 4r Air)

3. Improved oil-filling system for quick and clean re-filling (CellTram 4r Oil)

4. Coarse and fine drive for precise and intuitive sample control

5. Improved rotary knob design for better handling and easier cleaning

6. Capillary holder 4 with markings for easier positioning

7. New grip head 4 system for simple capillary change and higher user safety

8. Position indicators and marking for in/out to reduce risk of user errors

9. Stable, nonslip base plate

10. Highly reliable performance with minimal maintenance

i For more information go to [www.eppendorf.com](http://www.eppendorf.com)

Technical specifications subject to change.



Piston position scale indicates instrument status and allows for setting pressure characteristics according to individual needs

The new oil-filling system helps avoid oil-spilling and facilitates the filling process

### Applications

- > Mouse ICSI
- > Large mammal ICSI (e.g., equine, porcine...)
- > Piezo-assisted micromanipulation in combination with the Eppendorf PiezoXpert®
- > Transfer of cells or organelles (e.g., ES cell or iPS cell transfer into blastocysts or morulae)
- > Enucleation/nuclear transfer
- > (Xeno)transplantations
- > Removal of cells (e.g., for polar body biopsy, blastomere biopsy or trophectoderm biopsy)
- > Manual microinjection and dispensing of aqueous solutions

Technical specifications		
Model	CellTram 4r Air	CellTram 4r Oil
Cylinder volume	10 mL	1,000 µL
Max. pressure	3,000 hPa	20,000 hPa
Min. adjustable volume	<100 nL	<1.5 nL
Pressure generation	Cylinder/piston system, air-filled	Cylinder/piston system, oil-filled
Volume change per revolution	60 µL/600 µL (fine/ coarse rotary knob)	1 µL/10 µL (fine/ coarse rotary knob)

### Ordering information

Description	Order no.
CellTram® 4r Air, manual pneumatic microinjector, with gears 1:1 and 1:10, for holding and injection	5196 000.013
CellTram® 4r Oil, manual hydraulic microinjector, with gears 1:1 and 1:10, for holding and injection	5196 000.030
Capillary holder 4, for mounting microcapillaries, Femtotips, Femtotip II or grip head 4 (incl. Grip head 4 size 0 and adapter for Femtotips)	5196 081.005
Capillary holder 4 slim shape, for flat angle injections, for microcapillaries with outer diameter 1.0 mm	5196 062.000
Filling and Cleaning set, incl. filling tube, Luer lock adapter, 2 syringes for CellTram 4	5196 088.000
Grip head set 4 size 0, for microcapillaries with outer diameter 1.0 to 1.1 mm	5196 082.001
Grip head set 4 size 1, for microcapillaries with outer diameter 1.2 to 1.3 mm	5196 083.008
Grip head set 4 size 2, for microcapillaries with outer diameter 1.4 to 1.5 mm	5196 084.004
Grip head set 4 size 3, for microcapillaries with outer diameter 0.7 to 0.9 mm	5196 085.000
Injection tube Air, white ring mark, I.D. 0.5 mm, length 1.3 m	5196 061.004
Injection tube Oil, blue ring mark, I.D. 1.0 mm, length 1.3 m	5196 089.006
O-ring set 4, incl. 10 o-rings large, 10 o-rings small, 2 distance sleeves, o-ring removal tool for grip head set 4	5196 086.007

## FemtoJet® 4i and FemtoJet® 4x

### Description

Eppendorf's electronic microinjectors FemtoJet® 4i and FemtoJet® 4x with their simple operation menu and a range of functionalities are perfectly suited for injecting small to intermediate volumes. With a built-in compressor, the FemtoJet 4i is the tool of choice for injecting aqueous solutions into adherent cells and suspension cells. If your research demands injecting volumes greater than 100 pL and/or longer series at higher pressures, FemtoJet 4x with its external pressure supply (not included) delivers the precise and continuous pressure required. Featuring the same quality design and compatibility features as the FemtoJet 4i, the FemtoJet 4x is the „heavy duty“ device for those more demanding applications. Both the FemtoJet 4i and FemtoJet 4x, form the perfect system with Eppendorf micromanipulators, yet they integrate just as easily with non-Eppendorf micromanipulation systems. The electronic connection between FemtoJet 4i or 4x and TransferMan® 4r or InjectMan® 4 guarantees simple, rapid and reproducible microinjections into cells, simplifying your daily work and speeding up your workflow. The FemtoJet 4i/ 4x injectors are for research use only.



### Product features

- > Very simple and clearly arranged operation for routine tasks
- > Injection volume ranges from femtoliters to microliters
- > Inject and Clean function can be triggered right on the device using the included mouse or optional foot control
- > Programmable injection guarantees high reproducibility
- > Connection to TransferMan® 4r, InjectMan® 4 or InjectMan® NI 2 enables semi-automatic microinjection
- > Small footprint
- > Can be combined with all conventional micromanipulation systems
- > Independent pressure supply via built-in compressor (only FemtoJet 4i)
- > External pressure supply guarantees the continuous availability of higher injection pressures - even with large volumes and very short intervals (only FemtoJet 4x)



[www.eppendorf.com/femtojet-360](http://www.eppendorf.com/femtojet-360)

## Gentle treatment for your cells

Minimizing mechanical trauma to your sample is critical for achieving optimal results. The new capillary holder 4 (slim shape) in combination with Eppendorf manipulators allows for injecting with straight capillaries at angles lower than 15°. This capillary holder 4 (slim shape) can be used in combination with the FemtoJet 4 as well as with the CellTram 4r. This helps to achieve highest survival rates for your developing embryos.



For more information go to [www.eppendorf.com](http://www.eppendorf.com)

## FemtoJet® 4i



### Description

The electronic microinjector, FemtoJet 4i, with its simple operation and wide range of functionality is ideally suited for injecting small to intermediate volumes of up to 100 pL into adherent cells and suspension cells for research purposes. The FemtoJet 4i with its built-in compressor forms a perfect team with Eppendorf micromanipulators, but it integrates just as easily with non-Eppendorf micromanipulator systems. The electronic connection between FemtoJet 4i and TransferMan® 4r and InjectMan® 4 guarantees simple, rapid and reproducible microinjections into cells.

### Applications

- > Reproducible and serial microinjection into adherent cells when combined with the InjectMan® 4 or InjectMan® NI 2 micromanipulator
- > Pronuclear or cytoplasmic injection of RNA/DNA solutions into fertilized oocytes of mammals, when combined with the TransferMan® 4r micromanipulator
- > Especially well suited for injection volumes from femtoliters to 100 pL

## FemtoJet® 4x



### Description

The FemtoJet 4x is the ideal solution if your research demands injection volumes greater than 100 pL and/or longer series at higher pressures – increasingly seen in functional genomics and developmental biology applications. The FemtoJet 4x with its external pressure supply (not included) delivers the precise and continuous pressure required. Featuring the same quality design and compatibility as the FemtoJet 4i, the 4x model is the „heavy duty“ device for those more demanding applications.

### Applications

- > Microinjection into small organisms and embryos in the early stages of development (e.g., *Drosophila melanogaster*, Zebrafish, etc.)
- > Especially well suited for serial injection volumes from 100 pL to 1 µL or more

Typical Injection Volume	FemtoJet 4i		FemtoJet 4x	
Cell nucleus of adherent cells	[Bar chart showing range from 10 <sup>-15</sup> to 10 <sup>-12</sup> L]			
Cytoplasm of adherent cells		[Bar chart showing range from 10 <sup>-12</sup> to 10 <sup>-9</sup> L]		
Pronucleus of fertilized mouse oocytes			[Bar chart showing range from 10 <sup>-9</sup> to 10 <sup>-6</sup> L]	
<i>Caenorhabditis elegans</i>				[Bar chart showing range from 10 <sup>-9</sup> to 10 <sup>-6</sup> L]
Fish embryos in early development phases				[Bar chart showing range from 10 <sup>-9</sup> to 10 <sup>-6</sup> L]
<i>Xenopus laevis</i> oocytes				[Bar chart showing range from 10 <sup>-9</sup> to 10 <sup>-6</sup> L]
Volume (liter, logarithm, measurement unit)	10 <sup>-15</sup>	10 <sup>-12</sup>	10 <sup>-9</sup>	10 <sup>-6</sup>
Unit	femtoliter	picoliter	nanoliter	microliter

FemtoJet 4i is suitable for applications that require lower volume ranges; FemtoJet 4x is better suited for applications that require higher volume ranges. Both feature the same injection time and pressure parameters.

## FemtoJet® 4i and FemtoJet® 4x



Both the FemtoJet 4i and FemtoJet 4x, can easily be combined for all types of micromanipulators, yet they form the perfect system with Eppendorf micromanipulators.

Technical specifications		
Model	FemtoJet 4i	FemtoJet 4x
Dimensions (W x D x H)	21.3 x 20.7 x 25 cm	21.3 x 20.7 x 25 cm
Weight w/o accessories	5 kg	3.5 kg
Clean function	Max. 6,000 hPa (87 psi)	Max. 6,000 hPa (87 psi)
Compensation pressure	5 – 6,000 hPa (87 psi); can be set in increments of 1 hPa	5 – 6,000 hPa (87 psi); can be set in increments of 1 hPa
Injection pressure	5 – 6,000 hPa (87 psi); can be set in increments of 1 hPa	5 – 6,000 hPa (87 psi); can be set in increments of 1 hPa
Pressure supply	Integrated compressor	External pressure supply (not included)

### Ordering information

Description	Order no.
Capillary holder 4, for mounting microcapillaries, Femtotips, Femtotip II or grip head 4 (incl. Grip head 4 size 0 and adapter for Femtotips)	5196 081.005
Capillary holder 4 slim shape, for flat angle injections, for microcapillaries with outer diameter 1.0 mm	5196 062.000
Filling and Cleaning set, incl. filling tube, Luer lock adapter, 2 syringes for CellTram 4	5196 088.000
Injection tube Air, white ring mark, I.D. 0.5 mm, length 1.3 m	5196 061.004
Injection tube Oil, blue ring mark, I.D. 1.0 mm, length 1.3 m	5196 089.006
O-ring set 4, incl. 10 o-rings large, 10 o-rings small, 2 distance sleeves, o-ring removal tool for grip head set 4	5196 086.007
Y-cable PX, Y-cable for connecting Eppendorf PiezoXpert® or a PC with TransferMan® 4r or InjectMan® 4 and FemtoJet® 4i/4x	5192 081.000
Grip head set 4 size 0, for microcapillaries with outer diameter 1.0 to 1.1 mm	5196 082.001
Grip head set 4 size 1, for microcapillaries with outer diameter 1.2 to 1.3 mm	5196 083.008
Grip head set 4 size 2, for microcapillaries with outer diameter 1.4 to 1.5 mm	5196 084.004
Grip head set 4 size 3, for microcapillaries with outer diameter 0.7 to 0.9 mm	5196 085.000
Grip head set 4 (slim shape), for Capillary holder 4 slim shape incl. 6 O-rings and 2 distance sleeves, for capillaries with outer diameter 1.0 mm	5196 063.007
FemtoJet® 4i, programmable microinjector with integrated pressure supply, including foot control	5252 000.013
FemtoJet® 4x, programmable microinjector with external pressure supply (not included), including foot control	5253 000.017
Hand control, for triggering inject function	5252 070.011
Y-cable FJ4, Y-cable for connecting FemtoJet® 4i/4x with a PC and TransferMan® 4r or InjectMan® 4	5192 080.004

✂ Ordering information for other voltage options begins on page 434

## Eppendorf Microcapillaries

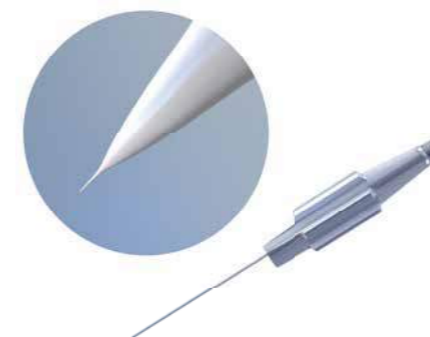

### Applications Femtotips®

- > Injection into adherent cells
- > Near-surface injection into suspension cells (e.g., into fish embryos), smaller organisms or embryos in the early stages of development

### Femtotips®

- > Defined opening with 0.5 µm inner diameter
- > Screw-in thread for quick assembly
- > Sterile
- > 100 % individual testing of every Femtotip using a flow parameter
- > Safe transport packaging

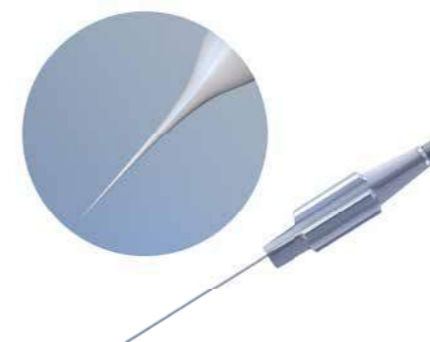

### Applications Femtotip II

- > Injection into adherent cells
- > Injection into suspension cells, smaller organisms or embryos in the early stages of development

### Femtotip II

- > Defined opening with 0.5 µm inner diameter
- > Screw-in thread for quick assembly
- > Sterile
- > 100 % individual testing of every Femtotip using a flow parameter
- > Safe transport packaging



### Applications Eppendorf Microloader™

- > Filling of microcapillaries for microinjection
- > Recovery of excess solution from the capillary
- > Pipetting smallest volumes where additional reach is needed

### Eppendorf Microloader™

- > Extremely long, fine and flexible tip for filling of microcapillaries for microinjection and where additional reach is needed
- > Microloader tips and rack autoclavable
- > Highest precision and accuracy when used with Eppendorf pipettes for 0.5 to 10 µL (gray control button)

For more information go to [www.eppendorf.com](http://www.eppendorf.com)

# Eppendorf Microcapillaries for Research

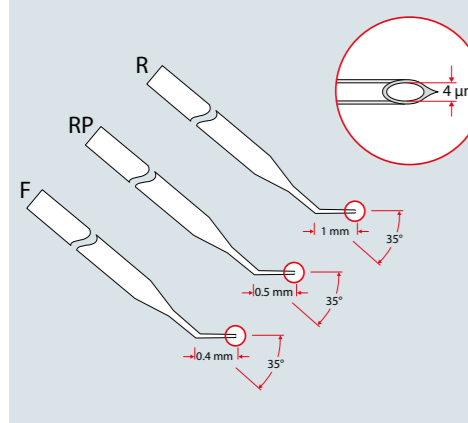

**Applications TransferTip® ICSI**

- > Transfer of sperm to oocytes

**TransferTip® ICSI**

- > 4 µm inner diameter
- > 35° tip angle
- > Heat-formed spike eases penetration
- > Sterilized via validated gamma irradiation
- > Non-cytotoxic (as proven by the mouse embryo development test)
- > Capillary safe for optimum protection
- > Three variants (F, RP, R) with different tip end characteristics

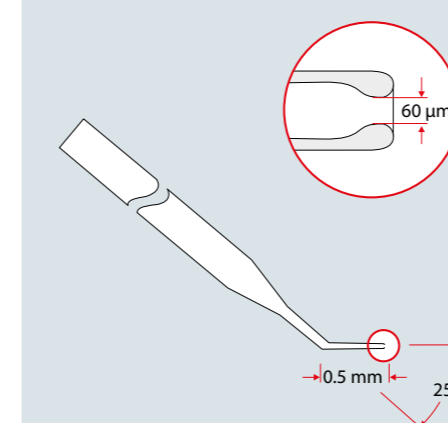

**Applications VacuTip II**

- > Capillary for holding oocytes, blastocysts, etc.

**VacuTip II**

- > 60 µm inner diameter
- > 25° tip angle
- > Flange length 0.5 mm
- > Sterilized via validated gamma irradiation
- > Non-cytotoxic (as proven by the mouse embryo development test)
- > Capillary safe for optimum protection

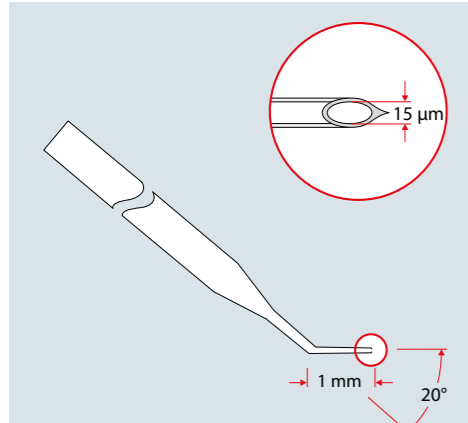

**Applications TransferTip® (ES)**

- > Transfer of ES cells into mouse blastula or morula

**TransferTip® (ES)**

- > 15 µm inner diameter
- > 20° tip angle
- > Rigid flange, 1 mm length
- > Heat-formed spike eases penetration
- > Sterilized via validated gamma irradiation
- > Capillary safe for optimum protection

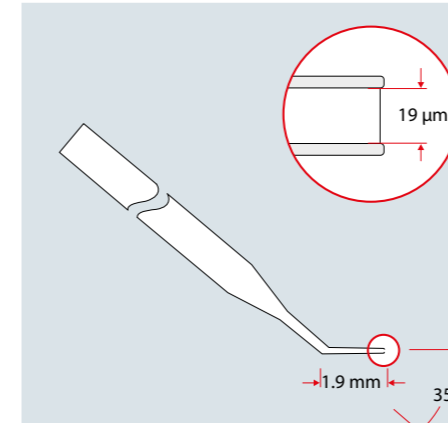

**Applications Biopsy Tip I**

- > Laser-assisted biopsy of cells and organelles

**Biopsy Tip I**

- > 19 µm inner diameter
- > 35° tip angle
- > Rigid flange, 1.9 mm length
- > Rounded tip end
- > Sterilized via validated gamma radiation
- > Non-cytotoxic (as proven by the mouse development test)
- > Capillary safe for optimum protection

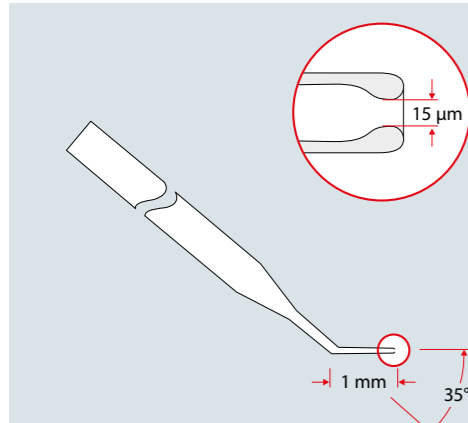

**Applications VacuTip I**

- > Capillary for holding oocytes, blastocysts, etc.

**VacuTip I**

- > 15 µm inner diameter
- > 35° tip angle
- > Flange length 1 mm
- > Sterilized via validated gamma irradiation
- > Non-cytotoxic (as proven by the mouse embryo development test)
- > Capillary safe for optimum protection

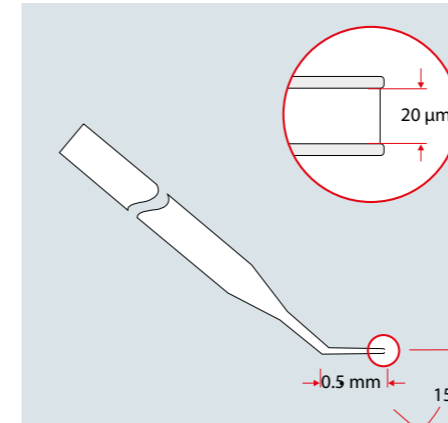

**Applications Biopsy Tip II**

- > Laser-assisted biopsy of cells and organelles

**Biopsy Tip II**

- > 20 µm inner diameter
- > 15° tip angle
- > Rigid 0.5 mm flange
- > Rounded tip end
- > Sterilized via validated gamma irradiation
- > Non-cytotoxic (as proven by the mouse development test)
- > Capillary safe for optimum protection

For more information go to [www.eppendorf.com](http://www.eppendorf.com)

# Eppendorf Microcapillaries for Research

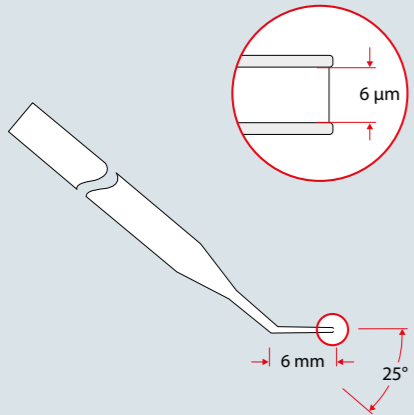

**Applications Piezo Drill Tip Mouse ICSI**  
 > Transfer of mouse spermatocytes into the cytoplasm of unfertilized mouse oocytes

**Piezo Drill Tip Mouse ICSI**

- > 6 µm inner diameter
- > 25° tip angle
- > Rigid flange, 6 mm length
- > Jagged, non-polished
- > Sterilized via validated gamma irradiation
- > Capillary safe for optimum protection

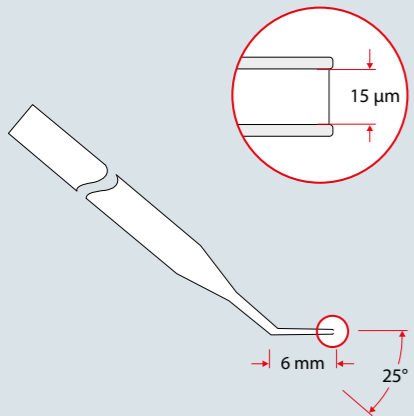

**Applications Piezo Drill Tip ES**  
 > Piezo-assisted transfer of embryonic stem cells into blastocysts

**Piezo Drill Tip ES**

- > 15 µm inner diameter
- > 25° tip angle
- > Rigid flange, 6 mm length
- > Jagged, non-polished
- > Sterilized via validated gamma irradiation
- > Capillary safe for optimum protection

## Ordering information

Description	Order no.
<b>Microloader™</b> , tip for filling Femtotips and other glass microcapillaries (for research use only), 0.5 – 20 µL, 100 mm, light gray, 192 pcs. (2 racks × 96 pcs.)	5242 956.003
<b>Femtotips®</b> , injection capillary (for research use only), sterile, set of 20	5242 952.008
<b>Femtotip II</b> , injection capillary (for research use only), sterile, set of 20	5242 957.000
<b>VacuTip I</b> , holding capillary (for research use only), 35° tip angle, 15 µm inner diameter, 1 mm flange, sterile, set of 25	5195 000.036
<b>VacuTip II</b> , holding capillary (for research use only), 25° tip angle, 60 µm inner diameter, 0.5 mm flange, sterile, set of 25	5195 000.044
<b>TransferTip® RP (ICSI)</b> , for sperm injection using the ICSI technique (for research use only), 35° tip angle, 4 µm inner diameter, 0.5 mm flange, sterile, set of 25	5195 000.010
<b>TransferTip® F (ICSI)</b> , for sperm injection using the ICSI technique (for research use only), 35° tip angle, 4 µm inner diameter, 0.4 mm flange, sterile, set of 25	5195 000.001
<b>TransferTip® R (ICSI)</b> , for sperm injection using the ICSI technique (for research use only), 35° tip angle, 4 µm inner diameter, 1 mm flange, sterile, set of 25	5195 000.028
<b>Biopsy Tip I</b> , capillary for laser-assisted biopsy of cells and organelles (for research use only), 35° tip angle, 19 µm inner diameter, 1.9 mm flange, sterile, set of 25	5195 000.052
<b>Biopsy Tip II</b> , capillary for laser-assisted biopsy of cells and organelles (for research use only), 15° tip angle, 20 µm inner diameter, 0.5 mm flange, sterile, set of 25	5195 000.060
<b>TransferTip® (ES)</b> , for ES cell transfer (for research use only), 20° tip angle, 15 µm inner diameter, 1 mm flange, sterile, set of 25	5195 000.079
<b>Piezo Drill Tip Mouse ICSI</b> , for piezo-assisted mouse ICSI (for research use only), 25° tip angle, 6 µm inner diameter, 6 mm flange, sterile, set of 25	5195 000.087
<b>Piezo Drill Tip ES</b> , for piezo-assisted mouse ES cell transfer (for research use only), 25° tip angle, 15 µm inner diameter, 6 mm flange, sterile, set of 25	5195 000.095

## Workstations for Microinjection and Micromanipulation



### Workstation for cell transfer and injection and related techniques

Recommended setup:  
 2 × TransferMan® 4r  
 1 × Microscope adapter  
 (to be specified at time of order)  
 1 × CellTram® 4r Air  
 1 × CellTram® 4r Oil  
 1 × set of 25 TransferTip®  
 microcapillaries (to be specified at  
 time of order)  
 1 × set of antivibration pads (number  
 and format depending on setup)

### Optional for piezo-assisted micromanipulation:

1 × Eppendorf PiezoXpert®  
 1 × set of 25 Piezo Drill Tips (to be  
 specified at time of order)



### Workstation for pronuclear and cytoplasmic injection of nucleic acid solutions

Recommended setup:  
 2 × TransferMan® 4r  
 1 × Microscope adapter  
 (to be specified at time of order)  
 1 × CellTram® 4r Air  
 1 × FemtoJet® 4i or FemtoJet® 4x  
 1 × set of 20 Femtotip II  
 2 × racks of 96 Microloader  
 1 × set of Antivibration Pads  
 (number and format depending on  
 setup)

### Optional for piezo-assisted micromanipulation:

1 × Eppendorf PiezoXpert®  
 1 × Y cable PX



### Workstation for adherent cell injection or injection into *Drosophila*, *C.elegans*, plant cells etc.

Recommended setup:  
 1 × InjectMan® 4  
 1 × Microscope adapter (to be specified  
 at time of order)  
 1 × FemtoJet® 4i or FemtoJet® 4x  
 1 × set of 20 Femtotips® (to be specified  
 at time of order)  
 2 × racks of 96 Microloader  
 1 × Eppendorf Cell Imaging Dishes  
 1 × set of antivibration pads (number  
 and format depending on setup)



### Workstation for injection into fish embryos

Recommended setup:  
 1 × InjectMan 4  
 1 × Universal stand  
 1 × FemtoJet® 4x  
 1 × set of 20 Femtotips® (to be specified  
 at time of order)  
 2 × racks of 96 Microloader

### Optional for piezo-assisted injection:

Recommended setup:  
 1 × Eppendorf PiezoXpert®  
 1 × Y cable PX



# Eppendorf Cell Culture Consumables

## Description

Experience a new dimension in cell culture with Eppendorf Cell Culture Consumables. These products meet your needs for excellent cell performance and reliability as well as for advanced protection against contamination.

Innovative technologies for surface activation deliver a tissue-culture-treated (TC treated) surface with outstanding homogeneity.

The planarity and transparency of all surfaces contribute to an optical performance that not only facilitates your routine analysis, but also saves time during automated read-out.

In all formats, we focused on advanced handling, secure stacking, and easy identification, readability and tracking.

The new packaging concept provides complete protection during transportation, tool-free opening, easy resealing for safe and clean storage, and fast identification of the desired product. The boxes and bags are very compact for space saving storage. Learn more about the truly comprehensive solutions for cell culture on the following pages.



[www.eppendorf.com/ccc-brochure](http://www.eppendorf.com/ccc-brochure)

## Applications

> Expansion and culture of adherent and suspension cells on TC treated or on non-treated polystyrene

> Performance of cell-based assays and microscopic analysis

## All Cell Culture Consumables

<b>Surface</b>	Tissue culture treated or non-treated
<b>Operating temperature</b>	-86 °C to 60 °C
<b>Storage before use</b>	Store dry and at RT. Protect from sunlight and UV rays
<b>Purities</b>	All products are sterile. Sterility is assured by irradiation according to DIN EN ISO 11137-2015 with sterility assurance level (SAL) of 10 <sup>-6</sup> . Sterility is tested according to USP, Ph. Eur. 2.6.12. All products are free of detectable pyrogens, RNase, DNase and DNA. All products are non-cytotoxic.
<b>Certificates</b>	Leachables, heavy metals, production conditions, cytotoxicity. The certificates can be downloaded at <a href="http://www.eppendorf.com">www.eppendorf.com</a>
<b>Lot-specific certificates</b>	Sterility Absence of: Pyrogens, RNase, DNase, DNA. TC treated surface: Testing for cell attachment and cell growth with an anchorage-dependent cell line Lot-specific certificates can be downloaded at <a href="http://www.eppendorf.com">www.eppendorf.com</a>

# Eppendorf Cell Culture Plates

## Description

Eppendorf Cell Culture Plates are tailored for the expansion of smaller cell numbers as well as for cell-based assays. Qualification of cell morphology and cell performance can be especially critical in those steps. We optimized the optical performance by enhancement of the planarity, material clarity, and reduction of the liquid meniscus to facilitate both manual and automated read-out. Contrast rich alphanumeric OptiTrack® labeling allows for easy orientation and fast identification of individual wells. The new chimney-well design avoids inhomogeneous growth of cells in the outer ring of wells which reduces costs and increases efficiency. If cells need to spend more time outside of the incubator, filling the inter-well spaces of the plate will keep the temperature stable and prevent unwanted temperature shifts. The lid and plate bottom can easily be differentiated providing extra safety in transportation and stacking.

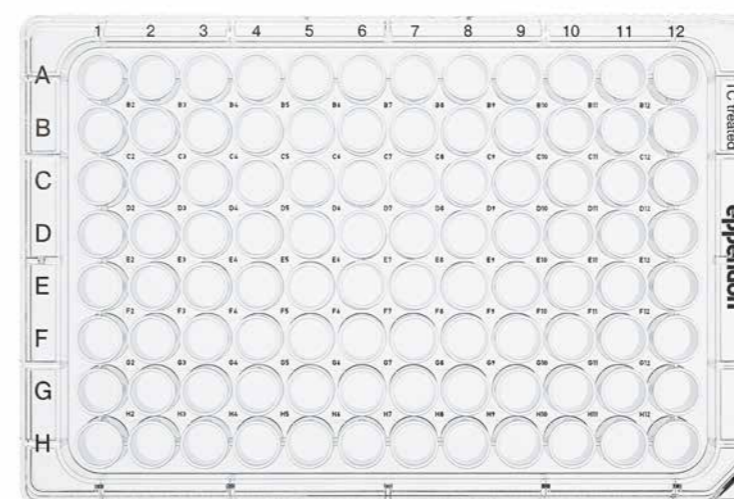

[www.eppendorf.com/ccplates-video](http://www.eppendorf.com/ccplates-video)

[www.eppendorf.com/ccplates-video2](http://www.eppendorf.com/ccplates-video2)

## Product features

- > Easy and fast well identification by contrast rich individual well ID and OptiTrack alphanumeric labeling
- > Moat surrounding the outer wells to prevent the "edge effect" when filled with liquid
- > Chimney-well design enables filling of the inter-well spaces of the plate to level out well-to-well temperature shifts outside the incubator
- > Robust stacking performance by pronounced rims on plate lid and excellent fitting of lid and base when used in stacks
- > Lid taps under the plate for minimized surface contact and therefore reduced risk of contamination
- > Easy differentiation of lid and plate bottom due to a pronounced corrugation and wider sized base
- > Pronounced ventilation gaps for optimized gas and temperature transfer when incubating in stacks
- > Optimized microscopical performance due to enhanced planarity, reduction of meniscus and clarity of the material

Plates	6-Well	12-Well	24-Well	48-Well	96-Well
<b>Theoretical total volume</b>	16.0 mL	6.8 mL	3.6 mL	1.5 mL	0.4 mL
<b>Work volume</b>	3 – 5 mL	1 – 2 mL	0.5 – 1 mL	0.3 – 0.5 mL	0.1 – 0.2 mL
<b>Growth area/well<sup>1)</sup></b>	940.3 mm <sup>2</sup>	391.1 mm <sup>2</sup>	208.9 mm <sup>2</sup>	85.6 mm <sup>2</sup>	37.0 mm <sup>2</sup>
<b>Well diameter</b>	34.6 mm	22.4 mm	16.2 mm	10.4 mm	6.8 mm
<b>L x W x H</b>	127.8 x 85.5 x 20.0 mm	127.8 x 85.5 x 20.0 mm	127.8 x 85.5 x 20.0 mm	127.8 x 85.5 x 20.0 mm	127.8 x 85.5 x 14.4 mm
<b>Height with lid</b>	23.2 mm	23.2 mm	23.2 mm	23.2 mm	17.6 mm
<b>Dimensions</b>	Conforms to ANSI/SBS I	Conforms to ANSI/SBS I	Conforms to ANSI/SBS I	Conforms to ANSI/SBS I	Conforms to ANSI/SBS I to V
<b>Centrifugation</b>	Can be centrifuged up to 2,500 x g. When stacked (up to 5 for 96-Well plates and up to 4 for all other formats) can be centrifuged up to 300 x g.				

<sup>1)</sup> For the initial seeding of cells, take into account the growth area in order to support optimal cell growth.

# Eppendorf Cell Culture Plates

## Minimizing the edge effect in 96-well plates

Evaporation of cell culture medium plays a critical role in multi-well based cellular assays because it can deteriorate assay performance. As evaporation mainly affects the peripheral wells of a plate this phenomenon is called the edge effect. With the Eppendorf 96-Well Cell Culture Plate evaporation from the wells can be reduced to a minimum. The plate offers two options for insulating the wells. A moat surrounding the edge wells and the complete chimney design of the inner wells allow filling of the complete inter-well space with liquid. Together this results in a more homogeneous distribution of temperature and humidity throughout the plate and reduces the edge effect.



The filling of the surrounding moat prevents edge effect and yields up to 38 % more usable wells



Filling the complete inter-well space enables for additional insulation of all 96 wells. This not only prevents the edge effect, it also prevents well-to-well temperature shifts outside the incubator

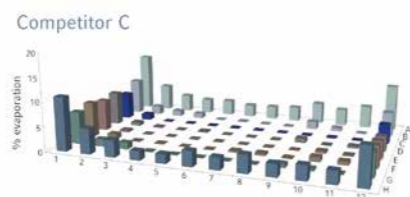
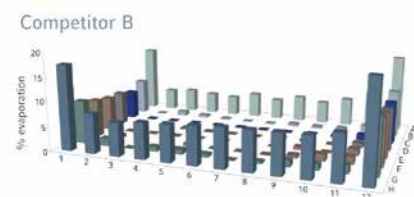
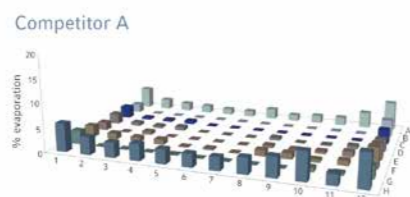
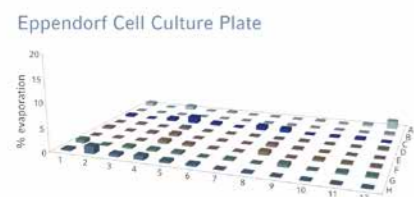

[www.eppendorf.com/ccplates-app326](http://www.eppendorf.com/ccplates-app326)



[www.eppendorf.com/ccplates-app384](http://www.eppendorf.com/ccplates-app384)

Figure 2: Comparison of evaporation in different 96-well plates. Liquid loss inside each well was determined after 5 days of incubation under standard cell culture conditions.

## Comparison of evaporation in different 96-well plates

A comparison of different 96-well cell culture plates shows that filling the outer moat of the Eppendorf Cell Culture Plate leads to a superior well-to-well consistency in cell growth in the Eppendorf Cell Culture Plate. By this, the phenomenon of the edge effect can be minimized leading to reproducible performance in cellbased assays. For this test the outer moat of the Eppendorf plate was filled with 1 x 5 mL of phosphate buffered saline (PBS). The inner inter-well space was filled with 1 x 8 mL of phosphate buffered saline (PBS). For more information see Application Notes 326 and 384.

# Eppendorf Cell Culture Dishes

## Description

Whenever you need direct access to your cells, dishes are the format of choice. Eppendorf cell culture dishes were designed with a focus on improved handling and stacking performance to ensure a new level of safe and carefree usage. It all starts with the packaging: the innovative design can be easily opened without tools and resealed without tape. The bags are shrinkable for space-saving, safe, and contamination-free storage of unused dishes. With the Eppendorf dishes, a corrugated handling ring provides unsurpassed safety in handling during transportation and expansion of cells. A SplashProtect™ ring inside the dish lid prevents spillage and traps fluid if condensation occurs. Combined with the outstanding, sturdy stacking, our cell culture dishes are unparalleled in their ease of transport and handling, safety, and convenience.



## Product features

- > Unsurpassed safety in handling during transportation and while working due to corrugated handling ring
- > SplashProtect™ ring inside of the dish lid traps liquid and prevents spills during transportation or incubation
- > Pronounced rim on dish lid and exact fitting of lid and bottom ensure sturdy, secure stacking
- > Easy differentiation of lid and dish bottom prevents unintended removal of the lid
- > Packaging combines tool-free opening, resealable top and side for tape-free closing, and an easy solution to shrink the package for space-conscious storage

Dishes	35 mm	60 mm	100 mm
Theoretical total volume	8.1 mL	26.6 mL	99.2 mL
Work volume	2.0 – 3.0 mL	3.0 – 5.0 mL	8.0 – 10.0 mL
Growth area	9.5 cm <sup>2</sup>	21.9 cm <sup>2</sup>	56.8 cm <sup>2</sup>
Diameter x height	36.7 x 10.8 mm	59.7 x 14.0 mm	93.8 x 19.4 mm
Height with lid	12.5 mm	15.7 mm	21.3 mm
Centrifugation	Cannot be centrifuged.		



[www.eppendorf.com/ccdishes-video](http://www.eppendorf.com/ccdishes-video)



[www.eppendorf.com/ccdishes-video2](http://www.eppendorf.com/ccdishes-video2)

# Eppendorf Cell Culture Flasks

## Description

Flasks are the preferred vessel for long term cultivation or large-scale expansion of cells, providing the best protection against contamination. Unsurpassed protection of your cells from contaminants was one of the key requirements in developing the Eppendorf Cell Culture Flasks. A new, high efficiency air filter technology combines excellent protection with reliable gas exchange. In-line pressure testing for each flask guarantees leakage-free flasks for maximum workflow safety. The unique ConvexAccess™ shape of the neck facilitates the access to the growth area and makes cell seeding and media exchange much more convenient, safe, and reliable.



## Product features

- > ConvexAccess™ geometry for facilitated access to growth area and easier and safe cell treatment
- > Optimized gas exchange and protection against contamination through high efficiency air filter technology
- > Defined arrested position on plug-seal caps to prevent undesired closing
- > Anti-rolling cap with corrugation facilitates cultivation steps when the cap needs to be set aside
- > 100 % in-line control for leakage-free flasks and maximum safety
- > Direct surface identification on flask and cap

Flasks	T-25	T-75	T-175
Theoretical total volume	83.6 mL	279.8 mL	662.1 mL
Work volume	3.0 – 7.0 mL	8.0 – 20.0 mL	20.0 – 30.0 mL
Growth area	26.9 cm <sup>2</sup>	77.9 cm <sup>2</sup>	179.5 cm <sup>2</sup>
L x W x H	99.0 x 56.0 x 37.0 mm	163.0 x 82.0 x 46.6 mm	230.0 x 122.0 x 48.0 mm
Centrifugation	Can be centrifuged with the suitable adapters; refer to the manufacturer's instruction.		



[www.eppendorf.com/ccflasks-video](http://www.eppendorf.com/ccflasks-video)

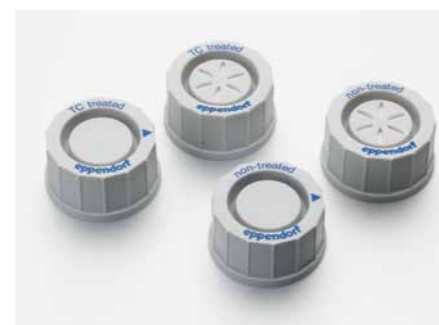

## Reinvented Filter Technology for More Safety and Reliance

Flasks have always been the preferred vessel for long term cultivation or large-scale expansion of cells. Membrane filters, known to guarantee protection against contamination and optimal gas exchange were the state of the art up to now. Only Eppendorf challenged the status quo and reinvented the filter technology for Cell Culture Flasks for a higher safety standard.

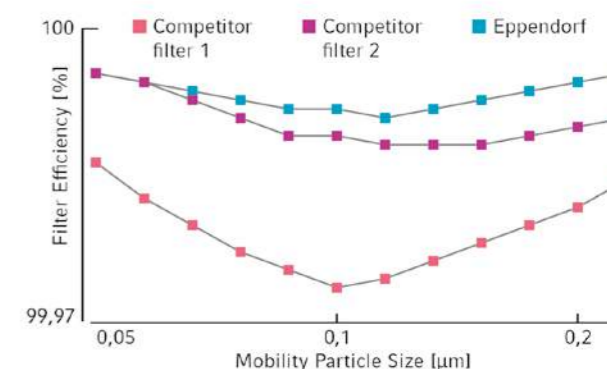
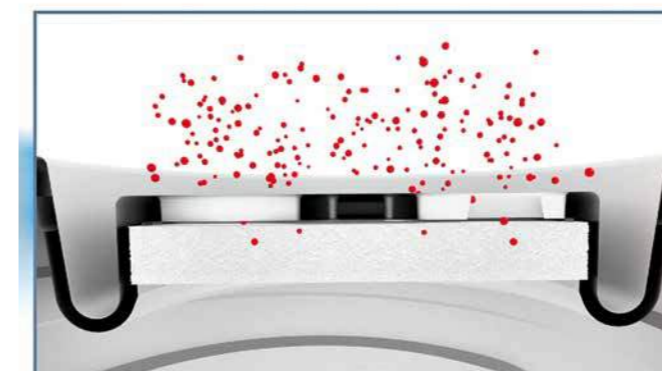

## Unmatched volume filter technology

Instead of utilizing thin membrane filters Eppendorf filter caps are equipped with a reinvented high efficiency volume filter providing reliable gas exchange and better protection against airborne particles

## Remarkable increase in filter efficiency

The hydrophobic volume filter pad is more efficient than standard filter membranes in protection against contamination. For more information have a look at our Whitepaper No. 024

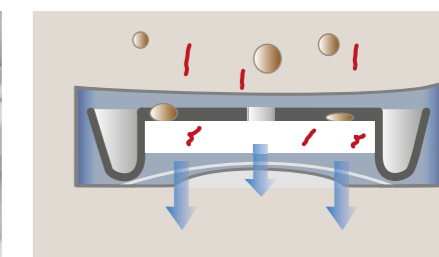
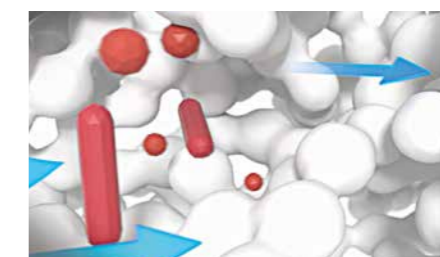
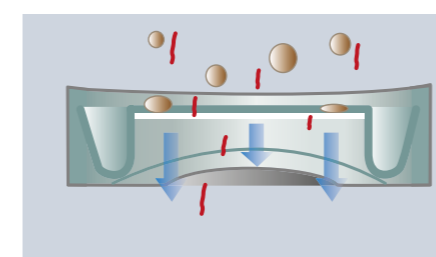

## Standard membrane filter

Membrane filter with defined and constant pore size. Particles smaller than this size can pass through

## Unsurpassed Eppendorf volume filter technology

The labyrinthine arrangement of filter pores in various sizes combined with greater filter thickness enable higher efficiency in holding back contaminants, such as bacteria, virus or mycoplasma, and therefore, in preventing contamination



[www.eppendorf.com/ccflasks-video2](http://www.eppendorf.com/ccflasks-video2)

## Eppendorf Cell Culture Consumables

Ordering information	
Description	Order no.
<b>Eppendorf Cell Culture Plates, 6-Well</b> , Sterile, pyrogen-, DNase-, RNase-, human and bacterial DNA-free. Non-cytotoxic	
TC treated, 5 mL, 60 plates, individually wrapped	0030 720.113
non-treated, 5 mL, 60 plates, individually wrapped	0030 720.016
TC treated, 5 mL, 100 plates (10 bags × 10 plates)	0030 720.130
<b>Eppendorf Cell Culture Plates, 12-Well</b> , Sterile, pyrogen-, DNase-, RNase-, human and bacterial DNA-free. Non-cytotoxic	
TC treated, 2 mL, 60 plates, individually wrapped	0030 721.110
non-treated, 2 mL, 60 plates, individually wrapped	0030 721.012
<b>Eppendorf Cell Culture Plates, 24-Well</b> , Sterile, pyrogen-, DNase-, RNase-, human and bacterial DNA-free. Non-cytotoxic	
TC treated, 1 mL, 60 plates, individually wrapped	0030 722.116
non-treated, 1 mL, 60 plates, individually wrapped	0030 722.019
<b>Eppendorf Cell Culture Plates, 48-Well</b> , Sterile, pyrogen-, DNase-, RNase-, human and bacterial DNA-free. Non-cytotoxic	
TC treated, 0.5 mL, 60 plates, individually wrapped	0030 723.112
non-treated, 0.5 mL, 60 plates, individually wrapped	0030 723.015
<b>Eppendorf Cell Culture Plates, 96-Well</b> , Sterile, pyrogen-, DNase-, RNase-, human and bacterial DNA-free. Non-cytotoxic	
TC treated, 0.2 mL, 80 plates, individually wrapped	0030 730.119
non-treated, 0.2 mL, 80 plates, individually wrapped	0030 730.011
TC treated, 0.2 mL, 100 plates (10 bags × 10 plates)	0030 730.135

Ordering information	
Description	Order no.
<b>Eppendorf Cell Culture Dishes, 35 mm</b> , Sterile, pyrogen-, DNase-, RNase-, human and bacterial DNA-free. Non-cytotoxic	
TC treated, 3.0 mL, 300 dishes (30 bags × 10 dishes)	0030 700.112
non-treated, 3.0 mL, 300 dishes (30 bags × 10 dishes)	0030 700.015
<b>Eppendorf Cell Culture Dishes, 60 mm</b> , Sterile, pyrogen-, DNase-, RNase-, human and bacterial DNA-free. Non-cytotoxic	
TC treated, 5.0 mL, 300 dishes (30 bags × 10 dishes)	0030 701.119
non-treated, 5.0 mL, 300 dishes (30 bags × 10 dishes)	0030 701.011
<b>Eppendorf Cell Culture Dishes, 100 mm</b> , Sterile, pyrogen-, DNase-, RNase-, human and bacterial DNA-free. Non-cytotoxic	
TC treated, 10.0 mL, 300 dishes (30 bags × 10 dishes)	0030 702.115
non-treated, 10.0 mL, 300 dishes (30 bags × 10 dishes)	0030 702.018

Ordering information	
Description	Order no.
<b>Eppendorf Cell Culture Flasks T-25</b> , Sterile, pyrogen-, DNase-, RNase-, human and bacterial DNA-free. Non-cytotoxic	
TC treated, with filter cap, 7.0 mL, 192 flasks (24 bags × 8 flasks)	0030 710.126
TC treated, with plug-seal cap, 7.0 mL, 192 flasks (24 bags × 8 flasks)	0030 710.118
non-treated, with filter cap, 7.0 mL, 192 flasks (24 bags × 8 flasks)	0030 710.029
non-treated, with plug-seal cap, 7.0 mL, 192 flasks (24 bags × 8 flasks)	0030 710.010
<b>Eppendorf Cell Culture Flasks T-75</b> , Sterile, pyrogen-, DNase-, RNase-, human and bacterial DNA-free. Non-cytotoxic	
TC treated, with filter cap, 20.0 mL, 80 flasks (16 bags × 5 flasks)	0030 711.122
TC treated, 20.0 mL, 80 flasks (16 bags × 5 flasks)	0030 711.114
non-treated, with filter cap, 20.0 mL, 80 flasks (16 bags × 5 flasks)	0030 711.025
non-treated, with plug-seal cap, 20.0 mL, 80 flasks (16 bags × 5 flasks)	0030 711.017
<b>Eppendorf Cell Culture Flasks T-175</b> , Sterile, pyrogen-, DNase-, RNase-, human and bacterial DNA-free. Non-cytotoxic	
TC treated, with filter cap, 30.0 mL, 48 flasks (12 bags × 4 flasks)	0030 712.129
TC treated, with plug-seal cap, 30.0 mL, 48 flasks (12 bags × 4 flasks)	0030 712.110
non-treated, with filter cap, 30.0 mL, 48 flasks (12 bags × 4 flasks)	0030 712.021
non-treated, with plug-seal cap, 30.0 mL, 48 flasks (12 bags × 4 flasks)	0030 712.013

## Eppendorf Cell Imaging Consumables

### Description

Eppendorf Cell Imaging Consumables allow sophisticated imaging and microscopy applications on an expert level. The products combine premium performance with innovative solutions for demanding optical analysis and fluorescent stainings. Whether you perform inverse microscopy, life cell imaging or fluorescence-based analysis:

Find tailored solutions for single and parallel analysis as well as High Content Analysis (HCA) with Eppendorf Cell Imaging Consumables.



### Eppendorf Cell Imaging Plates

Eppendorf Cell Imaging Plates with film bottom have excellent light transmission rates even for UV-A and UV-B light. The autofluorescence of the material is lower than a conventional polystyrene bottom with a significant reduction in background signaling. Furthermore, the film bottom enables high gas transfer: oxygen supply and equilibration with the atmosphere are achieved directly through the plate bottom. The glass bottom plates offer excellent planarity for sophisticated microscopic analysis.

### Eppendorf Cell Imaging Slides

Eppendorf Cell Imaging Slides and Coverglasses offer a high chemical resistance of materials for reliable and reproducible results in fixation protocols. Tool-free and easy removal of chambers from Cell Imaging Slides and Coverglasses makes working easy, convenient and reliable. Products are available with one to eight chambers to suit a variety of applications.

### Eppendorf Cell Imaging Dishes

Eppendorf Cell Imaging Dishes ensure excellent results in high resolution microscopy of living and fixed cells. The bottom of the 35 mm dishes is made from cover glass. The central 18 mm cavity is lower than the level of the surrounding polystyrene dish, which enables the concentration of the cells during seeding on the glass surface and helps to reduce costs of antibodies and dyes. Plate handling and reference are easy, safe, and convenient due to a polygonal gripping zone and directional orientation marking.

# Eppendorf Cell Imaging Consumables

## Product features

- > Outstanding performance of glass and film surfaces for adherent cells due to innovative tissue culture treatment
- > Low intrinsic fluorescence and high light transmission for enhanced signal-to-noise ratio
- > Easy access to the complete imaging area with immersion lenses for alleviated handling and advanced compatibility with microscopes
- > Ergonomic and robust design
- > Precise planarity supports high resolution microscopes and autofocus systems



## Special Features Cell Imaging Plates

- > All plate types have a low skirt design perfectly suited to access all wells with immersion objectives
- > An excellent signal-to-noise ratio can be expected regardless of the plate bottom type
- > Excellent planarity of all plates ensures unsurpassed manual handling and reliable results in automated devices
- > Individually wrapped for reliable purity
- > The ultrathin film bottom allows for high gas permeability and UV-light transparency, ideal for phototoxicity and hypoxic studies

## Special Features Cell Imaging Slides and Coverglasses

- > Choose between a microscopic slide with 1 mm thickness or a 170 µm coverglass, both providing excellent signal-to-noise ratios in fluorescent staining protocols
- > Chambers and lids show high chemical resistance, so fixation even with acetone is possible without problems
- > Benefit from easy and tool-free removal of the chambers with minimized glue residues

## Special Features Cell Imaging Dishes

- > An 18 mm central cavity for defined growth and staining of cells for reduced costs of antibodies and dyes
- > Polygonal gripping zone for improved handling
- > Macroscopic orientation marks facilitate easy orientation
- > Low rim side walls allow easy access for microinjection/micromanipulation
- > Available thickness: 145 µm and 170 µm

## Ordering information

Description	Order no.
<b>Eppendorf Cell Imaging Plates</b> , with lid, black with clear F-bottom. Sterile, pyrogen-, DNase-, RNase-, human and bacterial DNA-free. Non-cytotoxic	
TC Treated, 24-Well Cell Imaging Plate with 170 µm coverglass bottom, individually wrapped, 20 pcs.	0030 741.021
TC Treated, 96-Well Cell Imaging Plate with 170 µm coverglass bottom, individually wrapped, 20 pcs.	0030 741.030
TC Treated, 24-Well Cell Imaging Plate with 25 µm film bottom, individually wrapped, 20 pcs.	0030 741.005
TC Treated, 96-Well Cell Imaging Plate with 25 µm film bottom, individually wrapped, 20 pcs.	0030 741.013

## Ordering information

Description	Order no.
<b>Eppendorf Cell Imaging Dishes</b> , with coverglass bottom. Sterile, pyrogen-, DNase-, RNase-, human and bacterial DNA-free. Non-cytotoxic	
TC Treated, 35 x 10 mm Cell Imaging Dish 145 µm (1), 2 dishes per bag, 30 pcs.	0030 740.009
TC Treated, 35 x 10 mm Cell Imaging Dish 170 µm (1.5), 2 dishes per bag, 30 pcs.	0030 740.017

## Ordering information

Description	Order no.
<b>Eppendorf Cell Imaging Slides</b> , Sterile, pyrogen-, DNase-, RNase-, human and bacterial DNA-free. Non-cytotoxic	
TC Treated, Cell Imaging Slide with 1 chamber, individually wrapped, 16 pcs.	0030 742.044
TC Treated, Cell Imaging Slide with 2 chambers, individually wrapped, 16 pcs.	0030 742.052
TC Treated, Cell Imaging Slide with 4 chambers, individually wrapped, 16 pcs.	0030 742.060
TC Treated, Cell Imaging Slide with 8 chambers, individually wrapped, 16 pcs.	0030 742.079
<b>Eppendorf Cell Imaging Coverglasses</b> , Sterile, pyrogen-, DNase-, RNase-, human and bacterial DNA-free. Non-cytotoxic	
TC Treated, Cell Imaging Coverglass with 1 chamber, individually wrapped, 16 pcs.	0030 742.001
TC Treated, Cell Imaging Coverglass with 2 chambers, individually wrapped, 16 pcs.	0030 742.010
TC Treated, Cell Imaging Coverglass with 4 chambers, individually wrapped, 16 pcs.	0030 742.028
TC Treated, Cell Imaging Coverglass with 8 chambers, individually wrapped, 16 pcs.	0030 742.036



[www.eppendorf.com/cic-video](http://www.eppendorf.com/cic-video)



[www.eppendorf.com/cic-brochure](http://www.eppendorf.com/cic-brochure)

# Cell Handling



Model	Galaxy® 48 R	Galaxy® 170 R
Page(s)	300	302
Capacity	48 L	170 L
Dimensions (W x D x H)	48.3 x 47.5 x 64.5 cm	70.8 x 71.1 x 84.5 cm
Dimensions internal (W x D x H)	40.1 x 30.5 x 40.1 cm	53.3 x 44.4 x 69.1 cm
Weight w/o accessories	31.8 kg	89.9 kg
Communication port	RS-232	RS-232
Display	LCD	LCD
Benchtop (B), Under Bench (U), Floor (F) or Stackable (S)	B, U, F, S (x2)	B, U, F, S (x2)
Temperature range	Ambient +4 °C to 50 °C	Ambient +4 °C to 50 °C
Temperature control	±0.1 °C	±0.1 °C
Temperature stability at 37 °C	±0.1 °C	±0.1 °C
Temperature uniformity	±0.3 °C	±0.3 °C
CO <sub>2</sub> range	0.2 – 20 %	0.2 – 20 %
CO <sub>2</sub> control	±0.1 %	±0.1 %
CO <sub>2</sub> stability at 5 % CO <sub>2</sub>	±0.2 %	±0.2 %
CO <sub>2</sub> uniformity	±0.1 %	±0.1 %
0.1 – 19 % O <sub>2</sub> control	optional	optional
1 – 19 % O <sub>2</sub> control	optional	optional
Access port, 25 mm	standard	standard
BMS relay	standard	standard
Copper chamber		optional
High temperature disinfection (4 hours at 120 °C)	optional	optional
Humidity alert and monitoring package	optional	optional
No. of shelves	3 (6 optional)	4 (8 optional)
Number of shelving racks	6	8
On-board data logging	standard	standard
Perforated shelves	standard	standard
Sealed inner glass doors		standard
2 split inner doors	optional	
4 split inner doors		optional
8 split inner doors		optional
Shaking		
Platform size		
Speed range		

i For more information go to [www.ependorf.com](http://www.ependorf.com)

Technical specifications subject to change.



Model	Galaxy® 170 S	New Brunswick™ S41i
Page(s)	304	306
Capacity	170 L	170 L
Dimensions (W x D x H)	70.8 x 71.1 x 84.5 cm	83.4 x 73 x 84.8 cm / 32.8 x 28.7 x 33.4 in
Dimensions internal (W x D x H)	53.3 x 44.4 x 69.1 cm	69.1 x 44.4 x 53.8 cm
Weight w/o accessories	89.9 kg	152 kg / 335 lb
Communication port	RS-232	Ethernet
Display	LED	Touchscreen
Benchtop (B), Under Bench (U), Floor (F) or Stackable (S)	B, U, F, S (x2)	U, F, S (x2)
Temperature range	Ambient +4 °C to 50 °C	Ambient +4 °C to 50 °C
Temperature control	±0.1 °C	±0.1 °C
Temperature stability at 37 °C	±0.1 °C	±0.1 °C
Temperature uniformity	±0.3 °C	±0.25 °C at 37 °C
CO <sub>2</sub> range	0.2 – 20 %	0.2 – 20 %
CO <sub>2</sub> control	±0.1 %	±0.1 %
CO <sub>2</sub> stability at 5 % CO <sub>2</sub>	±0.2 %	±0.2 %
CO <sub>2</sub> uniformity	±0.1 %	±0.1 %
0.1 – 19 % O <sub>2</sub> control		
1 – 19 % O <sub>2</sub> control		
Access port, 25 mm	standard	standard
BMS relay	standard	standard
Copper chamber		
High temperature disinfection (4 hours at 120 °C)	optional	standard
Humidity alert and monitoring package		
No. of shelves	4 (8 optional)	1 (2nd optional)
Number of shelving racks	4 (8 optional)	2
On-board data logging		standard
Perforated shelves		standard
Sealed inner glass doors		standard
2 split inner doors		
4 split inner doors		
8 split inner doors		
Shaking		standard
Platform size		36 x 61 cm (14 x 24 in)
Speed range		25 – 400 rpm

**epServices** for premium performance On page 380 and 384 you will find detailed information on services for these products!

Your local distributor: [www.ependorf.com/contact](http://www.ependorf.com/contact)  
 Eppendorf AG · Barkhausenweg 1 · 22339 Hamburg · Germany · [ependorf@ependorf.com](mailto:ependorf@ependorf.com) · [www.ependorf.com](http://www.ependorf.com)

# Galaxy® 48 R

## Description

The Galaxy 48 R CO<sub>2</sub> Incubator is a mid-sized, 48 liter incubator designed to optimize performance in applications that require a higher level of isolation and can be used in small labs. The 48 R series of incubators feature a large backlit display with on screen help menu, control and data logging of temperature, CO<sub>2</sub>, door openings, alarms, and optional O<sub>2</sub> gas and humidity monitoring.



## Product features

- > 48 Liter (1.7 ft<sup>3</sup>) provides mid-sized capacity within a small footprint
- > Options: High Temp. Disinfection (4 hour at 120 °C), O<sub>2</sub> control (e.g. for hypoxic studies), 2-split inner glass door
- > Fanless design offers more usable space
- > Six-sided direct heating system provides a uniform incubated environment
- > Deep-drawn, easy-to-clean stainless steel chamber without seams or welds
- > Low gas consumption
- > Integrated alarm relay

## Ordering information

Description	Order no.
<b>Galaxy® 48 R, 48 L, Stock, 230 V/50/60 Hz</b>	
Standard	CO48300001
1 – 19 % O <sub>2</sub> Control	CO48320001
High-Temp Disinfection	CO48310001
High-Temp Disinfection, 1 – 19 % O <sub>2</sub> Control	CO48330001
<b>Galaxy® 48 R, 48 L, Built to Order, 230 V/50/60 Hz</b>	
High-Temp Disinfection, 2-Split Inner Door	CO48312001
High-Temp Disinfection, 0.1 – 19 % O <sub>2</sub> Control	CO48310041
High-Temp Disinfection, 0.1 – 19 % O <sub>2</sub> Control, Humidity Package	CO48310061
High-Temp Disinfection, 0.1 – 19 % O <sub>2</sub> Control, 2-Split Inner Door	CO48312041
High-Temp Disinfection, 0.1 – 19 % O <sub>2</sub> Control, 2-Split Inner Door, Humidity Package	CO48312061
High-Temp Disinfection, 1 – 19 % O <sub>2</sub> Control, 2-Split Inner Door	CO48332001
High-Temp Disinfection, 1 – 19 % O <sub>2</sub> Control, 2-Split Inner Door, Humidity Package	CO48332011

✎ Ordering information for other voltage options begins on page 434



One piece seamless chamber minimizes contamination risk and simplifies cleaning



Integrated, heated, viewing window in outer door allows observation without disturbing cultures

For more information go to [www.eppendorf.com](http://www.eppendorf.com)

# Galaxy<sup>®</sup> 170 R

## Description

Galaxy 170 R CO<sub>2</sub> Incubators are high-capacity, 170 liter incubators that provide excellent quality, outstanding performance, and intuitive operation. These models can be conveniently placed on or under the bench or even double-stacked. Galaxy 170 R models provide a tremendous amount of usable space that can be optimized with options such as High Temperature Disinfection, O<sub>2</sub> control, and split inner doors. Galaxy 170 R incubators feature an integrated controller for simple on-screen and data logging.



## Product features

- > Standard features: Sealed inner glass door, reliable IR CO<sub>2</sub> sensor, RS-232 communication port, 25 mm access ports
- > Two O<sub>2</sub> control options (0.1 – 19 %, 1 – 19 %) for hypoxic studies, also available with split inner doors
- > Further Options: High Temperature Disinfection (4 hour at 120 °C), copper chamber and interior for optimized protection against contamination, humidity alert package
- > Fanless design offers more usable space and eliminates the fan, an often repeated source of contamination
- > Six-sided direct heating system provides a uniform incubated environment
- > Deep-drawn, stainless steel chamber eliminates seams or welds and allows easy cleaning
- > Low gas consumption
- > Integrated alarm relay

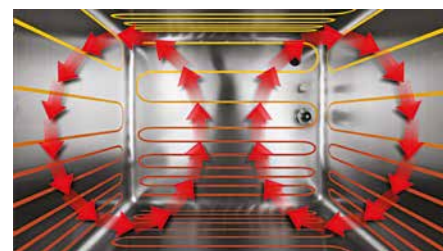

All Galaxy incubators have a six-sided direct heating with natural fanless convection circulation

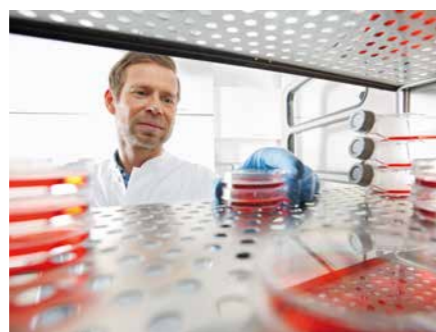

Perforated shelves come standard on all Galaxy CO<sub>2</sub> Incubators

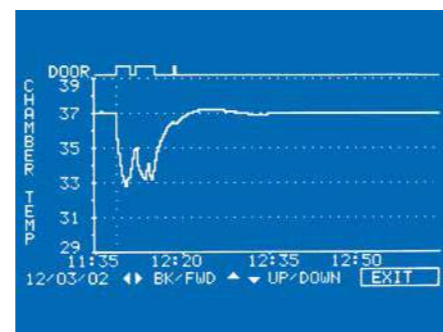

Galaxy R Series LCD interface, standard on Galaxy 170 R and Galaxy 48 R models

## Ordering information

Description	Order no.
<b>Galaxy<sup>®</sup> 170 R, 170 L, Stock, 230 V/50/60 Hz</b>	
Standard	C017301001
1 – 19 % O <sub>2</sub> Control	C017321001
High-Temp Disinfection	C017311001
High-Temp Disinfection, 4-Split Inner Door	C017314001
High-Temp Disinfection, 1 – 19 % O <sub>2</sub> Control	C017331001
High-Temp Disinfection, 1 – 19 % O <sub>2</sub> Control, 4-Split Inner Door	C017334001
<b>Galaxy<sup>®</sup> 170 R, 170 L, Built to Order, 230 V/50/60 Hz</b>	
4-Split Inner Door	C017304001
8-Split Inner Door	C017308001
1 – 19 % O <sub>2</sub> Control, 4-Split Inner Door	C017324001
1 – 19 % O <sub>2</sub> Control, 8-Split Inner Door	C017328001
High-Temp Disinfection, 0.1 – 19 % O <sub>2</sub> Control	C017311041
High-Temp Disinfection, 0.1 – 19 % O <sub>2</sub> Control, 4-Split Inner Door	C017314041
High-Temp Disinfection, 0.1 – 19 % O <sub>2</sub> Control, 4-Split Inner Door, Copper Chamber	C017314051
High-Temp Disinfection, 0.1 – 19 % O <sub>2</sub> Control, 4-Split Inner Door, Humidity Package	C017314061
High-Temp Disinfection, 0.1 – 19 % O <sub>2</sub> Control, 8-Split Inner Door	C017318041
High-Temp Disinfection, 1 – 19 % O <sub>2</sub> Control, Humidity Package	C017331011
High-Temp Disinfection, 1 – 19 % O <sub>2</sub> Control, Copper Chamber	C017331021
High-Temp Disinfection, 1 – 19 % O <sub>2</sub> Control, Humidity Package, Copper Chamber	C017331031
High-Temp Disinfection, 1 – 19 % O <sub>2</sub> Control, 4-Split Inner Door, Humidity Package	C017334011
High-Temp Disinfection, 1 – 19 % O <sub>2</sub> Control, 4-Split Inner Door, Copper Chamber	C017334021
High-Temp Disinfection, 1 – 19 % O <sub>2</sub> Control, 4-Split Inner Door, Humidity Package, Copper Chamber	C017334031
High-Temp Disinfection, 1 – 19 % O <sub>2</sub> Control, 8-Split Inner Door	C017338001
High-Temp Disinfection, 1 – 19 % O <sub>2</sub> Control, 8-Split Inner Door, Humidity Package	C017338011
High-Temp Disinfection, 1 – 19 % O <sub>2</sub> Control, 8-Split Inner Door, Humidity Package, Copper Chamber	C017338031
High-Temp Disinfection, Humidity Package	C017311011
High-Temp Disinfection, Copper Chamber	C017311021
High-Temp Disinfection, Humidity Package, Copper Chamber	C017311031
High-Temp Disinfection, 4-Split Inner Door, Humidity Package	C017314011
High-Temp Disinfection, 4-Split Inner Door, Copper Chamber	C017314021
High-Temp Disinfection, 4-Split Inner Door, Humidity Package, Copper Chamber	C017314031
High-Temp Disinfection, 8-Split Inner Door	C017318001
High-Temp Disinfection, 8-Split Inner Door, Humidity Package	C017318011
High-Temp Disinfection, 8-Split Inner Door, Humidity Package, Copper Chamber	C017318031

✎ Ordering information for other voltage options begins on page 434

For more information go to [www.eppendorf.com](http://www.eppendorf.com)



# Galaxy<sup>®</sup> 170 S

## Description

Galaxy 170 S CO<sub>2</sub> incubators are high-capacity, 170 liter incubators that provide excellent quality, outstanding performance, and intuitive operation. These models can be conveniently placed on or under the bench or even double-stacked. Galaxy 170 S models provide a tremendous amount of usable space that can be optimized with options such as High Temperature Disinfection and split inner doors.

### Product features

- > Standard features: Sealed inner glass door, reliable IR CO<sub>2</sub> sensor, RS-232 communication port, 25 mm access ports
- > High Temperature Disinfection (4 hour at 120 °C) optional
- > Available with split inner doors
- > Fanless design offers more usable space and eliminates the fan as a classic, and often repeated source of contamination
- > Six-sided direct heating system provides a uniform incubated environment
- > Deep-drawn, easy-to-clean stainless steel chamber eliminates seams or welds, removing potential sources of contamination
- > Low gas consumption



Accessory stacking stand available to expand chamber capacity in labs with limited space

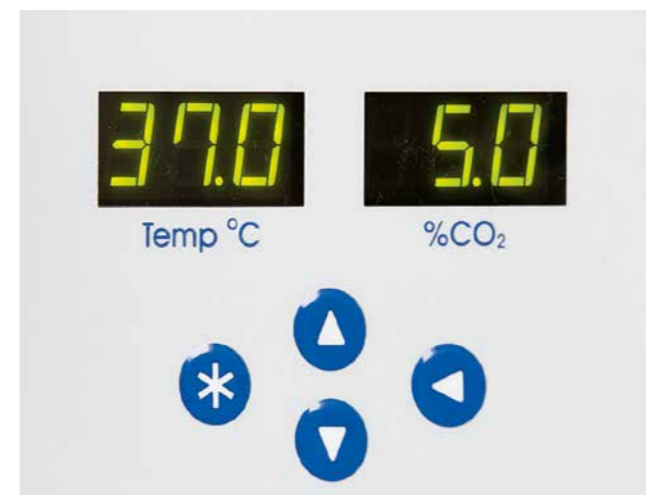

Galaxy<sup>®</sup> S Series LED Display, standard on 170 S



Optional split-inner doors provide easy access to your samples without completely opening the chamber

### Ordering information

Description	Order no.
Galaxy <sup>®</sup> 170 S, 170 L, Stock, 230 V/50/60 Hz	
Standard	C017101001
High-Temp Disinfection	C017111001
High-Temp Disinfection, 4-Split Inner Door	C017114001
Galaxy <sup>®</sup> 170 S, 170 L, Built to Order, 230 V/50/60 Hz	
Standard, 4-Split Inner Door	C017104001

✎ Ordering information for other voltage options begins on page 434

For more information go to [www.eppendorf.com](http://www.eppendorf.com)

# New Brunswick™ S41i

## Description

The New Brunswick S41i is the only CO<sub>2</sub> incubator with an Eppendorf shaker inside. The S41i precisely controls temperature, shaking speed, and CO<sub>2</sub>, providing the ideal environment for growing mammalian and stem cells in culture. Accepts flasks up to 4 liters. Standard perforated shelf allows for static incubation at the same time as shaking and a second static shelf can be added as an option. Renowned triple eccentric drive provides stable, uniform and vibration-free motion connected to the shaking platform by four encapsulated support rods. The drive mechanism located below the chamber ensures that heat generated by the drive does not affect the critical environment within the chamber. The intuitive touch screen display and controls allows you to operate and monitor performance.



## Product features

- > Temperature range from 4 °C above ambient to 50 °C
- > Shaking speeds between 25 – 400 rpm, 25 – 300 rpm if stacked
- > Large 35.6 × 61 cm (14 in × 24 in) platform accommodates flasks up to 4 liters providing flexibility with your cultures
- > Single or double stacked for increased capacity
- > Inner and outer door saves valuable gass while maintaining the perfect environment for your cells
- > Standard High Temperature Disinfection provides a sterile surface protecting your cells
- > Intuitive touch screen controls provides for precise control of the culturing environment
- > Perforated shelf allows for static incubation at the same time as shaking

New Brunswick™ S41i	
Universal platform	M1334-9920
125 mL Erlenmeyer flasks	20
250 mL Erlenmeyer flasks	16
500 mL Erlenmeyer flasks	12
1 L Erlenmeyer flasks	10
2 L Erlenmeyer flasks	4
2 L Lauber Thompson	4
2.8 L Fernbach flasks	3
3 L Erlenmeyer flasks	3
4 L Erlenmeyer flasks	3
Test tube rack, small, 30.0 x 8.0 x 12.9 cm	6
Test tube rack, medium, 36 x 8 x 12.9 cm	3
Test tube rack, large, 45 x 8 x 12.9 cm	3
Platform size	36 x 61 cm (14 x 24 in)

Ordering information of flask clamps and test tube racks can be found on page 327



## Applications

- > Culturing of suspension cells requiring gentle agitation
- > Incubating adherent cells on the shelf included with the unit: adding a 2nd static shelf and using the shaking platform as a 3rd shelf
- > Adherent cells such as stem cells that require both incubation and periodic gentle shaking

## Ordering information

Description	Order no.
<b>New Brunswick™ S41i</b> , 170 L, CO <sub>2</sub> incubator shaker with inner shelf and touch screen control, 1 shelf, 1 (2. optional) shelves, 230 V/50 Hz, orbit diameter 2.5 cm (1 in)	S41I230011
<b>Interchangeable platform for New Brunswick™ S41i</b> , 35.6 × 61 cm (14 × 24 in)	
Universal platform	M1334-9920
125 mL Erlenmeyer flask dedicated platform, comes complete with 32 clamps installed	M1334-9921
250 mL Erlenmeyer flask dedicated platform, comes complete with 24 clamps installed	M1334-9922
500 mL Erlenmeyer flask dedicated platform, comes complete with 15 clamps installed	M1334-9923
1 L Erlenmeyer flask dedicated platform, comes complete with 11 clamps installed	M1334-9924
2 L Erlenmeyer flask dedicated platform, comes complete with 6 clamps installed	M1334-9925
2.8 L Erlenmeyer flask dedicated platform, comes complete with 3 clamps installed	M1334-9926
4 L Erlenmeyer flask dedicated platform, comes complete with 3 clamps installed	M1334-9927
<b>Stacking kit</b> , allows up to 2 each New Brunswick™ S41i shakers to be stacked one on top of the other	P0628-6502
<b>Additional shelf for New Brunswick™ S41i</b> , perforated, can easily be added to the New Brunswick S41i for static cell culture of adherent cells	P0628-6181
<b>Sticky pad adaptor kit</b> , 2 anodized aluminum sheets, each 15.2 x 45.7 cm (6 x 18 in)	M1250-9504
<b>Sticky pad</b> , 20 x 20 cm (8 x 8 in)	M1250-9700

⚡ Ordering information for other voltage options begins on page 434

## BioCommand® SFI Automated Data Logging Software

### Description

The BioCommand SFI software package is designed specifically for standard laboratory equipment including shakers and CO<sub>2</sub> incubators. The software package allows you to track key operational information such as time, temperature, shaking speed, CO<sub>2</sub> concentrations and humidity.

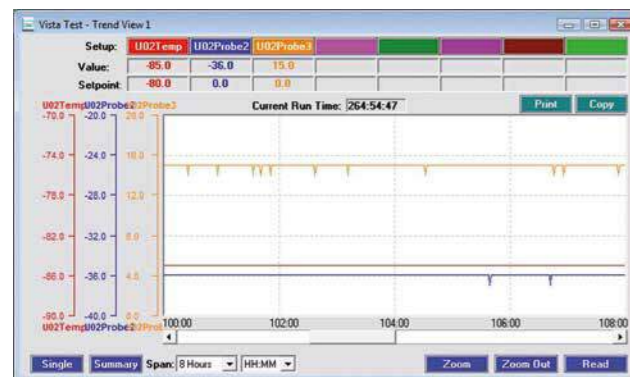

Graphical representation of the output

### Product features

- > Track the operational parameters of your choice with the option to design and save templates
- > Monitor multiple units from the same PC
- > Trend and archive critical data including temperature, agitation speed and gas concentration for up to 32 units simultaneously
- > Provides indications of alarm conditions identified by the product
- > Ability to email or text message alarm events

### Ordering information

Description	Order no.
BioCommand® SFI Automated Data Logging Software	
CO <sub>2</sub> incubator package	M1291-1001
CO <sub>2</sub> incubator cable, 4.5 m	P0620-7012
RS-232 to USB converter, 4-port	P0460-7751
RS-232 to USB converter, 8-port	P0460-7750

## CO<sub>2</sub> Incubators Accessories

### CO<sub>2</sub> Incubators Accessories

Description	Order no.
Galaxy® CO <sub>2</sub> , O <sub>2</sub> and RH gas analyzer	P0628-7890
O <sub>2</sub> Sensor, for Galaxy® CO <sub>2</sub> Incubator	P0628-5790
CO <sub>2</sub> supply line filters (2)	P0628-5020
Autozero port filter	P0628-5060
CO <sub>2</sub> cylinder auto-changeover controller	P0628-5000
Temperature probe, 5 mm tip for gas analyzer	P0628-7881
Temperature probe, 100 mm tip for gas analyzer	P0628-7880
Galaxy® CO <sub>2</sub> gas analyzer	P0628-6150
Galaxy® CO <sub>2</sub> and O <sub>2</sub> gas analyzer	P0628-6831

### Galaxy® 48 R shelves, pans and stacking stand

Description	Order no.
Lower stacking frame, with casters	6705 070.103
Upper stacking frame	6705 070.111
Under-bench stand	6705 070.120
2-split inner door	6705 851.040
Multi-position shelf rack, 6 position	6705 851.016
Additional shelf, perforated	P0628-5080
Additional humidity tray, stainless steel	P0628-5940

### Galaxy® 170 R/170 S, shelves, pans and stacking stand

Description	Order no.
Mid/upper stacking frame	6710 070.200
Lower stacking frame, with casters	6710 070.219
4-split Inner glass door, retrofittable	6710 866.005
8-split Inner glass door, retrofittable	6710 866.008
Additional shelves (2), perforated	6710 859.009
Multi-position shelf rack, 8 position, (standard on Galaxy® 170 R, optional on Galaxy® 170 S)	P0628-6390
Additional humidity tray, copper	P0628-6260
Additional humidity tray, stainless steel	P0628-6140

## CO<sub>2</sub> Incubators Accessories

### CO<sub>2</sub> Incubators Accessories

Description	Order no.
Galaxy® CO <sub>2</sub> , O <sub>2</sub> and RH gas analyzer	P0628-7890
O <sub>2</sub> Sensor, for Galaxy® CO <sub>2</sub> Incubator	P0628-5790
CO <sub>2</sub> supply line filters (2)	P0628-5020
Autozero port filter	P0628-5060
CO <sub>2</sub> cylinder auto-changeover controller	P0628-5000
Temperature probe, 5 mm tip for gas analyzer	P0628-7881
Temperature probe, 100 mm tip for gas analyzer	P0628-7880
Galaxy® CO <sub>2</sub> gas analyzer	P0628-6150
Galaxy® CO <sub>2</sub> and O <sub>2</sub> gas analyzer	P0628-6831

### Galaxy® 48 R shelves, pans and stacking stand

Description	Order no.
Lower stacking frame, with casters	6705 070.103
Upper stacking frame	6705 070.111
Under-bench stand	6705 070.120
2-split inner door	6705 851.040
Multi-position shelf rack, 6 position	6705 851.016
Additional shelf, perforated	P0628-5080
Additional humidity tray, stainless steel	P0628-5940

### Galaxy® 170 R/170 S, shelves, pans and stacking stand

Description	Order no.
Mid/upper stacking frame	6710 070.200
Lower stacking frame, with casters	6710 070.219
4-split Inner glass door, retrofittable	6710 866.005
8-split Inner glass door, retrofittable	6710 866.008
Additional shelves (2), perforated	6710 859.009
Multi-position shelf rack, 8 position, (standard on Galaxy® 170 R, optional on Galaxy® 170 S)	P0628-6390
Additional humidity tray, copper	P0628-6260
Additional humidity tray, stainless steel	P0628-6140

# Cell Handling



Model	Innova® 40/40R	Innova® 42/42R	Innova® 43/43R
Page(s)	314	315	316
Dimensions (W x D x H)	55.9 x 76.2 x 61 cm / 22 x 30 x 24 in	62 x 75.4 x 82 cm / 32.3 x 29.7 x 32.3 in	115.6 x 81.3 x 103.1 cm / 45.5 x 20 x 40.6 in
External height (with lid/door open)	101.6 cm (40 in)		165.1 cm (65 in)
External depth (with lid/door open)		131 cm (51.6 in)	
Weight w/o accessories	60 kg / 133 lb	99 kg / 217 lb	202 kg / 445 lb
Audible and visual alarms	yes	yes	yes
Available program modes	> Constant speed and temperature > Programmable multi-steps > RS-232 communication port	> Constant speed and temperature > Programmable multi-steps > RS-232 communication port	> Constant speed and temperature > Programmable multi-steps > RS-232 communication port
Drive mechanism	Triple-eccentric	Triple-eccentric	Triple-eccentric
cETLus and CE marked	yes	yes	yes
Benchtop (B), Under Bench (U), Floor (F) or Stackable (S)	B	B, U, S (x2)	F
Memory	Non volatile with automatic power failure restart	Non volatile with automatic power failure restart	Non volatile with automatic power failure restart
Motor type	Solid state, DC brushless motor	Solid state, DC brushless motor	Solid state, DC brushless motor
Platform size	46 x 46 cm (18 x 18 in)	46 x 46 cm (18 x 18 in)	76 x 46 cm (30 x 18 in)
Slide-out platform			
Space-saving glide-up doors			
Speed range	25 – 500 rpm	25 – 400 rpm; 25 – 300 rpm when stacked and using flasks larger than 500 mL	25 – 500 rpm with 2.5 cm orbit; 25 – 300 rpm with 5.1 cm orbit
Steps per program	15	15	15
Stored programs	4	4	4
Temperature range	5 °C above ambient to 80 °C. (Innova 40R: 15 °C below ambient to 80 °C)	5 °C above ambient to 80 °C. (Innova 42R: 20 °C below ambient to 80 °C)	5 °C above ambient to 80 °C. (Innova 43R: 20 °C below ambient to 80 °C)
Temperature uniformity	±0.25 °C at 37 °C	±0.25 °C at 37 °C	±0.25 °C at 37 °C
Timer	0.01 – 99.59 h, continuous	0.01 – 99.59 h, continuous	0.01 – 99.59 h, continuous
Orbit	1.9/2.5 cm (0.75/1 in)	1.9/2.5 cm (0.75/1 in)	2.5/5.1 cm (1/2 in)



Model	Innova® 44/44R	Innova® S44i	Excella® E24/E24R	Excella® E25/E25R
Page(s)	317	318	320	321
Dimensions (W x D x H)	135 x 87.3 x 66 cm / 53.1 x 33.2 x 26 in	118.2 x 95.8 x 63.1 cm / 46.5 x 37.7 x 24 in	56 x 76.2 x 61 cm / 22 x 30 x 24 in	127 x 77 x 105.9 cm / 50 x 30.5 x 41.7 in
External height (with lid/door open)	119.3 cm (47 in)	115.8 cm (45.6 in)	101.6 cm (40 in)	165.1 cm (65 in)
External depth (with lid/door open)				
Weight w/o accessories	238 kg / 525 lb	198 kg / 437 lb	60 kg / 133 lb	171 kg / 377 lb
Audible and visual alarms	yes	yes	yes	yes
Available program modes	> Constant speed and temperature > Programmable multi-steps > RS-232 communication port	> Constant speed and temperature > Timed mode up to 95:59 hours > Programming mode with multiple steps and cycling of program	> Constant speed and temperature > Timed shaking	> Constant speed and temperature > Timed shaking
Drive mechanism	Triple-eccentric	Eppendorf X-Drive with semi-automated counterbalance	Heavy-duty with permanently lubricated ball bearings	Heavy-duty with automatic power failure restart
cETLus and CE marked	yes	yes	yes	yes
Benchtop (B), Under Bench (U), Floor (F) or Stackable (S)	F, S (x3)	F, S (x3)	B	F
Memory	Non volatile with automatic power failure restart	Non volatile with automatic power failure restart	Non volatile with automatic power failure restart	Non volatile with automatic power failure restart
Motor type	Solid state, DC brushless motor	Solid state, DC brushless motor	Solid state, DC brushless motor	Solid state, DC brushless motor
Platform size	76 x 46 cm (30 x 18 in)	76 x 62 cm (30 x 24 in)	46 x 46 cm (18 x 18 in)	76 x 46 cm (30 x 18 in)
Slide-out platform	yes	yes		
Space-saving glide-up doors	yes	yes		
Speed range	25 – 400 rpm with 2.5 cm orbit; 25 – 300 rpm with 5.1 cm orbit or 2 stacked units; 25 – 250 rpm with 3 stacked units	2.5 cm orbit: 20 – 400 rpm adjustable at 1 rpm increment; 5.1 cm orbit: 20 – 300 rpm at 1 rpm increment	50 – 400 rpm	50 – 400 rpm
Steps per program	15	unlimited		
Stored programs	4	unlimited		
Temperature range	5 °C above ambient to 80 °C. (Innova 44R: 20 °C below ambient to 80 °C)	Incubated: 5 °C above ambient to 80 °C; Refrigerated: 20 °C below ambient (min. 4 °C) to 80 °C.	7 °C above ambient to 60 °C. (Excella 24R: 15 °C below ambient to 60 °C)	7 °C above ambient to 60 °C. (Excella 25R: 15 °C below ambient to 60 °C)
Temperature uniformity	±0.25 °C at 37 °C	±0.25 °C at 37 °C and 250 rpm	±0.5 °C at 37 °C	±0.5 °C at 37 °C
Timer	0.01 – 99.59 h, continuous	0.01 – 95.59 h, continuous	0.1 – 99.9 h	0.1 – 99.9 h
Orbit	2.5/5.1 cm (1/2 in)	2.5/5.1 cm (1/2 in)	1.9 cm (0.75 in)	2.5 cm (1 in)

i For more information go to [www.eppendorf.com](http://www.eppendorf.com)

Technical specifications subject to change.

**epServices** for premium performance On page 382 you will find detailed information on services for these products!

Your local distributor: [www.eppendorf.com/contact](http://www.eppendorf.com/contact)  
Eppendorf AG · Barkhausenweg 1 · 22339 Hamburg · Germany · [eppendorf@eppendorf.com](mailto:eppendorf@eppendorf.com) · [www.eppendorf.com](http://www.eppendorf.com)



<b>Model</b>	Innova® 2000
<b>Page(s)</b>	323
<b>Dimensions (W x D x H)</b>	35.5 x 37 x 14.6 cm / 14 x 14.5 x 5.8 in
<b>Weight w/o accessories</b>	15 kg / 33 lb
<b>Audible and visual alarms</b>	yes
<b>Balanced drive mechanism</b>	Triple-eccentric with permanently lubricated ball bearings
<b>cETLus and CE marked</b>	yes
<b>Benchtop (B), Under Bench (U), Floor (F) or Stackable (S)</b>	B
<b>Motor type</b>	Solid state, DC brushless motor
<b>Orbit</b>	1.9 cm (0.75 in)
<b>Platform size</b>	33 x 28 cm (13 x 11 in)
<b>Timer</b>	0.1 – 99.9 h



<b>Model</b>	Innova® 2150
<b>Page(s)</b>	324
<b>Dimensions (W x D x H)</b>	60.1 x 59.1 x 16.3 cm / 24 x 23.3 x 6.4 in
<b>Weight w/o accessories</b>	36 kg / 80 lb
<b>Audible and visual alarms</b>	yes
<b>Balanced drive mechanism</b>	Triple-eccentric with permanently lubricated ball bearings
<b>cETLus and CE marked</b>	yes
<b>Benchtop (B), Under Bench (U), Floor (F) or Stackable (S)</b>	B
<b>Motor type</b>	Solid state, DC brushless motor
<b>Orbit</b>	1.9 cm (0.75 in)
<b>Platform size</b>	61 x 46 cm (24 x 18 in)
<b>Timer</b>	0.1 – 99.9 h

i For more information go to [www.eppendorf.com](http://www.eppendorf.com)

Technical specifications subject to change.



<b>Model</b>	Innova® 2050
<b>Page(s)</b>	323
<b>Dimensions (W x D x H)</b>	43 x 37 x 14.6 cm / 17 x 14.5 x 5.8 in
<b>Weight w/o accessories</b>	16 kg / 35 lb
<b>Audible and visual alarms</b>	yes
<b>Balanced drive mechanism</b>	Triple-eccentric with permanently lubricated ball bearings
<b>cETLus and CE marked</b>	yes
<b>Benchtop (B), Under Bench (U), Floor (F) or Stackable (S)</b>	B
<b>Motor type</b>	Solid state, DC brushless motor
<b>Orbit</b>	1.9 cm (0.75 in)
<b>Platform size</b>	41 x 31 cm (16 x 12 in)
<b>Timer</b>	0.1 – 99.9 h



<b>Model</b>	Innova® 2300
<b>Page(s)</b>	325
<b>Dimensions (W x D x H)</b>	76.2 x 56.6 x 16.3 cm / 30 x 22.3 x 6.4 in
<b>Weight w/o accessories</b>	48 kg / 105 lb
<b>Audible and visual alarms</b>	yes
<b>Balanced drive mechanism</b>	Triple-eccentric with permanently lubricated ball bearings
<b>cETLus and CE marked</b>	yes
<b>Benchtop (B), Under Bench (U), Floor (F) or Stackable (S)</b>	B
<b>Motor type</b>	Solid state, DC brushless motor
<b>Orbit</b>	2.5/5.1 cm (1/2 in)
<b>Platform size</b>	76 x 46 cm (30 x 18 in)
<b>Timer</b>	0.1 – 99.9 h



On page 382 you will find detailed information on services for these products!

Your local distributor: [www.eppendorf.com/contact](http://www.eppendorf.com/contact)  
Eppendorf AG · Barkhausenweg 1 · 22339 Hamburg · Germany · [eppendorf@eppendorf.com](mailto:eppendorf@eppendorf.com) · [www.eppendorf.com](http://www.eppendorf.com)



<b>Model</b>	Innova® 2100
<b>Page(s)</b>	324
<b>Dimensions (W x D x H)</b>	48 x 55.5 x 16.3 cm / 19 x 21.9 x 6.4 in
<b>Weight w/o accessories</b>	34 kg / 75 lb
<b>Audible and visual alarms</b>	yes
<b>Balanced drive mechanism</b>	Triple-eccentric with permanently lubricated ball bearings
<b>cETLus and CE marked</b>	yes
<b>Benchtop (B), Under Bench (U), Floor (F) or Stackable (S)</b>	B
<b>Motor type</b>	Solid state, DC brushless motor
<b>Orbit</b>	1.9 cm (0.75 in)
<b>Platform size</b>	46 x 46 cm (18 x 18 in)
<b>Timer</b>	0.1 – 99.9 h



<b>Model</b>	Innova® 2350
<b>Page(s)</b>	325
<b>Dimensions (W x D x H)</b>	91.4 x 61 x 16.3 cm / 36 x 24 x 6.4 in
<b>Weight w/o accessories</b>	52 kg / 115 lb
<b>Audible and visual alarms</b>	yes
<b>Balanced drive mechanism</b>	Triple-eccentric with permanently lubricated ball bearings
<b>cETLus and CE marked</b>	yes
<b>Benchtop (B), Under Bench (U), Floor (F) or Stackable (S)</b>	B
<b>Motor type</b>	Solid state, DC brushless motor
<b>Orbit</b>	2.5/5.1 cm (1/2 in)
<b>Platform size</b>	91 x 61 cm (36 x 24 in)
<b>Timer</b>	0.1 – 99.9 h

## New Brunswick™ Innova® 40/40R

### Description

The Innova 40 incubated and 40R incubated and refrigerated benchtop shakers provide years of dependable operation. The cast iron Eppendorf triple-eccentric counterbalanced drive is specifically designed to support high-speed applications and heavy workloads. Innova 40 incubated shakers provide very broad temperature capabilities for culturing a wide variety of organisms in flasks up to 3 L. A Refrigeration module is built into the Innova 40R.



### Product features

- > Triple-eccentric counterbalanced drive in cast iron housing provides vibration and trouble-free operation for years
- > Compact benchtop model – fits easily on the bench and holds flasks up to 3 L
- > Clear cover allows easy viewing of the cultures and lifts easily to access all samples
- > Versatile accessory platform (sold separately) accommodates flasks up to 3 L as well as test tube racks and microplate holders
- > Certified. Meets cETL, UL, CSA and CE standards

### Ordering information

Description	Order no.
<b>New Brunswick™ Innova® 40</b>	
230 V/50 Hz, orbit diameter 1.9 cm (3/4 in)	M1299-0082
230 V/50 Hz, orbit diameter 2.5 cm (1 in)	M1299-0092
<b>New Brunswick™ Innova® 40R</b>	
230 V/50 Hz, orbit diameter 1.9 cm (3/4 in)	M1299-0086
230 V/50 Hz, orbit diameter 2.5 cm (1 in)	M1299-0096
<b>Remote alarm</b>	M1320-8029
<b>Platform for Innova® 2100/40/40R/42/42R, Excella® E24/E24R, 45.7 × 45.7 cm, phenolic resin</b>	
Universal platform, aluminum	M1250-9902
50 mL Erlenmeyer flask dedicated platform	M1194-9903
125 mL Erlenmeyer flask dedicated platform	M1194-9904
250 mL Erlenmeyer flask dedicated platform	M1194-9905
500 mL Erlenmeyer flask dedicated platform	M1194-9906
1 L Erlenmeyer flask dedicated platform	M1194-9907
2 L Erlenmeyer flask dedicated platform	M1194-9908
Sticky pad platform, sticky pads sold separately	M1250-9903
<b>Quick-change platform kit</b> , enables platform attachment without tools	M1192-9901
<b>Utility carrier</b> , holds racks and vessels between rubber-cushioned cross bars	M1194-9909
<b>Utility tray</b> , with non-skid rubber surface	M1194-9910
<b>Rod kit</b> , for utility carrier (one additional rod)	M1194-9923
<b>Drip pan</b> , for universal platform M1250-9902	M1250-9906

Ordering information for other voltage options begins on page 434

## New Brunswick™ Innova® 42/42R

### Description

The Innova 42 incubated and 42R incubated and refrigerated shakers are our most versatile incubator shakers. The programmable Innova 42 and 42R provide exceptional convenience allowing you to simultaneously shake and static incubate cultures under the same conditions. Use on or under the bench, or double stacked for space savings. An optional culture drawer, gassing manifold, remote alarm, and humidity monitor are available for both models; a photosynthetic light bank and UV germicidal light are available for the 42R.



### Product features

- > Cast iron triple-eccentric counterbalanced drive provides years of dependable operation
- > Programmable Innova controls automatically changes temperature, speed, and optional photosynthetic and UV germicidal lights at timed intervals
- > Large viewing window and internal light provide easy viewing of samples without the need to open the door
- > Built-in water reservoir humidifies chamber to reduce sample evaporation, while also protecting unit from spills and including a drain for easy cleaning
- > Versatile accessory platforms (sold separately) accommodates flasks up to 4 L as well as test tube racks and microplate holders

### Ordering information

Description	Order no.
<b>New Brunswick™ Innova® 42</b>	
230 V/50 Hz, orbit diameter 1.9 cm (3/4 in)	M1335-0002
230 V/50 Hz, orbit diameter 2.5 cm (1 in)	M1335-0012
<b>New Brunswick™ Innova® 42R</b>	
230 V/50 Hz, orbit diameter 1.9 cm (3/4 in)	M1335-0006
230 V/50 Hz, orbit diameter 2.5 cm (1 in)	M1335-0016
<b>Photosynthetic light bank</b> , programmable, Innova® 42R only, orbit diameter 1.9/2.5 cm (0.75/1 in)	M1335-0300
<b>UV germicidal light</b> , programmable, Innova® 42R only, orbit diameter 1.9/2.5 cm (0.75/1 in)	M1335-0400
<b>Humidity monitor</b> , for Innova® 42/42R, orbit diameter 1.9/2.5 cm (0.75/1 in)	M1335-0500
<b>12-port gassing manifold</b> , for Innova® 42/42R, orbit diameter 1.9/2.5 cm (0.75/1 in)	M1335-0600
<b>Platform for Innova® 2100/40/40R/42/42R, Excella® E24/E24R, 45.7 × 45.7 cm, phenolic resin</b>	
Universal platform, aluminum	M1250-9902
Sticky pad platform, sticky pads sold separately	M1250-9903
<b>Quick-change platform kit</b> , enables platform attachment without tools	M1192-9901
<b>Stacking kit</b> , for stacking Innova® 42/42R units	M1335-0800
<b>Utility carrier</b> , holds racks and vessels between rubber-cushioned cross bars	M1194-9909
<b>Stacking kit</b> , for stacking Innova® 4200/4230 units on top of Innova® 42/42R shakers	M1335-0810
<b>Rod kit</b> , for utility carrier (one additional rod)	M1194-9923
<b>Additional perforated shelf and brackets</b> , for Innova® 42/42R	M1335-0080
<b>Remote alarm</b>	M1320-8029
50 mL Erlenmeyer flask dedicated platform	M1194-9903
125 mL Erlenmeyer flask dedicated platform	M1194-9904
250 mL Erlenmeyer flask dedicated platform	M1194-9905
500 mL Erlenmeyer flask dedicated platform	M1194-9906
1 L Erlenmeyer flask dedicated platform	M1194-9907
2 L Erlenmeyer flask dedicated platform	M1194-9908
<b>Culture drawer</b> , prevents plates from drying	M1335-0501
<b>Utility tray</b> , with non-skid rubber surface	M1194-9910
<b>Drip pan</b> , for universal platform M1250-9902	M1250-9906

Ordering information for other voltage options begins on page 434

## New Brunswick™ Innova® 43/43R

### Description

The Innova 43 incubated and Innova 43R incubated and refrigerated shakers are the perfect choice for handling large quantities or large volumes of cultures with precision and ease. The cast iron triple-eccentric counterbalanced drive is specifically designed to support high-speed applications and heavy workloads.



### Product features

- > Console style shaker/incubator with triple-eccentric drive – provides large capacity shaking for flasks up to 6 L
- > Programmable Innova controls – automatically changes temperature, speed, and optional photosynthetic and UV germicidal lights at timed intervals
- > Top mounted controls and display – for easy, ergonomic viewing and setting
- > Foot pedal release with easy opening lid – provides hands-free operation
- > RS-232 port for data logging
- > Built-in water reservoir humidifies chamber to reduce sample evaporation while also protecting unit from spills and including a drain for easy cleaning

### Ordering information

Description	Order no.
<b>New Brunswick™ Innova® 43</b>	
230 V/50 Hz, orbit diameter 2.5 cm (1 in)	M1320-0002
230 V/50 Hz, orbit diameter 5.1 cm (2 in)	M1320-0012
<b>New Brunswick™ Innova® 43R</b>	
230 V/50 Hz, orbit diameter 2.5 cm (1 in)	M1320-0006
230 V/50 Hz, orbit diameter 5.1 cm (2 in)	M1320-0016
<b>Photosynthetic light bank</b> , for Innova® 43R only	M1320-0300
<b>UV germicidal light</b> , in the airflow path outside the chamber reduces the bio-burden of circulated air, Innova® 43R only	M1320-0400
<b>12-port gassing manifold</b> , permits direct gassing into flasks	M1320-0500
<b>Humidity monitor</b>	M1320-0600
<b>Platform for Innova® 2300/43/43R, Excella® E10/E25/E25R</b> , 76 x 46 cm, aluminum	
Sticky pad platform, sticky pads sold separately	M1250-9904
<b>Utility tray</b> , with non-skid rubber surface	AG-00
<b>Remote alarm</b>	M1320-8029
Universal platform	M1250-9920
50 mL Erlenmeyer flask dedicated platform	M1191-9908
125 mL Erlenmeyer flask dedicated platform	M1191-9909
250 mL Erlenmeyer flask dedicated platform	M1191-9910
500 mL Erlenmeyer flask dedicated platform	M1191-9911
1 L Erlenmeyer flask dedicated platform	AG-1
2 L Erlenmeyer flask dedicated platform	AG-2
2.8 L Fernbach flask dedicated platform	AG-28
6 L Erlenmeyer flask dedicated platform	AG-6

Ordering information for other voltage options begins on page 434

## New Brunswick™ Innova® 44/44R

### Description

The Innova 44 incubated and 44R incubated and refrigerated shakers are stackable solutions that provide very broad temperature capabilities for culturing a wide variety of organisms in flasks up to 5 L. The cast iron triple-eccentric counterbalanced drive is specifically designed to support high-speed applications and heavy workloads. Refrigeration module is built into the Innova 44R, or can be easily added to 44, at any time.



### Product features

- > Stackable – up to three units for maximum space savings
- > Programmable Innova controls automatically change temperature, speed, and optional photosynthetic and UV germicidal lights at timed intervals
- > Versatile accessory platform (sold separately) accommodates flasks up to 5 L
- > Slide-out platform mechanism – provides easy and effortless access to flasks located in the front and back of the shaker
- > Built-in water reservoir humidifies chamber to reduce sample evaporation, while also protecting unit from spills, includes a drain for easy cleaning
- > Pull-out service module allows access to all electronic and heating/cooling components, without having to unstack the units

### Ordering information

Description	Order no.
<b>New Brunswick™ Innova® 44</b>	
230 V/50 Hz, orbit diameter 2.5 cm (1 in)	M1282-0002
230 V/50 Hz, orbit diameter 5.1 cm (2 in)	M1282-0012
<b>New Brunswick™ Innova® 44R</b>	
230 V/50 Hz, orbit diameter 2.5 cm (1 in)	M1282-0006
230 V/50 Hz, orbit diameter 5.1 cm (2 in)	M1282-0016
<b>Photosynthetic light bank</b> , for Innova® 44R only, orbit diameter 2.5/5.1 cm (1/2 in)	M1282-9922
<b>12-port gassing manifold</b> , for Innova® 44R, orbit diameter 2.5/5.1 cm (1/2 in)	M1282-0291
<b>Humidity monitor</b> , for Innova® 44R, orbit diameter 2.5/5.1 cm (1/2 in)	M1282-5011
<b>UV germicidal light</b> , for Innova® 44R only, orbit diameter 2.5/5.1 cm (1/2 in)	M1282-9921
<b>Aluminum platform for Innova® 44/44R</b> , 76 x 46 cm, not interchangeable with other 76 x 46 cm platforms	
Universal platform	M1282-9904
500 mL Erlenmeyer flask dedicated platform	M1282-9907
4 L Erlenmeyer flask dedicated platform	M1282-9911
Sticky pad platform, sticky pads sold separately	M1282-9913
<b>Heavy duty 0.95 cm-thick aluminum plate platform for Innova® 44/44R only</b> , 76 x 46 cm, not interchangeable with other 76 x 46 cm platforms. Heavy-duty platforms are recommended for shaking full loads of flasks, 1 L and larger, containing more than 20 % volume or with baffles	
Universal platform	M1282-9915
1 L Erlenmeyer flask dedicated platform	M1282-9925
2 L Erlenmeyer flask dedicated platform	M1282-9926
<b>Remote alarm</b> , for Innova® 44R	M1320-8029
<b>Aluminum platform for Innova® 44/44R</b> , 76 x 46 cm, not interchangeable with other 76 x 46 cm platforms	
125 mL Erlenmeyer flask dedicated platform	M1282-9905
250 mL Erlenmeyer flask dedicated platform	M1282-9906
1 L Erlenmeyer flask dedicated platform	M1282-9908
2 L Erlenmeyer flask dedicated platform	M1282-9909
2.8 L Fernbach flask dedicated platform	M1282-9910
<b>Base riser</b> , increases the height of the shaker for easier access, for Innova® 44/44R	
10.2 cm, short	M1282-0600
30.5 cm, medium	M1282-0800
40.6 cm, tall	M1282-0700
<b>Stacking kit</b> , for stacking one additional 44 or 44R	M1282-0500

# NEW - Innova<sup>®</sup> S44i

## Description

Innova S44i is a large capacity, stackable shaker with temperature control functionality. It is designed to provide maximum flask and weight capacity at a compact footprint. Eppendorf X-Drive with software-guided counterbalance adjustment supports smooth shaking of uneven and heavy loads at high speeds. All Innova S44i in a triple stack can be operated at maximum speed.

The Innova S44i supports the integration of the shaker in regulated labs with its easy-to-use touchscreen user interface with user management capability, USB ports to download operational data and Ethernet for addition to customer network. Service products including installation and operation qualification allow seamless validation of the instrument.



► This icon tags devices that are connectable to the Eppendorf VisioNize™ system. Further information are available at pages 12 – 13.

1. High flask capacity in a smaller footprint to grow more cells in less space – 33 % more 500 mL flask capacity and 80 % more weight capacity than Innova 44
2. The new Eppendorf X-Drive with semi-automated counterbalance technology for smooth and vibration-free agitation
3. Double- or triple- stack the S44i for increased capacity
4. Intuitive touchscreen interface with unlimited programming and user management capability
5. New slide-out platform design with quick-release handle provides easy access to samples even at the back of the platform
6. Glide-up door for convenient and effortless chamber access
7. Easily reach all your samples using the slide-out platform
8. Photosynthetic LED light bank option provides uniform light across the platform for cyanobacteria and algae culture

## Applications

- > Grow bacteria, yeast, fungus, cyanobacteria and algae
- > Plasmid DNA production and protein expression
- > Process and media development
- > Media screening and optimization
- > Seed cultures for bioprocess scale-up
- > Biofuel research
- > Food quality testing

## Ordering information

Description	Order no.
Innova <sup>®</sup> S44i, incubated, 230 V/50/60 Hz, orbit diameter 2.5 cm (1 in)	S44i300001
Innova <sup>®</sup> S44i, refrigerated, 230 V/50/60 Hz, orbit diameter 2.5 cm (1 in)	S44i310001
Innova <sup>®</sup> S44i, refrigerated, photosynthetic LED light bank, 230 V/50/60 Hz, orbit diameter 2.5 cm (1 in)	S44i311001
Innova <sup>®</sup> S44i, incubated, 230 V/50/60 Hz, orbit diameter 5.1 cm (2 in)	S44i320001
Innova <sup>®</sup> S44i, refrigerated, 230 V/50/60 Hz, orbit diameter 5.1 cm (2 in)	S44i330001
Innova <sup>®</sup> S44i, refrigerated, photosynthetic LED light bank, 230 V/50/60 Hz, orbit diameter 5.1 cm (2 in)	S44i331001

<sup>1)</sup> Maximum agitation speed of Innova<sup>®</sup> S44i reduced to 300 rpm when stacked on one Innova<sup>®</sup> 44/44R and 250 rpm when triple stacked



LED lamps with adjustable intensity for uniform coverage over entire platform



Eppendorf X-Drive with five eccentric mounting points and adjustable counterbalance provides dependable operation

Technical specifications	
Model	Innova <sup>®</sup> S44i
Agitation	
Orbit	2.5/5.1 cm (1/2 in)
Drive mechanism	Eppendorf X-Drive with semi-automated counterbalance
Speed	2.5 cm (1 in) orbit: 20 – 400 rpm 5.1 cm (2 in) orbit: 20 – 300 rpm
Maximum platform load	35.4 kg (78 lb)
Temperature range	Incubated: 5 °C above ambient to 80 °C; Refrigerated: 20 °C below ambient (min. 4 °C) to 80 °C.
Temperature accuracy	±0.1 °C at 37 °C
Temperature uniformity	±0.25 °C at 37 °C and 250 rpm
Available program modes	> Constant speed and temperature > Timed mode up to 95:59 hours > Programming mode with multiple steps and cycling of program
Communication port	USB and Ethernet
Dimensions (W × D × H)	118.2 × 95.8 × 63.1 cm / 46.5 × 37.7 × 24 in
Dimensions and weight	
Net weight	Incubated: 186 kg (411 lb) Refrigerated: 198 kg (437 lb)
Photosynthetic LED light bank	
Intensity range	15 to 150 par adjustable increments of 10 %
Main wavelength	Wide band spectrum; 400 – 700 nm

## Ordering information

Description	Order no.
Universal platform	S44i040001
125 mL Erlenmeyer flask dedicated platform, 86 clamps	S44i040002
250 mL Erlenmeyer flask dedicated platform, 53 clamps	S44i040003
500 mL Erlenmeyer flask dedicated platform, 39 clamps	S44i040004
1 L Erlenmeyer flask dedicated platform, 23 clamps	S44i040005
2 L Erlenmeyer flask dedicated platform, 15 clamps	S44i040006
2.8 L Fernbach flask dedicated platform, 8 clamps	S44i040007
4 L Erlenmeyer flask dedicated platform, 8 clamps	S44i040008
10.5 cm (4.1 in) positioning base	S44i041001
30.7 cm (12.1 in) positioning base	S44i041002
Stacking kit, double stack of Innova <sup>®</sup> S44i	S44i041005
Stacking kit, Innova <sup>®</sup> S44i to Innova <sup>®</sup> 44/44R, <sup>1)</sup>	S44i041006
Stacking kit, triple stack of Innova <sup>®</sup> S44i	S44i041003
Static incubation shelf	S44i042001
Darkening window shade	S44i042002

<sup>1)</sup> Maximum agitation speed of Innova<sup>®</sup> S44i reduced to 300 rpm when stacked on one Innova<sup>®</sup> 44/44R and 250 rpm when triple stacked

✦ Ordering information for other voltage options begins on page 434



## New Brunswick™ Excella® E24/E24R

### Description

The benchtop Excella E24 incubated and model E24R incubated and refrigerated shakers accommodate test tubes or flasks up to 2.8 L in a tightly-sealed growth chamber featuring a clear acrylic lid for excellent visibility of all samples. A wide variety of platforms, clamps, and test tube racks provide for unlimited flexibility. The Excella E24 and E24R offer field calibration of temperature and speed through the microprocessor-controlled touch pad.



### Product features

- > Heavy-duty counterbalanced drive provides long life, vibration-free, quiet, and dependable operation
- > Versatile accessory platform (sold separately) accommodates flasks up to 2.8 L as well as test tube racks and microplate holders
- > User-friendly keypad with large LED display is clearly visible and easy to set
- > Clear large lid provides excellent visibility minimizing the need to open the lid
- > Audible and visual alarms alert you to setpoint deviations or end of study
- > Acceleration/deceleration circuit prevents sudden starts and stops protecting your cells
- > Microprocessor controls precisely regulate temperature, speed and running time

### Ordering information

Description	Order no.
<b>New Brunswick™ Excella® E24</b>	
230 V/50 Hz, orbit diameter 1.9 cm (3/4 in)	M1352-0002
<b>New Brunswick™ Excella® E24R</b>	
230 V/50 Hz, orbit diameter 1.9 cm (3/4 in)	M1352-0006
<b>Platform for Innova® 2100/40/40R/42/42R, Excella® E24/E24R, 45.7 × 45.7 cm, phenolic resin</b>	
Universal platform, aluminum	M1250-9902
50 mL Erlenmeyer flask dedicated platform	M1194-9903
125 mL Erlenmeyer flask dedicated platform	M1194-9904
250 mL Erlenmeyer flask dedicated platform	M1194-9905
500 mL Erlenmeyer flask dedicated platform	M1194-9906
1 L Erlenmeyer flask dedicated platform	M1194-9907
2 L Erlenmeyer flask dedicated platform	M1194-9908
Sticky pad platform, sticky pads sold separately	M1250-9903
<b>Quick-change platform kit, enables platform attachment without tools</b>	M1192-9901
<b>Utility carrier, holds racks and vessels between rubber-cushioned cross bars</b>	M1194-9909
<b>Utility tray, with non-skid rubber surface</b>	M1194-9910
<b>Rod kit, for utility carrier (one additional rod)</b>	M1194-9923
<b>Spare parts kit, for E24 and E24R</b>	M1352-6000
<b>Drip pan, for universal platform M1250-9902</b>	M1250-9906

✎ Ordering information for other voltage options begins on page 434

## New Brunswick™ Excella® E25/E25R

### Description

The large console Excella E25 incubated and Excella E25R incubated and refrigerated shakers accommodate test tubes or flasks up to 6 L in a tightly-sealed growth chamber featuring a large viewing window for easy viewing of samples. A wide variety of platforms, clamps and test tube racks provide for unlimited flexibility. The Excella models E25 and E25R offer field calibration of temperature and speed through the microprocessor-controlled touch pad.



### Product features

- > Heavy-duty counterbalanced drive provides long life, vibration-free, quiet and dependable operation
- > Large platform size provides increased flexibility with the number and size of cultures (sold separately)
- > Large viewing window and internal light – for easy viewing of samples without the need to open the door
- > Microprocessor controls precisely regulate temperature, speed and running time
- > Audible and visual alarms alert you to setpoint deviations or end of study
- > Powerful fan and heater provide rapid heat up and temperature recovery after door opening

### Ordering information

Description	Order no.
<b>New Brunswick™ Excella® E25, 230 V/50 Hz, orbit diameter 2.5 cm (1 in)</b>	M1353-0002
<b>New Brunswick™ Excella® E25R, 230 V/50 Hz, orbit diameter 2.5 cm (1 in)</b>	M1353-0006
<b>Platform for Innova® 2300/43/43R, Excella® E10/E25/E25R, 76 × 46 cm, aluminum</b>	
Universal platform, aluminum	M1250-9920
50 mL Erlenmeyer flask dedicated platform	M1191-9908
125 mL Erlenmeyer flask dedicated platform	M1191-9909
250 mL Erlenmeyer flask dedicated platform	M1191-9910
500 mL Erlenmeyer flask dedicated platform	M1191-9911
1 L Erlenmeyer flask dedicated platform	AG-1
2 L Erlenmeyer flask dedicated platform	AG-2
2.8 L Fernbach flask dedicated platform	AG-28
6 L Erlenmeyer flask dedicated platform	AG-6
Sticky pad platform, sticky pads sold separately	M1250-9904
<b>Utility tray, with non-skid rubber surface</b>	AG-00

✎ Ordering information for other voltage options begins on page 434

## Open Air Shakers

### Description

For shaking in ambient conditions, on the bench, or in a warm or cold room, Innova Open Air Shakers are the instrument of choice. Dependable operation is due in large part to the Eppendorf triple-eccentric counterbalanced drive. Eppendorf offers a broad-based cast-iron support mechanism properly sized to each shaker and specifically designed to support high-speed applications and heavy workloads. Innova Open Air shakers are offered in 6 different sizes offering reliable, continuous-duty shaking of test tubes and flasks up to 6 L.



### Product features

- > Triple-eccentric counterbalanced drive in cast iron housing provides vibration and trouble-free operation for years
- > Quiet operation provides a favorable work environment
- > Shaking speeds between 25 – 500 rpm ( $\pm 1$  rpm) provide versatility for culturing a wide range of cell types
- > Speed controlled and displayed in increments of 1 rpm
- > Includes audible and visual alarms, timer (0 – 99.9 h) with continuous operation or automatic shut-off at the end of the study
- > Enclosed electronics and mechanical components prevent internal damage from accidental spills
- > Versatile 33 x 28 cm (13 x 11 in) accessory platform (sold separately) accommodates flasks up to 500 mL
- > Low profile - less than 6" (15 cm) tall-enables use of multiple shakers in an incubator or environmental chamber

For more information go to [www.eppendorf.com](http://www.eppendorf.com)

Technical specifications subject to change.

## New Brunswick™ Innova® 2000



### Ordering information

Description	Order no.
<b>New Brunswick™ Innova® 2000</b> , platform sold separately, 220/230 V/50/60 Hz, orbit diameter 1.9 cm (0.75 in)	M1190-0002
<b>Platform for Innova® 2000</b> , 33 x 28 cm, stainless steel	
Universal platform	M1001-0240
10 mL Erlenmeyer flask dedicated platform	AG2-10
25 mL Erlenmeyer flask dedicated platform	M1190-9919
50 mL Erlenmeyer flask dedicated platform	M1190-9915
125 mL Erlenmeyer flask dedicated platform	M1190-9916
250 mL Erlenmeyer flask dedicated platform	M1190-9917
500 mL Erlenmeyer flask dedicated platform	M1190-9918
<b>Utility carrier</b> , holds glassware between rubber-cushioned cross bars	AG2-UT
<b>Utility tray</b> , with non-skid rubber surface	AG2-00
<b>Rod kit</b> , for utility carrier (one additional rod)	M1001-9920
<b>Capacity upgrade kit</b> , to convert a Model 2000 to a Model 2050	M1190-9910
<b>Temperature and speed monitoring kit</b> , for recording on an external chart recorder	M1190-9909

Ordering information for other voltage options begins on page 434

## New Brunswick™ Innova® 2050



### Ordering information

Description	Order no.
<b>New Brunswick™ Innova® 2050</b> , platform sold separately, 220/230 V/50/60 Hz, orbit diameter 1.9 cm (0.75 in)	M1190-0012
<b>Platform for Innova® 2050</b> , 40.6 x 30.5 cm, stainless steel	
Universal platform	M1190-9900
10 mL Erlenmeyer flask dedicated platform	M1190-9901
25 mL Erlenmeyer flask dedicated platform	M1190-9902
50 mL Erlenmeyer flask dedicated platform	M1190-9903
125 mL Erlenmeyer flask dedicated platform	M1190-9904
250 mL Erlenmeyer flask dedicated platform	M1190-9905
500 mL Erlenmeyer flask dedicated platform	M1190-9906
1 L Erlenmeyer flask dedicated platform	M1190-9911
<b>Utility carrier</b> , holds glassware between rubber-cushioned cross bars	M1190-9907
<b>Utility tray</b> , with non-skid rubber surface	M1190-9908

Ordering information for other voltage options begins on page 434

## New Brunswick™ Innova® 2100



Ordering information	
Description	Order no.
<b>New Brunswick™ Innova® 2100</b> , platform sold separately, 220/230 V/50/60 Hz, orbit diameter 1.9 cm (0.75 in)	M1194-0002
<b>Platform for Innova® 2100/40/40R/42/42R, Excella® E24/E24R</b> , 45.7 × 45.7 cm, phenolic resin	
Universal platform, aluminum	M1250-9902
50 mL Erlenmeyer flask dedicated platform	M1194-9903
125 mL Erlenmeyer flask dedicated platform	M1194-9904
250 mL Erlenmeyer flask dedicated platform	M1194-9905
500 mL Erlenmeyer flask dedicated platform	M1194-9906
1 L Erlenmeyer flask dedicated platform	M1194-9907
2 L Erlenmeyer flask dedicated platform	M1194-9908
Sticky pad platform, sticky pads sold separately	M1250-9903
<b>Quick-change platform kit</b> , enables platform attachment without tools	M1192-9901
<b>Utility carrier</b> , holds racks and vessels between rubber-cushioned cross bars	M1194-9909
<b>Utility tray</b> , with non-skid rubber surface	M1194-9910
<b>Rod kit</b> , for utility carrier (one additional rod)	M1194-9923
<b>Capacity upgrade kit</b> , to convert a Model 2100 to a Model 2150	M1194-9926
<b>Temperature and speed monitoring kit</b> , for recording on an external chart recorder for Innova® 2100/2150/2300/2350	M1194-9924
<b>Drip pan</b> , for universal platform M1250-9902	M1250-9906

✎ Ordering information for other voltage options begins on page 434

## New Brunswick™ Innova® 2150



Ordering information	
Description	Order no.
<b>New Brunswick™ Innova® 2150</b> , platform sold separately, 220/230 V/50/60 Hz, orbit diameter 1.9 cm (0.75 in)	M1194-0012
<b>Interchangeable platform for Innova® 2150</b> , 61 × 45.7 cm, phenolic resin	
Universal platform	M1194-9912
1 L Erlenmeyer flask dedicated platform	M1194-9919
2 L Erlenmeyer flask dedicated platform	M1194-9920
<b>Utility carrier</b> , holds glassware between rubber-cushioned cross bars	M1194-9921
<b>Utility tray</b> , with non-skid rubber surface	M1194-9922
<b>Rod kit</b> , for utility carrier (one additional rod)	M1194-9925
<b>Quick-change platform kit</b> , enables platform attachment without tools	M1194-9927
<b>Temperature and speed monitoring kit</b> , for recording on an external chart recorder for Innova® 2100/2150/2300/2350	M1194-9924

✎ Ordering information for other voltage options begins on page 434

i For more information go to [www.eppendorf.com](http://www.eppendorf.com)

## New Brunswick™ Innova® 2300



Ordering information	
Description	Order no.
<b>New Brunswick™ Innova® 2300</b> , platform sold separately, 220/230 V/50/60 Hz, orbit diameter 2.5 cm (1 in)	M1191-0002
220/230 V/50/60 Hz, orbit diameter 5.1 cm (2 in)	M1191-0022
<b>Platform for Innova® 2300/43/43R, Excella® E10/E25/E25R</b> , 76 × 46 cm, aluminum	
Universal platform, aluminum	M1250-9920
50 mL Erlenmeyer flask dedicated platform	M1191-9908
125 mL Erlenmeyer flask dedicated platform	M1191-9909
250 mL Erlenmeyer flask dedicated platform	M1191-9910
500 mL Erlenmeyer flask dedicated platform	M1191-9911
1 L Erlenmeyer flask dedicated platform	AG-1
2 L Erlenmeyer flask dedicated platform	AG-2
2.8 L Fernbach flask dedicated platform	AG-28
6 L Erlenmeyer flask dedicated platform	AG-6
Sticky pad platform, sticky pads sold separately	M1250-9904
<b>Utility tray</b> , with non-skid rubber surface	AG-00
<b>Quick-change platform kit</b> , enables platform attachment without tools	M1191-9904
<b>Capacity upgrade kit</b> , to convert a Model 2300 to a Model 2350	M1191-9905
<b>Temperature and speed monitoring kit</b> , for recording on an external chart recorder for Innova® 2100/2150/2300/2350	M1194-9924
<b>Drip pan</b> , to catch accidental spills, for use with universal platform M1250-9920	M1250-9921

✎ Ordering information for other voltage options begins on page 434

## New Brunswick™ Innova® 2350



Ordering information	
Description	Order no.
<b>New Brunswick™ Innova® 2350</b> , platform sold separately, 220/230 V/50/60 Hz, orbit diameter 2.5 cm (1 in)	M1191-0012
220/230 V/50/60 Hz, orbit diameter 5.1 cm (2 in)	M1191-0032
<b>Interchangeable platform for Innova® 2350</b> , 91.4 × 61 cm, marine plywood unless otherwise noted	
Universal platform	PTL-386
Universal platform, aluminum	PTL-393
125 mL Erlenmeyer flask dedicated platform	M1191-9912
250 mL Erlenmeyer flask dedicated platform	M1191-9913
500 mL Erlenmeyer flask dedicated platform	M1191-9914
<b>Utility tray</b> , with non-skid rubber surface	AG-21-00
<b>Temperature and speed monitoring kit</b> , for recording on an external chart recorder for Innova® 2100/2150/2300/2350	M1194-9924

✎ Ordering information for other voltage options begins on page 434

## New Brunswick™ Innova® 5050/5051 Racking Systems



### Description

Save space and stack Innova 2300 open air shakers. Model 5050 consists of a sturdy, stainless-steel rack to hold up to 4 Innova 2300 shakers. Innova 5051 rack extension can be added to support an additional 4 shakers, bringing the total number to 8 Innova 2300 shakers.

### Product features

- > Includes electrical strip for power multiple shakers
- > Maximum speed 400 rpm for 2.5 cm (1 in) orbits and 300 rpm for 5.1 cm (2 in) orbits
- > Larger flasks can be accommodated by removing adjustable-height shelves
- > Comes pre-assembled

### Ordering information

Description	Order no.
New Brunswick™ Innova® 5050 Rack System, 230/240 V/50/60 Hz	M1232-0101
New Brunswick™ Innova® 5051 Rack Extension, 230/240 V/50/60 Hz	M1232-0111

## Clamps and Accessories for Universal Platforms



Dedicated platforms come with clamps of one size pre-installed.



Flask clamp, of one-piece stainless steel, fitted with springs for stability at elevated speeds.



Microplate racks and carriers mount to any universal platform and are used to secure microplates. Racks can either be ordered for stacking the plates or laying plates flat in a single layer.



Test tube racks, small, medium and large.



Utility carries secure vessels between adjustable, cushioned rods.



Universal platform shown with accessory clamps, test tube racks and sticky tape.

For more information go to [www.eppendorf.com](http://www.eppendorf.com)

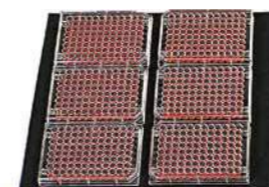

Utility trays provide a non-slip surface for low-speed applications.



Sticky pad (shown) and sticky tape replace clamps for speeds up to 250 rpm. Sticky pad requires an anodized aluminum surface.

### Accessories

Description	Order no.
<b>Test tube rack, small, 30.0 x 8.0 x 12.9 cm</b>	
diameter 8 – 11 mm, 48 tubes	M1289-0001
diameter 12 – 15 mm, 34 tubes	M1289-0002
diameter 15 – 18 mm, 24 tubes	M1289-0003
diameter 18 – 21 mm, 18 tubes	M1289-0004
diameter 22 – 26 mm, 13 tubes	M1289-0005
diameter 26 – 30 mm, 12 tubes	M1289-0006
<b>Test tube rack, medium, 36 x 8 x 12.9 cm</b>	
diameter 8 – 11 mm, 60 tubes	M1289-0010
diameter 12 – 15 mm, 44 tubes	M1289-0020
diameter 15 – 18 mm, 31 tubes	M1289-0030
diameter 18 – 21 mm, 23 tubes	M1289-0040
diameter 22 – 26 mm, 16 tubes	M1289-0050
diameter 26 – 30 mm, 16 tubes	M1289-0060
<b>Test tube rack, large, 45 x 8 x 12.9 cm</b>	
diameter 8 – 11 mm, 80 tubes	M1289-0100
diameter 12 – 15 mm, 60 tubes	M1289-0200
diameter 15 – 18 mm, 42 tubes	M1289-0300
diameter 18 – 21 mm, 30 tubes	M1289-0400
diameter 22 – 26 mm, 22 tubes	M1289-0500
diameter 26 – 30 mm, 20 tubes	M1289-0600
<b>Clamp, for 1 L media bottles</b>	ACSB-1000S
<b>Clamp, for 500 mL media bottles</b>	ACSB-500S
<b>Angled test tube rack holder, for user-supplied test tube racks and microplates</b>	TTR-210
<b>Spacer bar for TTR-210</b>	TTR-215
<b>Microplate rack, single layer, for single layer of five plates</b>	TTR-221
<b>Microplate rack, stack, stack three deepwell or nine standard plates</b>	M1289-0700
<b>Sticky pad adaptor kit, 2 anodized aluminum sheets, each 15.2 x 45.7 cm (6 x 18 in)</b>	M1250-9504
<b>Sticky tape, 500 x 4.1 cm (16.4 feet x 1.6 in) roll</b>	M1250-9600
<b>Sticky pad, 20 x 20 cm (8 x 8 in)</b>	M1250-9700
<b>Drip pan, for universal platform M1250-9902</b>	M1250-9906
<b>Drip pan, to catch accidental spills, for use with universal platform M1250-9920</b>	M1250-9921

# Universal Platforms and Clamps for Incubated Shakers

**Universal Platforms and Clamps for Incubated Shakers**

	Innova® 40/40R	Innova® 42/42R	Innova® 43/43R	Innova® 44/44R
	M1250-9902	M1250-9902	M1250-9920	M1282-9904
10 mL Erlenmeyer flasks	109	109	183	187
25 mL Erlenmeyer flasks	64	64	92	93
50 mL Erlenmeyer flasks	45	45	92	91
125 mL Erlenmeyer flasks	21	21	39	39
250 mL Erlenmeyer flasks	18	18	30	30
500 mL Erlenmeyer flasks	14	14	18	24
1 L Erlenmeyer flasks	8	8	12	14
2 L Erlenmeyer flasks	5	5	8	8
500 mL media bottle flask	9	9	19	18
1 L media bottle flask	8	8	13	13
2 L Lauber Thompson	5	5	8	8
2.8 L Fernbach flasks	4	4	6	6
3 L Erlenmeyer flasks	4	4	6	6
4 L Erlenmeyer flasks		4	6	6
5 L Erlenmeyer flasks		4	6	6
6 L Erlenmeyer flasks		2	4	
Microplate rack, single layer	5	2	4	4
Microplate rack, stack	8	8	16	16
Test tube rack, small, 30 x 8 x 12.9 cm	5	5	9	9
Test tube rack, medium, 36 x 8 x 12.9 cm	5	5	9	9
Test tube rack, large, 45 x 8 x 12.9 cm	4	4	7	7
Platform size	46 x 46 cm (18 x 18 in)	46 x 46 cm (18 x 18 in)	76 x 46 cm (30 x 18 in)	76 x 46 cm (30 x 18 in)

Innova® S44i	Excella® E24/E24R	Excella® E25/E25R	Clamp	Clamp
M1250-9920	M1250-9902	M1250-9920	Order no.	Dimensions (W x H)
238	109	183	ACE-10S	31 x 26 mm
238	64	92	M1190-9004	38 x 21 mm
130	45	92	M1190-9000	51 x 26 mm
81	21	39	M1190-9001	66 x 36 mm
49	18	30	M1190-9002	79 x 48 mm
36	14	18	M1190-9003	100 x 52 mm
20	8	12	ACE-1000S	120 x 63 mm
13	5	8	ACE-2000S	152 x 71 mm
20	9	19	ACSB-500S	110 x 108 mm
20	8	13	ACSB-1000S	129 x 146 mm
13	5	8	M1190-9005	168 x 112 mm
8	4	6	ACFE-2800S	198 x 66 mm
8	4	6	ACE-3000S	189 x 128 mm
8		6	ACE-4000S	196 x 95 mm
6		6	ACE-5000S	222 x 145 mm
4		4	ACE-6000S	225 x 96 mm
4	5	4	TTR-221	
20	8	16	M1289-0700	
12	5	9	see page 326	
10	5	9	see page 326	
8	4	7	see page 326	
76 x 62 cm (30 x 24 in)	46 x 46 cm (18 x 18 in)	76 x 46 cm (30 x 18 in)		

**Dedicated Platforms and Clamps for Incubated Shakers**

	Innova® 40/40R		Innova® 42/42R		Innova® 43/43R	
	Clamps	Order no.	Clamps	Order no.	Clamps	Order no.
50 mL Erlenmeyer flasks	64	M1194-9903	64	M1194-9903	108	M1191-9908
125 mL Erlenmeyer flasks	34	M1194-9904	34	M1194-9904	60	M1191-9909
250 mL Erlenmeyer flasks	25	M1194-9905	25	M1194-9905	40	M1191-9910
500 mL Erlenmeyer flasks	16	M1194-9906	16	M1194-9906	24	M1191-9911
1 L Erlenmeyer flasks	9	M1194-9907	9	M1194-9907	15	AG-1
2 L Erlenmeyer flasks	5	M1194-9908	5	M1194-9908	12	AG-2
2.8 L Fernbach flasks	4	M1233-9932	4	M1233-9932	6	AG-28
4 L Erlenmeyer flasks			4	M1233-9930	6	AG-4
6 L Erlenmeyer flasks					4	AG-6
Sticky platform		M1250-9903		M1250-9903		M1250-9904
Platform size	46 x 46 cm (18 x 18 in)		46 x 46 cm (18 x 18 in)		76 x 46 cm (30 x 18 in)	

Innova® 44/44R		Innova® S44i		Excella® E24/E24R		Excella® E25/E25R	
Clamps	Order no.	Clamps	Order no.	Clamps	Order no.	Clamps	Order no.
60	M1282-9905	86	S44I040002	64	M1194-9903	108	M1191-9908
40	M1282-9906	53	S44I040003	34	M1194-9904	60	M1191-9909
24	M1282-9907	39	S44I040004	25	M1194-9905	40	M1191-9910
15	M1282-9908	23	S44I040005	16	M1194-9906	24	M1191-9911
12	M1282-9909	15	S44I040006	9	M1194-9907	15	AG-1
6	M1282-9910	8	S44I040007	5	M1194-9908	12	AG-2
6	M1282-9911	8	S44I040008	4	M1233-9932	6	AG-28
						6	AG-4
						4	AG-6
	M1282-9913				M1250-9903		M1250-9904
76 x 46 cm (30 x 18 in)		76 x 62 cm (30 x 24 in)		46 x 46 cm (18 x 18 in)		76 x 46 cm (30 x 18 in)	

For more information go to [www.eppendorf.com](http://www.eppendorf.com)

# Universal Platforms and Clamps for Innova® Open Air Shakers

**Universal Platforms and Clamps for Innova® Open Air Shakers**

	Innova® 2000	Innova® 2050	Innova® 2100	Innova® 2150
	M1001-0240	M1190-9900	M1250-9902	M1194-9912
10 mL Erlenmeyer flasks	60	86	109	
25 mL Erlenmeyer flasks	20	32	64	
50 mL Erlenmeyer flasks	15	32	45	63
125 mL Erlenmeyer flasks	11	16	21	35
250 mL Erlenmeyer flasks	6	10	18	24
500 mL Erlenmeyer flasks	4	8	14	20
1 L Erlenmeyer flasks			8	12
2 L Erlenmeyer flasks			5	6
500 mL media bottle flask	4	6	9	15
1 L media bottle flask	2	4	8	11
2 L Lauber Thompson			4	5
2.8 L Fernbach flasks			4	5
3 L Erlenmeyer flasks			4	5
4 L Erlenmeyer flasks			4	5
5 L Erlenmeyer flasks			4	4
6 L Erlenmeyer flasks			2	3
Microplate rack, stack	3	8	8	16
Microplate rack, single layer		2	2	4
Test tube rack, small, 30 x 8 x 12.9 cm	3	4	5	9
Test tube rack, medium, 36 x 8 x 12.9 cm		3	5	9
Test tube rack, large, 45 x 8 x 12.9 cm			4	7
Platform size	33 x 28 cm (13 x 11 in)	41 x 31 cm (16 x 12 in)	46 x 46 cm (18 x 18 in)	61 x 46 cm (24 x 18 in)

Innova® 2300	Innova® 2350	Clamp	Clamp
M1250-9920	PTL-386	Order no.	Dimensions (W x H)
183		ACE-10S	31 x 26 mm
92		M1190-9004	38 x 21 mm
92		M1190-9000	51 x 26 mm
39	75	M1190-9001	66 x 36 mm
30	50	M1190-9002	79 x 48 mm
18	30	M1190-9003	100 x 52 mm
12	24	ACE-1000S	120 x 63 mm
8	15	ACE-2000S	152 x 71 mm
19	35	ACSB-500S	110 x 108 mm
13	23	ACSB-1000S	129 x 146 mm
6	12	M1190-9005	168 x 112 mm
6	12	ACFE-2800S	198 x 66 mm
6	11	ACE-3000S	189 x 128 mm
6	11	ACE-4000S	196 x 95 mm
6	8	ACE-5000S	222 x 145 mm
4	7	ACE-6000S	225 x 96 mm
16	16	M1289-0700	
4	4	TTR-221	
9	18	see page 326	
9	13	see page 326	
7	12	see page 326	
76 x 46 cm (30 x 18 in)	91 x 61 cm (36 x 24 in)		

**Dedicated Platforms and Clamps for Innova Open Air Shakers**

	Innova® 2000		Innova® 2050		Innova® 2100	
	Clamps	Order no.	Clamps	Order no.	Clamps	Order no.
10 mL Erlenmeyer flasks	60	AG2-10	86	M1190-9901		
25 mL Erlenmeyer flasks	32	M1190-9919	48	M1190-9902		
50 mL Erlenmeyer flasks	20	M1190-9915	35	M1190-9903	64	M1194-9903
125 mL Erlenmeyer flasks	12	M1190-9916	20	M1190-9904	34	M1194-9904
250 mL Erlenmeyer flasks	8	M1190-9917	12	M1190-9905	25	M1194-9905
500 mL Erlenmeyer flasks	6	M1190-9918	8	M1190-9906	16	M1194-9906
1 L Erlenmeyer flasks			6	M1190-9911	9	M1194-9907
2 L Erlenmeyer flasks					5	M1194-9908
2.8 L Fernbach flasks						M1233-9932
4 L Erlenmeyer flasks						
6 L Erlenmeyer flasks						
Sticky platform		M1190-0300				M1250-9903
Platform size	33 x 28 cm (13 x 11 in)		41 x 31 cm (16 x 12 in)		46 x 46 cm (18 x 18 in)	

Innova® 2150		Innova® 2300		Innova® 2350	
Clamps	Order no.	Clamps	Order no.	Clamps	Order no.
80	M1194-9915	108	M1191-9908		
48	M1194-9916	60	M1191-9909	96	M1191-9912
35	M1194-9917	40	M1191-9910	70	M1191-9913
20	M1194-9918	24	M1191-9911	40	M1191-9914
12	M1194-9919	15	AG-1		
8	M1194-9920	12	AG-2		
		6	AG-28		
		6	AG-4		
		4	AG-6		
			M1250-9904		
61 x 46 cm (24 x 18 in)		76 x 46 cm (30 x 18 in)		91 x 61 cm (36 x 24 in)	

For more information go to [www.eppendorf.com](http://www.eppendorf.com)

## Your Global Supplier for Products and Solutions



### OEM Products

- > Innovative Technology
- > Cutting-Edge Development
- > Highest Quality Standard
- > Eppendorf manufactured



[www.eppendorf.com/oem-video](http://www.eppendorf.com/oem-video)

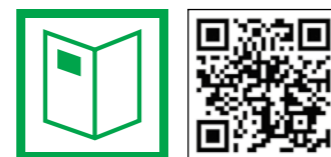

[www.eppendorf.com/oem-brochure](http://www.eppendorf.com/oem-brochure)

### Description

Customized Solutions products are Eppendorf products that have been tailored to the individual requirements of major customers.

The Customized Eppendorf Automation Tips can be found offering solutions to requirements, such as:

- > Conductive
- > Non-conductive
- > Special tray colors
- > Dimensions
- > Materials
- > Packaging
- > Alternative labeling

For increased convenience printing your company name and identification of products on plates can be easily carried out.

Our OEM portfolio offers further options such as:  
Special purity degree: "customized clean".

**The flexibility of Eppendorf OEM/Customized Solutions options are designed to fit your highest demands. Examples of customized items:**

- > Modified packaging
- > Customized designs or logos

For more information go to [www.eppendorf.com/OEM](http://www.eppendorf.com/OEM)

OEM-components/products are sold exclusively to companies who sell these goods on to third parties in conjunction with their own products or as a component of their kits. Technical specifications subject to change.

## Customized Liquid Handling Robots and Cyclers

We offer OEM PCR cyclers for a range of applications including diagnostic use:

- > Silver or aluminum block
- > With or without gradient function
- > Flexlid for a wide range of consumables

Customization according to your needs is our business!



[www.eppendorf.com/oem](http://www.eppendorf.com/oem)



### Description

A selection of Eppendorf instruments for OEM opportunities is the epMotion®, Eppendorf's own developed and manufactured Liquid Handling Workstation.

The range of Eppendorf automated workstations provides an open OEM platform for many Liquid Handling applications by:

- > Flexibility of positions
- > Technology of magnetic separation
- > GxP software

OEM-components/products are sold exclusively to companies who sell these goods on to third parties in conjunction with their own products or as a component of their kits. Technical specifications subject to change.



# »Heal, Fuel, and Feed the World.«

*Stephen Sherwin*

Bioprocess engineers develop and produce a multitude of products and ingredients available today. Their applications are diverse, and the products can be found in pharmaceutical, chemical, and nutrition industries. Stephen Sherwin, former chairman of BIO association put it aptly: "Heal, fuel, and feed the world".

Our Eppendorf bioprocess solutions are successfully used in these industries and in applied research for decades. By exploiting the strong synergies in bioreactor technology and polymer manufacturing, Eppendorf has emerged as a global player and valuable resource to its customers. With an integrated portfolio comprising software, instruments, consumables, and services, we can satisfy the demands of bioprocess development through production. In that way and in line with our corporate mission, we contribute to the efforts of Eppendorf customers worldwide to improve human living conditions.

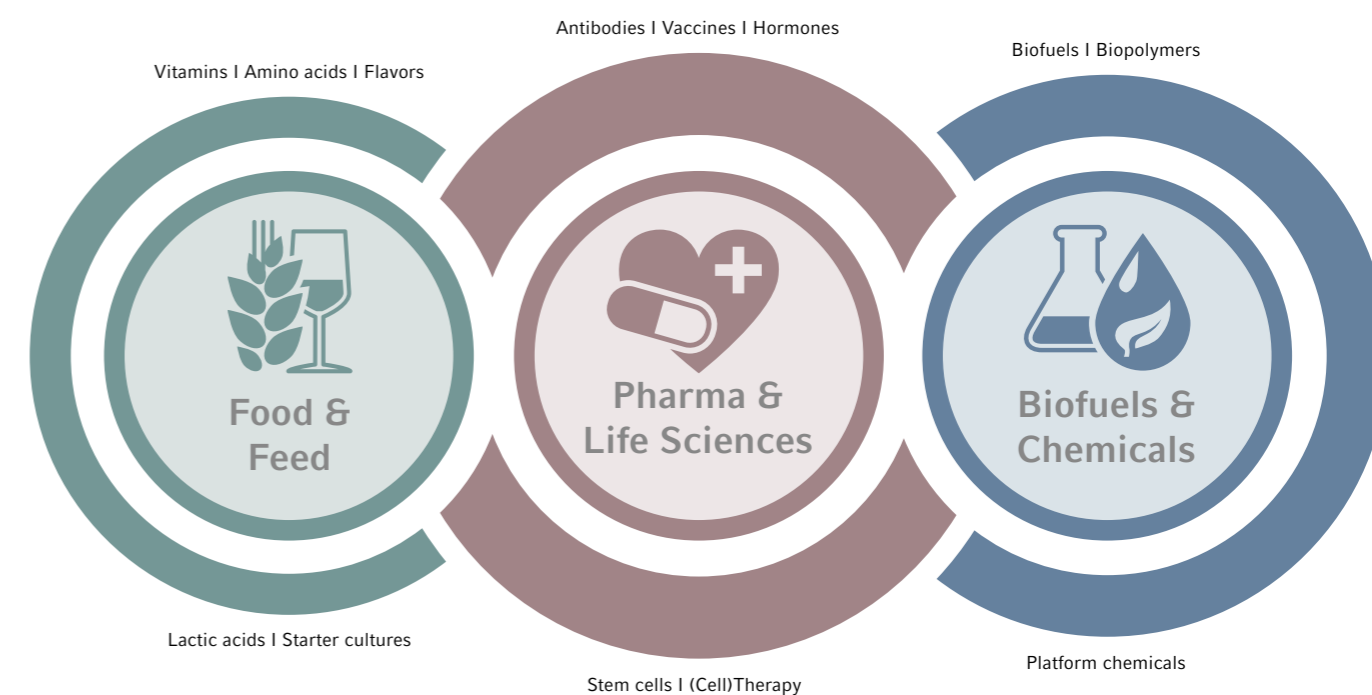



# Addressing Our Customers' Challenges

Single-use equipment, automation, perfusion culture, and other techniques have the potential to increase efficiency and change the way scientists and engineers work. Along with process intensification comes the need to utilize resources wisely. Users have to cope with rising amounts of data in order to achieve their goals faster. They are being

appraised by process performance characteristics such as costs per run and turn-around times. Eppendorf is the right partner to meet these challenges. Satisfying professionals with full solutions to their tasks is what our bioprocess specialists are focussing on day-to-day. Expert teams take care of our customers worldwide.

»Our bioprocess customers expect a special kind of support. Not only do our employees need to know their way around the technical devices; a knowledge of biological applications is also required. After all, we can only help if we understand exactly what our customers do and need. And in many cases, this close contact also results in new solutions.«

Dr. Karl Rix, Vice President Marketing, Portfolio and Support – Bioprocess, Eppendorf



## Process and Manufacturing

The biopharmaceutical landscape has long been dominated by the production of recombinant proteins and monoclonal antibodies (mABs). Nowadays, the industry is moving towards more diverse pipelines with a broader variety of biological active pharmaceutical ingredients (APIs), including biosimilars. Reacting to these rising demands, companies put flexible systems in place, optimized to balance costs and time-to-market.

Eppendorf offers flexible bioprocess solutions from a single source, supporting batch, fed-batch, continuous, and perfusion cultivation. From parallel small-scale bioreactor systems for early stage bioprocess development, benchtop bioreactors and fermentors for the laboratory scale to sterilize-in-place products for technology transfer and scale-up to production. They enable bioprocess professionals to establish robust and reproducible processes in all scales.



## Control and Analytics

Monitoring and control is key in bioprocess development and ensures the process environment for optimum cell growth and high-titer production. Applying Process Analytical Technology (PAT) concepts provides real-time insights improving product quality. Predictive models of cell and process performance enhance process understanding and optimize control through forecasting and estimating optimum parameter settings. Statistical tools like Multivariate Data Analysis (MVA) help scientists to get the most out of their data.

Software solutions from Eppendorf make use of these techniques by providing more than just bioprocess control. Comprehensive data- and information management supports scientists in enhancing their development efforts.



## Quality and Regulatory Aspects

The FDA's Quality by Design approach aims to design product quality and process efficiency into the process as early as possible. It includes the identification of critical process parameters (CPPs) and critical quality attributes (CQAs). These have to be monitored, controlled, and documented already early in biopharmaceutical development. Process automation opens up new possibilities in terms of quality control and validation, especially in GMP environments.

Eppendorf's parallel small-scale bioreactor systems support customers in implementing QbD principles in the development phase. Our advanced bioprocess control software is 21 CFR Part 11 compatible. Single-use bioreactor solutions from Eppendorf help make laboratories more efficient and safe.



## Integration and Services

Bioprocess equipment requires first-class service to achieve optimum results. Globalization, digital technologies, rising cost pressures, and the urge to be flexible in their operations make companies in the bioprocessing space face new challenges. They have to adapt their processes, facilities, and supply chains to these needs, establish global networks, and ensure high-quality training of all employees.

At Eppendorf, we offer broad expertise in automation and integration of third-party devices, making sure your systems run efficiently and are seamlessly integrated. Eppendorf customers can rely on high-quality technical and application support as well as comprehensive training and technical documentation.

# Cell Handling



Model	DASbox® Mini Bioreactor System	Small Scale Parallel Bioreactor Systems
Page(s)	342	342
Working volume range <sup>1)</sup>	60 – 250 mL	0.2 – 3.8 L
Single-use vessels available	■	■
Glass vessels, autoclavable	■	■
Stainless-steel vessels, SIP		
Interchangeable vessels	■	■
Bacteria/yeasts/fungi	■	■
Plant cells/algae	■	■
Mammalian/animal cells	■	■
Stem cells	■	■
Insect cells	■	■
Number of parallel units	Up to 24	Up to 16
Controller <sup>2)</sup>	DWC	DWC
Touchscreen controller		
BioCommand®		
DASware®	■	■
Gas mixing options	4 gas (air, N <sub>2</sub> , O <sub>2</sub> , CO <sub>2</sub> )	4 gas (air, N <sub>2</sub> , O <sub>2</sub> , CO <sub>2</sub> )
Gas flow control <sup>3)</sup>	TMFC	R or TMFC
Exhaust analysis	■	■
Optical density measurement	■	■
Validation		

<sup>1)</sup> Realized using multiple vessel sizes <sup>2)</sup> Controllers: DWC = DASware control, RPC = Reactor Process Controller, BCS = BioFlo Control Software, PLC = Programmable Logic Controller

<sup>3)</sup> Gas Flow Controllers: R = Rotameter, TMFC = Thermal Mass Flow Controller <sup>4)</sup> Rotameter is for overlay only



Model	BioFlo® 120	BioFlo 320
Page(s)	344	344
Working volume range	0.25 – 40 L	0.25 – 40 L
Single-use vessels available	■	■
Glass vessels, autoclavable	■	■
Stainless-steel vessels, SIP		
Interchangeable vessels	■	■
Bacteria/yeasts/fungi	■	■
Plant cells/algae	■	■
Mammalian/animal cells	■	■
Stem cells	■	■
Insect cells	■	■
Number of parallel units		up to 8
Controller <sup>2)</sup>	BCS	BCS
Touchscreen controller	■	■
BioCommand®	■	■
DASware®	■	■
Gas mixing options	4 gas (air, N <sub>2</sub> , O <sub>2</sub> , CO <sub>2</sub> )	4 gas (air, N <sub>2</sub> , O <sub>2</sub> , CO <sub>2</sub> )
Gas flow control <sup>3)</sup>	R or TMFC	TMFC
Exhaust analysis	■	■
Optical density measurement	■	■
Validation		

<sup>1)</sup> Realized using multiple vessel sizes <sup>2)</sup> Controllers: DWC = DASware control, RPC = Reactor Process Controller, BCS = BioFlo Control Software, PLC = Programmable Logic Controller

<sup>3)</sup> Gas Flow Controllers: R = Rotameter, TMFC = Thermal Mass Flow Controller <sup>4)</sup> Rotameter is for overlay only



Are you searching for more bioprocess products? Have a look at our 2018 bioprocess catalog - available online!

More information at  
[www.eppendorf.com/catalog](http://www.eppendorf.com/catalog),  
 in the Eppendorf App, and in the eShop.



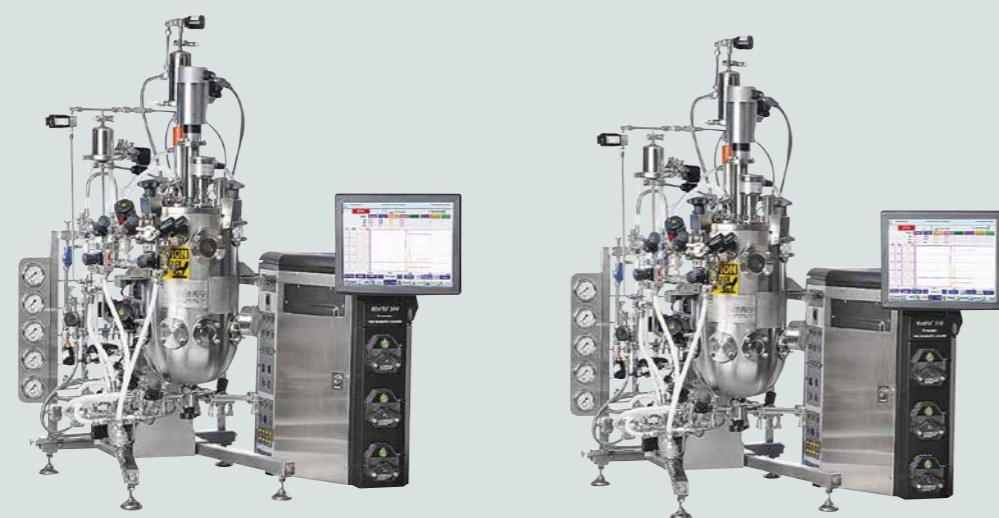

Model	BioFlo 510	CelliGen 510
Page(s)	346	346
Working volume ranges <sup>1)</sup>	10.75 – 32 L	10.75 – 32 L
Single-use vessels available		
Glass vessels, autoclavable		
Stainless-steel vessels, SIP	■	■
Interchangeable vessels		
Bacteria/yeasts/fungi	■	
Plant cells/algae	■	■
Mammalian/animal cells		■
Stem cells		■
Insect cells	■	■
Number of parallel units		
Controller <sup>2)</sup>	RPC/PLC	RPC/PLC
Touchscreen controller	■	■
BioCommand®	■	■
DASware®		
Gas mixing options	4-gas (air, N <sub>2</sub> , O <sub>2</sub> , CO <sub>2</sub> )	4-gas (air, N <sub>2</sub> , O <sub>2</sub> , CO <sub>2</sub> )
Gas flow control <sup>3)</sup>	R or TMFC	R or TMFC
Exhaust analysis	■	■
Optical density measurement		
Validation	■	■

<sup>1)</sup> Realized using multiple vessel sizes <sup>2)</sup> Controllers: DWC = DASware control, RPC = Reactor Process Controller, BCS = BioFlo Control Software, PLC = Programmable Logic Controller <sup>3)</sup> Gas Flow Controllers: R = Rotameter, TMFC = Thermal Mass Flow Controller



Model	BioFlo 610	BioFlo Pro
Page(s)	346	346
Working volume ranges <sup>1)</sup>	13 – 100 L	45 – 1.200 L
Single-use vessels available		
Glass vessels, autoclavable		
Stainless-steel vessels, SIP	■	■
Interchangeable vessels		
Bacteria/yeasts/fungi	■	■
Plant cells/algae	■	■
Mammalian/animal cells		
Stem cells		
Insect cells	■	■
Number of parallel units		
Controller <sup>2)</sup>	RPC	PLC
Touchscreen controller	■	■
BioCommand®	■	■
DASware®		
Gas mixing options	2-gas (air, O <sub>2</sub> )	2-gas (air, O <sub>2</sub> )
Gas flow control <sup>3)</sup>	R or TMFC	R or TMFC
Exhaust analysis	■	■
Optical density measurement		
Validation	■	■

<sup>1)</sup> Realized using multiple vessel sizes <sup>2)</sup> Controllers: DWC = DASware control, RPC = Reactor Process Controller, BCS = BioFlo Control Software, PLC = Programmable Logic Controller <sup>3)</sup> Gas Flow Controllers: R = Rotameter, TMFC = Thermal Mass Flow Controller

## Parallel Bioprocessing for Unparalleled Results – Small-Scale Systems



[www.eppendorf.com/dasbox-video](http://www.eppendorf.com/dasbox-video)

### DASbox Mini Bioreactor System 60 – 250 mL working volume

#### Product features

- > 4-fold parallel system extendable to up to 24 parallel operated glass or single-use bioreactors
- > Suitable for cell culture and microbial fermentation
- > Compact mini bioreactor system: requires only 7 cm (3 inches) bench space per bioreactor
- > Optimal tool for DoE and scale down approaches
- > Agitation control supporting overhead-driven Rushton, marine-type or pitched blade impellers
- > Innovative liquid-free temperature control system needs no coolant agent supply and supports independent temperature control for each bioreactor
- > Accurate monitoring and control of pH, DO and level
- > Variable speed pumps for accurate liquid addition and operation in batch, fed-batch, continuous and cyclic perfusion mode
- > 4 mass flow controllers per bioreactor allow for individual mixing of air, N<sub>2</sub>, O<sub>2</sub> and CO<sub>2</sub> to headspace and/or submerged
- > Novel liquid-free Peltier exhaust condenser with easy to handle slide in – slide out activation and deactivation
- > DASware control Software for advanced process control
- > Compatible with DASware Software Suite for interconnectivity and bioprocess information management



### DASGIP Parallel Bioreactor Systems 0.2 – 3.8 L working volume

#### Product features

- > Parallel operation of up to 16 glass or single-use bioreactors
- > DASGIP Bioblock for advanced and user-friendly temperature control or temperature control via heat blankets and cooling fingers (benchtop bioreactors)
- > Suitable for cell culture, microbial fermentation and phototrophic cultivation
- > Modular design of control units allows for flexible system configurations that meet the demands of specific applications
- > Control of agitation, pH, level and DO (including customizable cascade modes) in each bioreactor
- > Variable speed pumps for accurate liquid addition and operation in batch, fed-batch, continuous and cyclic perfusion mode
- > Optical absorbance measurement for online calculation of e.g. OD<sub>600</sub> or cell dry weight
- > TMFC individual gas mixing of air, N<sub>2</sub>, O<sub>2</sub> and CO<sub>2</sub>
- > Online calculation of OTR, CTR and RQ
- > DASware control Software for advanced process control
- > Compatible with DASware Software Suite for interconnectivity and bioprocess information management



## Exceedingly Versatile – Bench Scale Fermentors and Bioreactors



**BioFlo 120**  
0.4 – 10.5 L working volume (autoclavable),  
0.25 – 40 L working volume (single-use)

### Product features

- > Updated flexible software platform for universal control of both microbial and cell culture applications
- > Easy-to-use, automated control for critical process parameters
- > Compatible with BioBLU Single-Use Vessels for fermentation and cell culture applications
- > Precise temperature control provided through interchangeable heat-blanketed or water-jacketed vessels
- > High precision thermal mass flow controller (TMFC) for automatic gas flow control
- > Automatic gas mix for four independent sparge gas supplies
- > Available analog input/output connection for direct integration of accessories (i.e. scales, variable-speed pumps, etc...)
- > Integrated 7 in touchscreen for local process control
- > Compatible with DASware Software Suite or BioCommand for bioprocess information management



[www.eppendorf.com/BioFlo120](http://www.eppendorf.com/BioFlo120)



[www.eppendorf.com/bioflo320-360](http://www.eppendorf.com/bioflo320-360)

**BioFlo 320**  
0.6 – 10.5 L working volume (autoclavable),  
0.25 – 40 L working volume (single-use)

### Product features

- > Interchangeable autoclavable and BioBLU Single-Use Vessels
- > Integrated Mettler Toledo® Intelligent Sensor Management (ISM) platform
- > Control up to eight systems from a single user interface
- > Universal control for both microbial and cell culture applications
- > Field-upgradable TMFC drawers for sparge and overlay gas
- > Enhanced software package with new cascade and time profile features
- > Built-in optical pH sensing technology for use with the BioBLU Single-Use Vessels
- > Ethernet communication for multi-unit control, Eppendorf SCADA software, and IP addressing
- > Up to six integrated pumps capable of operating in variable-speed mode
- > Eight independently controlled process gas supplies
- > Suitable for batch, fed-batch, and continuous processes
- > Validation packages available for GMP-regulated processes
- > Compatible with DASware Software Suite or BioCommand for bioprocess information management



Eppendorf offers a diverse range of standard impellers such as:

1. Pitched blade impeller
  2. Marine impeller
- Rushton and Rushton-type impellers (not shown)



Eppendorf also offers special impellers which can facilitate continuous and perfusion processes:

3. Spin filter (shown with marine impeller)
4. Cell-lift impeller
5. Packed-bed basket impeller with draft tube for use with Fibra-Cel® disks (complete impeller assembly shown below)



**Impellers and Fibra-Cel disk options  
enhance growth and productivity**

Fibra-Cel disks are a solid support material used with packed-bed bioreactors for growth of adherent mammalian, animal and insect cells, when secreted proteins are desired. Key advantages:

- > Cell densities averaging 10 times higher than traditional microcarriers, due to protection from shear forces
- > Higher mass transfer of nutrients and oxygen
- > Low pressure drop across the bed for efficient scale-up
- > Higher surface-to-volume ratios



[www.eppendorf.com/bioprocess-spin-filter](http://www.eppendorf.com/bioprocess-spin-filter)

## Industry Standards Meet Flexibility – Sterilizable-in-Place Fermentors and Bioreactors



**BioFlo 510 and CelliGen 510**  
Bench- and pilot-scale SIP fermentor and bioreactor  
10.75 – 32 L working volume

### Product features

- > SIP bench and pilot scale reactors designed to meet the needs of R and D through production
- > Modular design allows for complete system flexibility
- > Add or remove components pre- or post-delivery
- > Multiple impeller and gas flow options
- > Features intuitive RPC control software and touchscreen interface
- > Optional Allen Bradley® PLC
- > Integrated load cell for online vessel volume monitoring
- > Fully automated SIP sequence for sterilization
- > Validation packages available
- > 7 additional analog input/output connections for local integration of ancillary equipment
- > ASME-rated pressure vessel



**BioFlo 610**  
Pilot-scale SIP fermentor  
13 – 100 L working volume

### Product features

- > Integrated mobile skid simplifies transport
- > Pilot production system without the traditional cost or footprint
- > Modular design allows for complete system flexibility
- > Features intuitive RPC control software and touchscreen interface
- > Fully integrated load cell for online vessel volume monitoring
- > Validation packages available
- > 7 additional analog input/output connections for local integration of ancillary equipment
- > ASME-rated pressure vessel



**BioFlo Pro**  
Large-scale SIP fermentor  
45 – 1,200 L working volume

### Product features

- > Large-scale industrial system supporting operation in accordance to cGMP and GAMP® guidelines
- > Modular design with over a hundred options allows for high level of customization pre and post delivery
- > Multiple validation package offerings
- > Open piping skid allows for easy accessibility
- > NEMA-4 (IP65) rated control cabinet with industry-standard Allen Bradley PLC
- > Flush mounted vessel ports for enhanced vessel design and drainability
- > Multiple impeller and gas flow options
- > Optional validation packages available
- > ASME-rated pressure vessel



# BioBLU® Single-Use Vessels – Dependability through Proven Design

## Single-use simplicity

With renowned polymer expertise, Eppendorf is proud to offer the largest portfolio of rigid walled stirred-tank single-use vessels – in small and bench scale, to be operated with parallel DASbox Mini Bioreactor System, DASGIP Parallel Bioreactor Systems or BioFlo bench scale systems.



From 65 mL to 40 L, working volume, Eppendorf has a single-use solution to meet your needs

## Product features

- > Proven performance and scalability of stirred-tank design
- > User-friendly set-up for rapid turnaround, shorter development times and lower operating costs
- > Specifically adapted designs available for microbial applications
- > Packed-bed configuration with Fibra-Cel disks is ideal for perfusion/continuous processes
- > USP Class VI and animal component-free materials, making vessels appropriate for GMP production
- > Non-invasive or industry standard sensor technology



[www.eppendorf.com/bioblu](http://www.eppendorf.com/bioblu)

## BioBLU c Single-Use Vessels for cell culture applications

Single-use solutions for small and bench scale cell culture applications. A full portfolio of vessels covers a working volume range of 100 mL – 40 L, offering unmatched scalability. The single-layer polymer design mitigates issues related to leachables and extractables.



## BioBLU 5p Single-Use Vessel with packed bed

For the cultivation of adherent cells and for perfusion processes we offer the BioBLU 5p packed-bed vessel. It utilizes the proprietary Eppendorf packed-bed impeller design and is pre-loaded with Fibra-Cel disks. Providing a shear-free environment, it is a premium choice in a wide variety of applications, including the production of secreted products and stem cell culture.



## BioBLU f Single-Use Vessels for microbial applications

Single-use solutions for small and bench scale fermentation applications, covering a working volume range of 65 mL – 3.75 L. Compared to cell culture applications, fermentation processes have much higher mass transfer and heat removal requirements. Proven stirred-tank design, powerful overhead drives featuring Rushton-type impellers, and innovative baffles for cooling make it possible for the BioBLU f vessels to achieve these demands, and make them a premium solution for microbiology.



## BioBLU Single-Use Vessel Adaptor Kits

BioBLU vessels are designed for use with the Eppendorf DASbox and DASGIP systems, BioFlo 120, and BioFlo 320. A range of adaptor kits is offered as well, enabling your existing bioreactor system for single-use operation without the expense of replacing the whole system. BioBLU Single-Use Vessel bundles provide you with highest flexibility. They ease up to switch your bioreactor system from single-use to reusable vessel usage, back and forth.



# Eppendorf Bioprocess Software – Much More Than Just Bioprocess Control

Eppendorf offers BioCommand and DASware control Supervisory Control and Data Acquisition (SCADA) software packages for advanced bioprocess control. Next-generation bioprocess management is provided by the comprehensive DASware software suite.



Eppendorf bioprocess software solutions – advanced monitoring and control through comprehensive information management

### BioCommand software

Enhances your ability to monitor, control and log data from your fermentation and cell culture processes through your personal computer. Three distinct packages provide the tools needed for research, optimization, and if needed, the security and audit trails to support your regulatory requirements.

- > **Track and Trend:** Provides the ability to trend and control parameter setpoints, establish alarm settings, and produce batch records; and is ideal for basic process management
- > **Batch Control:** Additional enhanced control features including a sophisticated programming module, custom synoptic display window, and equipment lock-out feature
- > **Batch Control Plus:** Includes three levels of security, event logs, and audit-trail capabilities to be compatible with the FDA 21 CFR Part 11

Features	Track and Trend	Batch Control	Batch Control Plus	DASware control
Batch info	■	■	■	■
User-defined event log	■	■	■	■
Summary	■	■	■	■
Loop info	■	■	■	■
Alarms	■	■	■	■
Trend graphs	■	■	■	■
Data log	■	■	■	■
Reports	■	■	■	■
Graphical programming	■	■	■	■
Script programming	■	■	■	■
Synoptic display	■	■	■	■
Equipment lock-out	■	■	■	■
Audit trail/security	■	■	■	■
21 CFR Part 11	■	■	■	■ <sup>1)</sup>
OPC compliance	■	■	■	■
Parallel calibration	■	■	■	■
DASware compatibility	■	■	■	■

<sup>1)</sup> 21 CFR Part 11 compatibility is available for DASware control as an optional package. Please contact us for further information.

### DASware control software

Is at the core of all DASbox and DASGIP systems and was designed for parallel cultivation with individual control of each bioreactor. Parallel calibration and cleaning procedures are supported as well as integrated batch functionality for process and recipe management. It features easy one-click start, configurable online charts, trending, logging rates and online configurable control parameters and profiles. Full controller scripting eases scale-up and scale-down. Automated data export, reporting and chart creation with Microsoft® Excel® add-in as well as professional database with managed access (Microsoft® SQL Server®) support advanced reporting and data processing. DASware analyze and DASware connect enable OPC client/server functionality.



[www.eppendorf.com/appnote301](http://www.eppendorf.com/appnote301)



[www.eppendorf.com/biocommand-video](http://www.eppendorf.com/biocommand-video)

### DASware software suite

Next-generation bioprocess management  
A suite of smart and flexible software solutions to accelerate bioprocess development. It enables interconnectivity of bioreactors with external lab-devices, comprehensive data- and information management, Design of Experiments (DoE) and remote control of bioprocesses. DASware can be used with any Eppendorf benchtop bioreactor solution.



#### DASware access

- > Remote monitoring and control of bioprocesses via PC, Notebook and Netbook or with the DASGIP iApp via iPhone®, iPod touch® and iPad®



#### DASware design

- > Applies the Design of Experiments (DoE) concept via a full factorial DoE builder or by importing DoE designs from third-party DoE tools



#### DASware analyze

- > Seamless integration of external lab devices to the bioreactor allows for process automation and feedback control loops



#### DASware discover

- > A comprehensive and user-friendly information management solution for bioprocessing



#### DASware connect

- > Integration into process control systems and legacy corporate historians facilitating company-wide access to all relevant bioprocess data



**epServices**  
for premium performance



Application Support



Seminars  
and Trainings



Technical Service  
and Support



Maintenance  
and Certification

**epServices**

Eppendorf is known as a market leader in providing outstanding quality and consistently reliable instruments and consumables. Above all, we are committed to providing sincere, reliable services and tools to help you maintain premium performance, and maximum safety of our instruments and your applications. These services are performed by our dedicated Application, Training, and Technical Service teams worldwide.

[www.eppendorf.com/epServices](http://www.eppendorf.com/epServices)

Technical specifications subject to change.

# For Premium Performance

Premium services for your laboratory instruments

## Preventive Maintenance

Preventive maintenance is a schedule of planned service measures aimed at the prevention of unexpected downtimes and failures through routine maintenance and early detection of problems. Eppendorf offers service programs to meet your individual needs, and to keep your instruments in perfect working order.

## ESSENTIAL CHECK

Check of all fundamental functions of the product

## ADVANCED MAINTENANCE

Preventive maintenance service to meet manufacturer specifications

## PREMIUM SERVICE

Complete maintenance and repair service agreement solution for your peace of mind



## Calibration and Verification

Regular calibration and verification services ensure the precision and accuracy of your instrument and pipetting tool is maintained, and that your results are consistent and reliable. We offer a range of service options from quick calibration to custom designed calibration services (i.e. GLP). The resulting certificates support the documentation for your Quality Management System. We also provide pipette calibration services according to ISO 17025 in our major markets.

## IQ/OQ Services

Installation Qualification & Operational Qualification services assure that instrumentation is installed and running according to manufacturer specifications. IQ/OQ documentation is supplied to help you prepare for your quality and regulatory audits.



## Certification Support

Certification Support is designed to safeguard your results and to ensure compliance with your laboratory guidelines with the necessary certification documents.

All certificates and Material Safety Data Sheets (MSDS) are provided for download on [www.eppendorf.com/epServices](http://www.eppendorf.com/epServices)



## Application Support

Are you having trouble with a protocol or are not sure how to use a piece of Eppendorf equipment? We are happy to advise and assist you via phone or our website e-mail contact form at our worldwide Eppendorf Support Centers.

## Eppendorf Training Center



### Become a lab expert and benefit from our workshops and online training program

Professional training of your staff helps you achieve perfect results in your laboratory every day. Our courses will teach you how to perform workflows in a straightforward manner as well as how to handle and maintain your instruments.



Our aim is to develop the necessary expertise within your team and to find practical solutions to your specific questions. On our website, we offer various workshops and webinars on specific laboratory topics in the areas of manual and automated Liquid Handling, Sample Handling, Cell Handling and Bioprocessing.

### On-site and In-house Training

#### Workshops at Eppendorf Training Centers

Our courses include purely theoretical seminars as well as theoretical seminars in combination with hands-on training. All workshops are held at our specially equipped laboratory training centers in Hamburg (Germany), Kuala Lumpur (Malaysia), and Namur (Belgium). These courses cover between 1 and 3 days and are open for single or group registrations.

#### In-house training events

For larger groups, you have the option of booking a workshop or seminar directly at your company's site. The contents of your training will be tailored to your specific requirements.

#### Training events at EMBL

Additional courses are offered in co-operation with the renowned European Molecular Biology Laboratory EMBL in Heidelberg (Germany).

#### What to expect

- > In-depth expertise
- > High quality hands-on training
- > Individual support in small groups
- > Intensive exchange of expertise between specialists
- > Modern training laboratories and classrooms
- > Extensive course material
- > Certificate of participation

### Online Training and Special Laboratory Information

#### Online Training Portfolio

Our webinars cover diverse topics, which include: scientific questions, application issues, calibration aspects and ergonomic features. You may participate in the live sessions or view the recordings at a later time.

#### Eppendorf Handling Solutions

This platform provides you with helpful and diversified information on interesting laboratory topics. Concrete solutions support you in making your job in the lab easier and more efficient. Additional material, such as posters, laboratory schedules, application notes or illustrative videos and clips can be viewed or downloaded at:

[www.eppendorf.com/handlingsolutions](http://www.eppendorf.com/handlingsolutions)

#### How to register

For detailed information on our comprehensive training program and to access the registration form, please visit our website:

[www.eppendorf.com/training](http://www.eppendorf.com/training)



## Training Contents



### Liquid Handling

The correct use of liquid handling systems is fundamental for reliable research results. By participating in this seminar, you will take home the following knowledge and skills:

- > When to use which liquid handling system
- > Correct pipetting techniques, decontamination and maintenance
- > Introduction to basic statistical methods
- > Calibration in accordance with ISO 8655



### Cell Handling

Develop good practice and aseptic techniques and understand the needs of cell culture

- > From freezing to passaging: essentials of cell cultivation
- > Understanding and preventing contamination
- > Good cell culture practice
- > Optimizing reproducibility in cell culture



### Automation – Working successful with the epMotion®

The objective is to provide basic knowledge and skills about how to run standard applications using the epMotion software.

### Molecular Biology

We offer various molecular biology courses, such as introductory DNA cloning, basic and advanced PCR troubleshooting and optimization techniques, as well as on-demand customized courses. These courses aim to increase both theoretical and technical knowledge in the broad field of molecular biology.

### Bioprocess

Learn how to use your bioprocess system, including an introduction to the control software. Training may take place at the customer's site or in one of our Bioprocess Centers. We offer initial training and advanced courses, all tailored to the customer's particular needs.



### Micromanipulation Training at EMBL

The micromanipulation of single cells or tissues allows specific cell modifications and gene editing in order to address diverse questions in research. The following two courses, organized in collaboration with the EMBL in Heidelberg, impart basic knowledge and practice in the following micromanipulation techniques:

#### Microinjection into adherent cells

- > Semi-automated microinjection of fluorescent labeled DNA and protein constructs
- > Analysis of microinjected cells via fluorescence microscopy

#### Transgenic Animals – Micromanipulation techniques

- > Pronuclear or cytoplasmic injection of fertilized mouse oocytes
- > Injection of embryonic stem cells into mouse blastocysts and morulae
- > Piezo-assisted cell transfer into 8-cell stage embryos

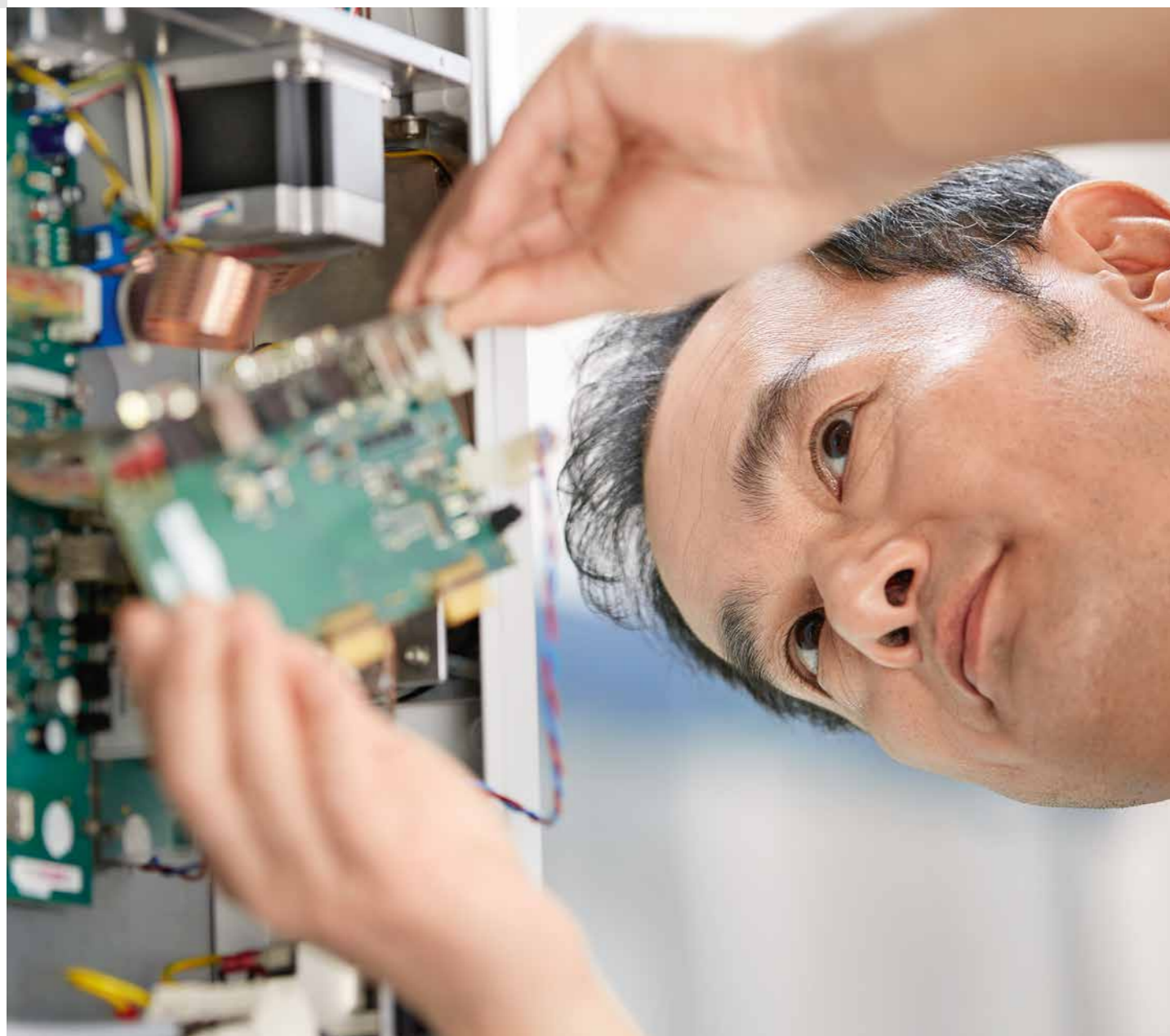

# Technical Service



Eppendorf is committed to providing complete service plans for your instruments to help you maintain premium performance of our instruments in your laboratory. Our technical and certification services will give you the sense of security over your instrument uptime, performance guaranteed by the high quality of our original spare parts. We inspect your instrument and provide a detailed report of its present condition as well as an estimate for maintenance, certification, or repair services, if deemed necessary.

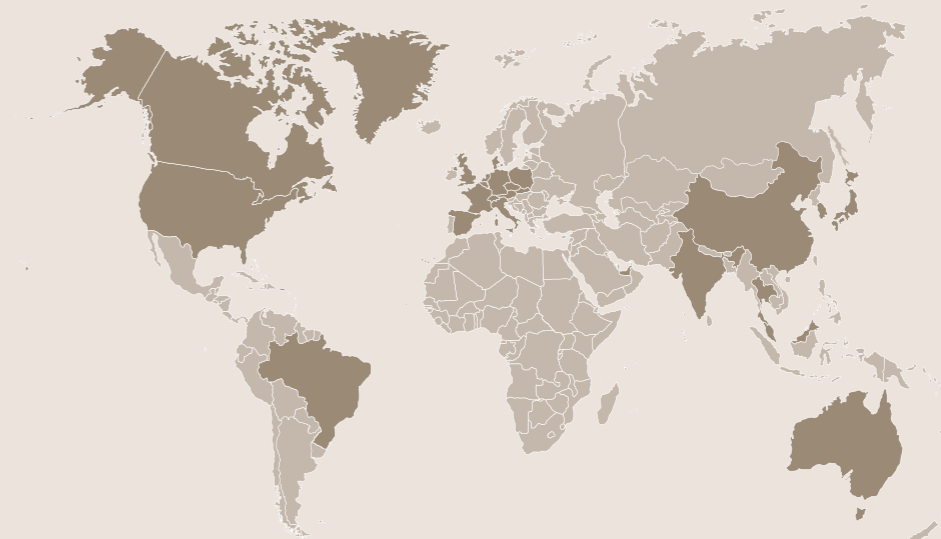

- Eppendorf Service Organization
- Eppendorf-trained and certified Service Provider

#### Peace of mind

With just one phone call or service request through our webpage you can access our network of highly skilled service professionals. Our qualified service staff ensure timely and accurate resolutions are provided with professional guidance and care worldwide. For any technical support please contact your local service organization.

#### Long-term value

For the most productive long life and highest uptime of your Eppendorf instrument, we can provide complete and thorough technical support from pre-site inspection through installation, maintenance, certification, and repair services.

Through highly qualified service engineers, either available to come on site or at local service centers your system will always be up to date. We will manage enhanced features or available options you select to keep you on track with the state-of-the-art work in your field.

For more information go to [www.eppendorf.com/epServices](http://www.eppendorf.com/epServices).

#### From the experts

Our Service Professionals in our three major centers of service excellence are all manufacturer trained and qualified at the headquarters and competence centers in Germany, the United States, and Malaysia to satisfy your high expectations on the quality of our product and service performance.

We provide technical support to 19 countries around the globe with consistent on-site service through our own service organizations, and to all other countries through our contract service provider network.



# Pipette Performance Plans

## Preventive Maintenance, Calibration and Adjustment Services

Precision and accuracy of the pipettes are important for the quality of all your work results. Regular maintenance and calibration by Eppendorf assures a consistent result quality.

We offer a range of service options from basic calibration at an economical price to custom designed calibration services (i.e. GLP). We provide quality pipette calibration, certification, maintenance and repair services – for all major brands of pipettes – not just our own.



### BASIC

Affordable calibration according to ISO 8655

### STANDARD

Maintenance and calibration according to ISO 8655

### PREMIUM

Total Care certification services for pipettes according to ISO 8655

- > Calibration according to ISO 17025
- ISO 17025 accredited calibration services

- > CUSTOMIZED
- e.g. testing according to customer specifications (i.e. GLP) specifications

### Additional services

- > Trade-in program
- > Reminder of service intervals
- > Customized maintenance contracts
- > Inspection of pipettes from all manufacturers – not just Eppendorf
- > Emergency service
- > On site service
- > Pipette training, with emphasis in ergonomics (PhysioCare Concept®)

### Value of service

- > Consistent, reliable pipettes
- > Highest confidence in results
- > GLP supporting documentation

Spa and Wellnes for your pipettes to generate reproducible results



Relax a moment and watch this short video: Scan the QR code or go to [www.eppendorf.com/pipette-video](http://www.eppendorf.com/pipette-video)



Service Operation	BASIC	STANDARD	PREMIUM	Calibration ISO 17025	CUSTOMIZED
Order Number for calibration for Fixed-Volume Pipettes	0050 600.015	0050 600.017	0050 600.025	0082 000.000	on request
Order Number for calibration for Adjustable-Volume Pipettes	0050 600.071	0050 600.076	0050 600.084	0082 000.001	on request
Order Number for calibration for 8-Channel Pipettes	0050 600.116	0050 600.122	0050 600.092	0082 000.002	on request
Order Number for calibration for 12-Channel Pipettes	0050 600.128	0050 600.130	0050 600.033	0082 000.003	on request
Order Number for calibration for Hand Dispenser	0050 600.071	0050 600.076	0050 600.084	0082 000.001	on request
Initial inspection to determine pipette condition			■		
Replace all defective parts <sup>2)</sup>			■		
Maintenance and Cleaning		■	■	■	
Cleaning and lubrication of seals, O-rings and piston, replacement of small parts like seals and O-rings, checking seals for damage/integrity					
Calibration		■	■	■	
Calibration according to ISO 8655 specifications with 10 measurements per test volume (min, mid, max) <sup>4)</sup>					
Quick Check according to ISO 8655 specifications with 4 measurements per test volume (min, mid, max) <sup>4)</sup>	■	■ <sup>3)</sup>	■ <sup>3)</sup>	■	
Documentation		■	■	■	
Issue calibration report					
Supporting Information	3 – 5	3 – 5	3 – 5	3 – 5	
Service turnaround (from time of receipt, in business days) <sup>1)</sup>					

<sup>1)</sup> Standard value, deviations possible, excl. shipping duration. <sup>2)</sup> Handgrip, motor and PCB are priced separately. <sup>3)</sup> Is included in the 10 measurements. <sup>4)</sup> 10 %, 50 % and 100 % of nominal volumes.

## epMotion® and GxP Software Certification Plans

### Certification Services

Eppendorf offers global certification services to facilitate the customer's validation process according to FDA 21 CFR Part 11, EU GMP Annex 11, GLP and GAMP® 5 over the complete lifecycle, by supporting in the Installation and Operational Qualification (IQ/OQ) process of the instrument and epMotion® GxP software. The entire qualification will be documented in detail and the user personnel will be extensively trained and certified.



### Value of service

- > System performance verifiably complies with the specifications
- > GLP supporting documentation
- > Reduced validation costs through standardized qualification and documentation

### Good practice in Motion

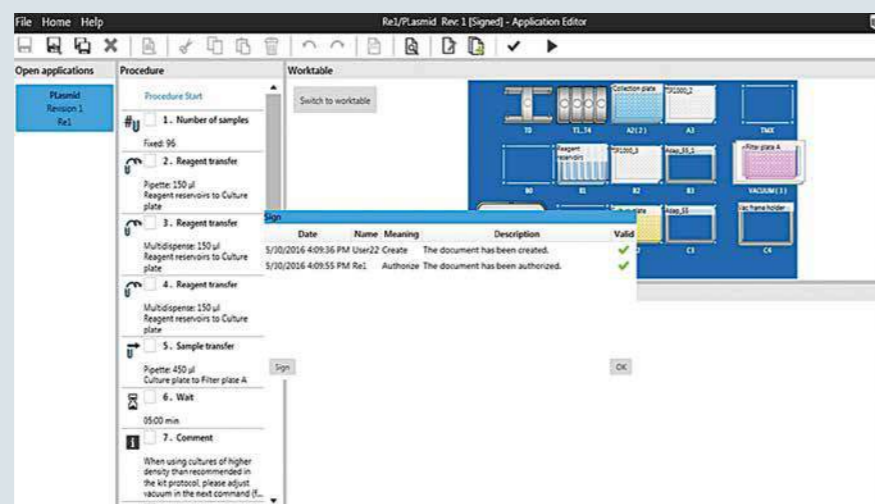

For more information go to [www.eppendorf.com/epServices](http://www.eppendorf.com/epServices). Performance Plans are available in selected countries only and service offer may differ.



Certification Plans	BASIC	STANDARD	PREMIUM
<b>Order Number</b>	5075 005.182	5075 005.190	5075 005.204
<b>Installation and Operational Qualification (IQ/OQ):</b> according to Eppendorf SOPs incl. 1 single and 1 × 8-channel dispensing tool calibration (based on ISO 8655), complete documentation and certificates	■	■	■
<b>epMotion®/epBlue™ User Starter Training:</b> incl. training documents and certificates	■	■	■
<b>epMotion® GxP Software User, Administrator Lab and Administrator IT Training:</b>	■	■	■
<b>Lab Automation Seminar/Workshop:</b> incl. training documents and certificates at Eppendorf Training Center - one person. epMotion® basics incl. training documents and certificates		■	■
<b>epMotion® GxP Software Seminar/Workshop:</b> one person. Electronic signatures, audit trail, Barcode ID, archiving, administrator functions (21 CFR Part 11, GAMP 5) incl. training documents and certificates			■
<b>epMotion® Application Support:</b> customized one day support (e.g. support with customer method programming)			■
<b>Consultancy for Validation Process and GxP Software:</b> incl. Validation Plan, Performance Qualification and Validation Report templates one day consultancy support			■

Additional Services:	Order no.
<b>epMotion® GxP Software Upgrade, Installation and User/Administrator Training, epMotion®/epBlue™ Version</b>	5075 005.220
<b>epMotion® GxP Software Operational Qualification (OQ),</b> according to Eppendorf SOP's, incl. 1 single channel and 1 × 8 channel dispensing tool calibration (based on ISO 8655)	5075 005.212
<b>epMotion® GxP Software – single channel dispensing tool calibration</b> (based on ISO 8655)	5075 005.239
<b>epMotion® GxP Software – 8-channel dispensing tool calibration</b> (based on ISO 8655)	5075 005.247
<b>Calibration/Temperature Adjustment TMX ThermoMixer® Module</b> (epMotion® 5075 TMX/M, 5073/t/vt)	5075 005.174
<b>Calibration/Adjustment for each Thermal Module</b> (epMotion® 5075)	5075 005.018
<b>Maintenance, Cleaning, exchange of wear and tear parts</b>	on request
<b>Re-qualification (customer-specific),</b> after changes of system/process or environment	5070 005.052
<b>Shut Down Services</b>	5075 005.255
<b>epMotion® GxP Software User Training</b>	5075 005.263
<b>Eppendorf Training Center "Lab Automation Seminar/Workshop"</b> – one person	on request
<b>Eppendorf Training Center "epMotion® GxP Software Seminar/Workshop"</b> – one person	on request
<b>epMotion® Application Support</b>	5075 005.271

## epMotion® Performance Plans



### epMotion Performance Plans

epMotion and its dispensing tools are precision instruments. As such, they should be regularly maintained and calibrated, which will help ensure continuing high accuracy, precision and reproducibility. With our Performance Plans options we help you maintain premium performance of your epMotion over an extended period of time. Our qualified service technicians will take care of your instrument. Our Certification Services include all function tests, calibration and adjustment services needed for Installation and Operational Qualification (IQ/OQ) of your instrument.

### Dispensing tools calibration

Calibration of the dispensing tools are based on ISO 8655 supporting your GLP documentation.

### Order Numbers for epMotion Application Support:

#### Field Application Support Level 1: 0082 030.160

> Covers standard applications (e.g. PCR setup, sample normalization) – up to two days support

#### Field Application Support Level 2: 0082 030.161

> Covers advanced applications (e.g. DNA/RNA isolation, ELISA, qualified NGS library preparation) – up to four days support

#### Field Application Support Level 3: 0082 030.162

> Covers very complex applications, where an initial suitability test must be performed – up to eight days support

#### Initial inspection of the liquid characteristics: 0082 030.169

> Initial inspection of the liquid  
> Adjustment of liquid class parameters  
> Confirmation that liquid is handled to the best of the instrument's capability

Find more information about our training program at [www.eppendorf.com/training](http://www.eppendorf.com/training)

### Value of service

- > Confidence in high quality results and instrument reliability
- > Simple service process
- > Professional maintenance

### Keep your process in motion!

**eppendorf**

Performance tested on

Model: \_\_\_\_\_

Serial no.: \_\_\_\_\_

Serviced by: \_\_\_\_\_

Service no.: \_\_\_\_\_

Next service: \_\_\_\_\_

Date: \_\_\_\_\_

**epServices**  
for premium performance

For more information go to [www.eppendorf.com/epServices](http://www.eppendorf.com/epServices). Performance Plans are available in selected countries only and service offer may differ.



Service Operation	ESSENTIAL CHECK	ADVANCED MAINTENANCE	PREMIUM SERVICE	Installation Qualification (IQ)	Operational Qualification (OQ)
<b>Order Number for epMotion® 5070</b>	0082 030.013	0082 030.014	0082 030.015	0082 030.017	0082 030.018
<b>Order Number for epMotion® 5073</b>	0082 030.033	0082 030.034	0082 030.035	0082 030.037	0082 030.038
<b>Order Number for epMotion® 5075</b>	0082 030.023	0082 030.024	0082 030.025	0082 030.027	0082 030.028
<b>Cleaning and Maintenance</b>					
Cleaning of housing/accessories	■	■	■		
Checking epMotion® for external visible damages	■	■	■	■	■
Exchange of CAN bus cables/O-rings of dispensing tools		■	■		
Software update <sup>1)</sup>	■	■	■	■	■
<b>Functional Check</b>					
Instrument set-up, initial operation, instruction of user				■	
Tip ejector, level sensor and carrier	■	■	■		■
Barcode Scanner with epBlue™ ID <sup>1)</sup>	■	■	■		
Thermal modules <sup>1)</sup> and vacuum chamber <sup>1)</sup>	■	■	■	■	■
TMX module <sup>1)</sup> /TMX module w. Magnetic Finger module <sup>1)</sup>	■	■	■	■	■
UV light/CleanCap (HEPA Filter) <sup>1)</sup>	■	■	■	■	■
<b>Memory</b>					
Evaluation of stored data		■	■		
<b>Verification</b>					
Calibration/adjustment of level sensor and carrier		■	■	■	■
Calibration/adjustment of vacuum chamber <sup>1)</sup>		■	■		
Verification of operating parameters acc. to specifications					■ <sup>3)</sup>
<b>Documentation</b>					
Check List provided	■	■	■		
Dated service sticker to confirm Eppendorf service	■	■	■	■	■
IQ Report and Certificate				■	
OQ Report and Certificate					■
<b>Supporting Information</b>					
Contract period	one year	one year	one year	n/a	n/a
Number of preventive services included	one	one	one	n/a	n/a
Cost of repairs/parts replacement outside scope of preventive maintenance visit (where Eppendorf product warranty has expired)	not included	not included	discount on parts, labor, travel time <sup>2)</sup>	n/a	n/a

### Order Numbers for combined Installation and Operational Qualification (IQ/OQ) services:

> For epMotion® 5070: 0082 030.019

> For epMotion® 5073: 0082 030.039

> For epMotion® 5075: 0082 030.029

### Order Numbers for additional services:

> 1-chan. dispensing tool calibration (< epBlue™ 40.0): 0050 600.036

> 8-chan. dispensing tool calibration (< epBlue™ 40.0): 5070 005.044

> 1-chan. dispensing tool calibration (≥ epBlue™ 40.0): 0050 600.255

> 8-chan. dispensing tool calibration (≥ epBlue™ 40.0): 0050 600.259

> Thermal module calibration: 5075 005.018

> TMX Module calibration: 5075 005.174

> HEPA filter exchange: 5073 920.061

> UV lamp exchange: 5073 920.070

**Additionally, if you require a Customized Service, exchanges of spare parts, we will be very pleased to discuss your requirements.**

<sup>1)</sup> Where feature is present. <sup>2)</sup> Please contact your local Eppendorf Service representative for details of discounts and/or any potential additional charges applying.

<sup>3)</sup> The detailed certification service contents are listed in the OQ Report.

## epMotion® 96 Performance Plans



### epMotion 96 Performance Plans

The Eppendorf epMotion 96 is a semi-automated electronic pipette for fast and precise parallel 96 channel microplate processing. The reliability of the electronic parallel pipetting system movement is the prerequisite for high precision and reproducibility of the results across the whole 96 or 384 well plate. Maintaining and verifying your systems accuracy and precision on a regular basis is thus highly recommended to make sure your system still dispenses according to the specification.

In the end you will receive assured results with your downstream applications and your valuable samples and reagents. Eppendorf offers a range of services for different user requirements including GLP supporting documentation.

#### Value of service

- > Confirmation of performance with manufacturer specifications
- > Confidence in results
- > GLP supporting documentation

**96 x confidence by verified performance!**

**eppendorf**

Performance tested on

Model: \_\_\_\_\_

Serial no.: \_\_\_\_\_

Serviced by: \_\_\_\_\_

Service no.: \_\_\_\_\_

Next service: \_\_\_\_\_

Date: \_\_\_\_\_

**epServices**  
for premium performance

For more information go to [www.eppendorf.com/epServices](http://www.eppendorf.com/epServices). Performance Plans are available in selected countries only and service offer may differ.

Technical specifications subject to change.



Service Operation	ESSENTIAL CHECK	ADVANCED MAINTENANCE	PREMIUM SERVICE	Installation Qualification (IQ)	Operational Qualification (OQ)
<b>Order Number</b>	0082 030.003	0082 030.004	0082 030.005	0082 030.007	0082 030.008
<b>Checks and Maintenance</b>					
Cleaning		■	■		
Lubrication of dispensing head		■	■		
Checking and exchanging of 96 O-rings from cones	■	■	■		
Software/firmware update if applicable		■	■		
<b>Verification (Calibration)</b>					
Leak Test (50 µL + 300 µL)	■	■	■	■	■
Gravimetric Test – systematic error (50 µL + 300 µL)		■	■		■
Photometric Test – random error (2 volumes)		■	■		■
<b>Documentation</b>					
Check List provided	■	■	■		
Dated service sticker to confirm Eppendorf service	■	■	■	■	■
Calibration Report		■	■		■
IQ Report				■	
OQ Report/Certificate					■
<b>Supporting Information</b>					
Contract period	one year	one year	one year	n/a	n/a
Number of preventive services included	one	one	one	n/a	n/a
Cost of repairs/parts replacement outside scope of preventive maintenance visit (where Eppendorf product warranty has expired)	not included	not included	discount on block exchange, labor, travel time <sup>1)</sup>	n/a	n/a
<b>Order Number for combined Installation and Operational Qualification (IQ/OQ) services: 0082 030.009</b>					
<b>Additionally, if you require a Customized Service we will be very pleased to discuss your requirements.</b>					

<sup>1)</sup> Please contact your local Eppendorf Service representative for details of discounts and/or any potential additional charges applying.

# Temperature Control and Mixing Performance Plans



### Temperature Control and Mixing Performance Plans

The right heating, cooling and mixing conditions are made very easy with our Temperature Control and Mixing instruments. We also understand that slight deviations in temperature and mixing frequency of your samples can affect their reaction conditions and may lead to non-reproducible results. To guarantee you the precise function of the instrument we offer manufacturer designed maintenance services. Our certification services support your Quality Management requirements with Installation Qualification (IQ) and Operational Qualification (OQ) in accordance with manufacturer's specifications.

With our Performance Plans options we will make sure that your instruments are in good working condition by professional maintenance and certification service.

### Value of service

- > Reliable system operation and results
- > GLP supporting documentation

### We care for your samples – with our mix of services

**eppendorf**

Performance tested on

Model: \_\_\_\_\_

Serial no.: \_\_\_\_\_

Serviced by: \_\_\_\_\_

Service no.: \_\_\_\_\_

Next service: \_\_\_\_\_

Date: \_\_\_\_\_

**epServices**  
for premium performance

For more information go to [www.eppendorf.com/epServices](http://www.eppendorf.com/epServices). Performance Plans are available in selected countries only and service offer may differ.



Service Operation	ESSENTIAL CHECK	ADVANCED MAINTENANCE	PREMIUM SERVICE	Installation Qualification (IQ)	Operational Qualification (OQ)
<b>Order Number</b>	0082 100.003	0082 100.004	0082 100.005	0082 100.007	0082 100.008
<b>External Checks and Maintenance</b>					
Cleaning of housing		■	■		
Visual check of housing	■	■	■		
Visual check of plate holder		■	■		
Cleaning of accessories		■	■		
Visual check of accessories	■	■	■		
<b>Internal Equipment and Fittings</b>					
Cleaning of internal parts and assemblies		■	■		
Visual check of internal parts and assemblies		■	■		
Visual check of electrical connection		■	■		
<b>Functional check</b>					
Check of delivery				■	
Instrument set-up and initial operation				■	
Instruction of user				■	
LED, display, and keyboard check		■	■		
Check of vortex sensor		■	■		
Functional check with service functions		■	■		
Check of SmartBlock or exchangeable thermoblock detection	■	■	■		■
Check of mixing, heating, cooling, and vortexing <sup>2)</sup>	■	■	■		
Check and measurement of mixing, heating, cooling, and vortexing					■
Check of overload protection		■	■		
Check of fans		■	■		
Check of ThermoTop detection		■	■		
Check of timer					■
<b>Memory</b>					
Evaluation of stored data		■	■		
<b>Documentation</b>					
Check list provided	■	■	■		
Dated service sticker to confirm Eppendorf service	■	■	■	■	■
IQ Report and Certificate				■	
OQ Report and Certificate					■
<b>Supporting Information</b>					
Contract period	one year	one year	one year	N/A	N/A
Number of preventive services included	one	one	one	N/A	N/A
Costs of repairs/parts replacement outside scope of preventive maintenance visit (where Eppendorf product warranty has expired)	not included	not included	discount on parts, labor, travel time <sup>1)</sup>	N/A	N/A

**Order Number for combined Installation and Operational Qualification (IQ/OQ) services: 0082 100.009**  
**Additionally, if you require a Customized Service we will be very pleased to discuss your requirements.**

<sup>1)</sup> Please contact your local Eppendorf Service representative for details of discounts and/or any potential additional charges applying. <sup>2)</sup> Without measurement.



# Centrifuge Performance Plans



### Centrifuge Performance Plans

Quality Management Systems increasingly ask for regular service of centrifuges and rotors in either an operational or a disassembled state to ensure a safe working environment. Functional inspections ensure that all technical specifications, such as temperature accuracy, rotational speed and operating time comply with the manufacturer specifications. The Centrifuge Performance Plans assist with your preparation for internal and external audits.

### Value of service

- > Highest degree of security in your lab
- > GLP supporting documentation
- > Longer service life of the system

Relax while your samples are spinning safely!



Take a break and watch this video about recommended routine maintenance of your centrifuge  
[www.eppendorf.com/centrifuge-video](http://www.eppendorf.com/centrifuge-video)

**eppendorf**

Performance tested on

Model: \_\_\_\_\_

Serial no.: \_\_\_\_\_

Serviced by: \_\_\_\_\_

Service no.: \_\_\_\_\_

Next service: \_\_\_\_\_

Date: \_\_\_\_\_

**epServices**  
for premium performance

For more information go to [www.eppendorf.com/epServices](http://www.eppendorf.com/epServices). Performance Plans are available in selected countries only and service offer may differ.



Service Operation	ESSENTIAL CHECK	ADVANCED MAINTENANCE	PREMIUM SERVICE	Installation Qualification (IQ)	Operational Qualification (OQ)
<b>Order Number for Microcentrifuge w/o Refrigeration</b>	0082 020.003	0082 020.004	0082 020.005	5424 860.036	0082 020.008
<b>Order Number for Microcentrifuge with Refrigeration</b>	0082 020.013	0082 020.014	0082 020.015	5424 860.044	0082 020.018
<b>Order Number for Multipurpose Centrifuge w/o Refrigeration</b>	0082 020.023	0082 020.024	0082 020.025	5810 860.040	0082 020.028
<b>Order Number for Multipurpose with Refrigeration</b>	0082 020.033	0082 020.034	0082 020.035	5810 860.059	0082 020.038
<b>Cleaning and Maintenance</b>					
Cleaning of housing/Checking condensation water tray <sup>1)</sup>	<input type="checkbox"/>	<input type="checkbox"/>	<input type="checkbox"/>		
Cleaning and checking of rotor bowl and internal parts		<input type="checkbox"/>	<input type="checkbox"/>		
Checking of instrument for any damage	<input type="checkbox"/>				<input type="checkbox"/>
Checking of stability, housing, display and keypad		<input type="checkbox"/>	<input type="checkbox"/>		
Checking of display and keypad/Software update if required		<input type="checkbox"/>	<input type="checkbox"/>		
Checking of lid latch	<input type="checkbox"/>	<input type="checkbox"/>	<input type="checkbox"/>		<input type="checkbox"/>
<b>Functional check</b>					
Instrument set-up/Initial operation/Instruction of user				<input type="checkbox"/>	
Checking of rotor detection	<input type="checkbox"/>	<input type="checkbox"/>	<input type="checkbox"/>		
Checking of temperature sensors <sup>1)</sup> and speed sensor		<input type="checkbox"/>	<input type="checkbox"/>		<input type="checkbox"/>
Checking of imbalance detection <sup>1)</sup>		<input type="checkbox"/>	<input type="checkbox"/>		
Performing system test run	<input type="checkbox"/>	<input type="checkbox"/>	<input type="checkbox"/>	<input type="checkbox"/>	<input type="checkbox"/>
<b>Memory</b>					
Evaluating of stored data		<input type="checkbox"/>	<input type="checkbox"/>		
<b>Verification</b>					
Verification of operating parameters acc. to specifications					<input type="checkbox"/> <sup>3)</sup>
<b>Documentation</b>					
Check List provided	<input type="checkbox"/>	<input type="checkbox"/>	<input type="checkbox"/>		
Dated service sticker to confirm Eppendorf service	<input type="checkbox"/>	<input type="checkbox"/>	<input type="checkbox"/>	<input type="checkbox"/>	<input type="checkbox"/>
IQ Report and Certificate				<input type="checkbox"/>	
OQ Report and Certificate					<input type="checkbox"/>
<b>Supporting Information</b>					
Contract period	one year	one year	one year	N/A	N/A
Number of preventive services included	one	one	one	N/A	N/A
Costs of repairs/parts replacement outside scope of preventive maintenance visit (where Eppendorf product warranty has expired)	not included	not included	discount on parts, labor, travel time <sup>2)</sup>	N/A	N/A

**Additional Order Numbers for combined Installation and Operational Qualification (IQ/OQ) services:**

- > for microcentrifuge w/o refrigeration: 0082 020.009
- > for microcentrifuge with refrigeration: 0082 020.019
- > for multipurpose w/o refrigeration : 0082 020.029
- > for multipurpose with refrigeration: 0082 020.039

**Additionally, if you require a Customized Service we will be very pleased to discuss your requirements.**

<sup>1)</sup> Where feature is present. <sup>2)</sup> Please contact your local Eppendorf Service representative for details of discounts and/or any potential additional charges applying. <sup>3)</sup> The detailed certification service contents are listed in the OQ Report.

# Rotor Assurance Plans



### Inspection Services

Rotors and buckets are subject to normal wear and tear during regular operation and may be damaged as a result. Surface scratches, among others, can affect the chemical resistance and accelerate the corrosion process. The stress of high number of cycles increases the likelihood of microscopic cracks. These microcracks can be detected early on during a qualified inspection, which will allow the rotor to be exchanged before serious damage has occurred.

Our certified, qualified service technicians use sophisticated borescope devices to detect invisible, yet critical, cracks and scratches. If none or very few surface changes are identified, the rotor can be used according to instructions - or for an additional year if the inspection was performed at the end of the recommended service life.

### Value of service

- > Sample integrity and consistent performance
- > Maximizing rotor service life
- > Confidence for safest operation
- > Rotor care/use instructions
- > Discount on new rotor

### Confidence comes through professional inspection!



Take a break and watch this video about recommended routine maintenance of your centrifuge  
[www.eppendorf.com/centrifuge-video](http://www.eppendorf.com/centrifuge-video)

For more information go to [www.eppendorf.com/epServices](http://www.eppendorf.com/epServices). Performance Plans are available in selected countries only and service offer may differ.



Inspection Service for Rotors	Recommended Service Periods	Group 1 Fixed-Angle Rotors	Group 2 Fixed-Angle Rotors	Group 3 Swing-Bucket Rotors and Buckets
Visual rotor check <sup>1)</sup>	Annually	F-45-12-11, F-45-24-11, F-45-30-11, FA-45-18-11, FA-45-24-11 series, FA-45-30-11, F-45-18-17-Cryo	F-35-6-30, F-34-6-38, FA-45-6-30	A-2-MTP, A-2-DWP, A-4-44, A-4-62, A-4-81
Advanced rotor check	From twice per service life to annually	5424 860.109	5424 860.109	5810 860.113
		5424 860.206	5810 860.237	5810 860.245

<sup>1)</sup> For all Eppendorf rotors and accessories

Order Number for obligatory check of rotor according to country-specific regulations: 5424 860.150

### Attention:

All rotors must be clean and dry before inspection, or additional cleaning charges apply at prevailing rates.

# Mastercycler® Performance Plans



### Mastercycler Performance Plans

To ensure your instrument is operating consistently at peak performance and to guarantee reproducible results over an extended period of time, we offer service programs to meet your needs. Our maintenance service is a prerequisite for temperature verification of the cyclers. The exact compliance of defined temperatures is critical for reproducible results.

Our certification services can support your Quality Management requirements by Installation Qualification (IQ) and Operational Qualification (OQ) in accordance with manufacturers' specifications to guarantee you the precise function of the instrument. With our Performance Plans options we will make sure that your instruments are in good working condition by professional maintenance and certification service from the manufacturer.

### Value of service

- > High confidence in results
- > Permanently reliable and reproducible results
- > GLP supporting documentation

### Keep operating – with absolute confidence

### Additional stand-alone temperature verification and certification services:

#### Sequential temperature verification - measuring one temperature at the time

##### Order Number:

- > for Mastercycler® X50, pro, nexus: 6321 897.000
- > temperature verification system (calibrated according to ISO 17025): 0082 040.027

#### Parallel temperature verification - measuring various wells at the same time and of ramping speeds between 40-90 °C.

##### Order Number:

- > for Mastercycler® X50, pro, nexus, in selected countries: 6321 897.507

Please inquire locally for ordering information on Certification of Temperature Verification systems (Single-well and multi-well)

**eppendorf**

Performance tested on

Model: \_\_\_\_\_

Serial no.: \_\_\_\_\_

Serviced by: \_\_\_\_\_

Service no.: \_\_\_\_\_

Next service: \_\_\_\_\_

Date: \_\_\_\_\_

**epServices**  
for premium performance

For more information go to [www.eppendorf.com/epServices](http://www.eppendorf.com/epServices). Performance Plans are available in selected countries only and service offer may differ.



Service Operation	ESSENTIAL CHECK	ADVANCED MAINTENANCE	PREMIUM SERVICE	Installation Qualification (IQ)	Operational Qualification (OQ)
<b>Order Number for Mastercycler® X50, pro, nexus</b>	0082 040.043	0082 040.044	0082 040.045	0082 040.047	0082 040.048
<b>External Checks and Maintenance</b>					
Cleaning of MC module		■	■		
Visual check of housing	■	■	■		
Cleaning of heated lid		■	■		
Visual check of accessories		■	■		
<b>Internal Equipment and Fittings</b>					
Cleaning of internal parts and assemblies		■	■		
Visual check of internal parts and assemblies		■	■		
Visual check of electrical connection (incl. mains power)		■	■		
Software update		■	■		
<b>Functional Check</b>					
Check of delivery				■	
Instrument set-up and initial operation				■	
Instruction of the user				■	
LED, display and keyboard check	■	■	■	■	■
Check USB-interface		■	■	■	■
Check touchscreen		■	■	■	■
Check of thermoblock	■	■	■	■	■
Check of heated lid	■	■	■	■	■
Check of fan(s)	■	■	■	■	■
Temperature verification – with single-channel system		■	■	■	■
Temperature verification – with multi-channel system (if available <sup>1)</sup> )		■	■	■	■
<b>Memory</b>					
Evaluation of stored data		■	■		
<b>Documentation</b>					
Check List provided	■	■	■		
Dated service sticker to confirm Eppendorf service	■	■	■	■	■
IQ Report and Certificate				■	
OQ Report and Certificate					■
<b>Supporting Information</b>					
Contract period	one year	one year	one year	n/a	n/a
Number of preventive services included	one	one	one	n/a	n/a
Cost of repairs/parts replacement outside scope of preventive maintenance visit (where Eppendorf product warranty has expired)	not included	not included	discount on parts, labor, travel time <sup>1)</sup>	n/a	n/a

### Order Numbers for combined Installation and Operational Qualification (IQ/OQ) services:

- > For Mastercycler® 0082 040.039
- > For Mastercycler® X50, pro, nexus: 0082 040.049
- > Additionally, if you require a Customized Service we will be very pleased to discuss your requirements.

<sup>1)</sup> Please contact your local Eppendorf Service representative for details of discounts and/or any potential additional charges applying.

# ULT Freezer Performance Plans



**eppendorf**

Performance tested on

Model: \_\_\_\_\_

Serial no.: \_\_\_\_\_

Serviced by: \_\_\_\_\_

Service no.: \_\_\_\_\_

Next service: \_\_\_\_\_

Date: \_\_\_\_\_

**epServices**  
for premium performance

### ULT Freezer Performance Plans

Eppendorf Ultra-Low Temperature (ULT) Freezers offer you the advanced design and intuitive features you like on the outside plus the security and performance you need for your most precious samples on the inside. Reliable and efficient performance can be expected for years of smooth operation from any of our ULT Freezers, which vary in configuration and capacity. In addition to our extensive standard warranty, Eppendorf offers ULT Freezer Performance Plans to suit your lab's needs while enhancing your peace of mind.

You can choose between essential function checks, preventive maintenance plans, or Installation and Operational (IQ/OQ) certification services. These protocols are designed to check, validate, and promote reliable freezer performance that coincide with our manufacturer's specifications.

### Value of service

- > Reduced risk of system failure
- > Long lifetime of instruments
- > Confirmation of performance within manufacturer specification

### Protect your priceless samples!

For more information go to [www.eppendorf.com/epServices](http://www.eppendorf.com/epServices). Performance Plans are available in selected countries only and service offer may differ.



Service Operation	ESSENTIAL CHECK	ADVANCED MAINTENANCE	PREMIUM SERVICE	Installation Qualification (IQ)	Operational Qualification (OQ)
<b>Order Number</b>	0082 070.003	0082 070.004	0082 070.005	0082 070.007	0082 070.008
<b>External Checks and Maintenance</b>					
Check installation environment	<input type="checkbox"/>	<input type="checkbox"/>	<input type="checkbox"/>	<input type="checkbox"/>	<input type="checkbox"/>
Check electrical supply and fittings	<input type="checkbox"/>	<input type="checkbox"/>	<input type="checkbox"/>	<input type="checkbox"/>	<input type="checkbox"/>
Check CO <sub>2</sub> /LN <sub>2</sub> backup system installation <sup>1)</sup>	<input type="checkbox"/>	<input type="checkbox"/>	<input type="checkbox"/>	<input type="checkbox"/>	<input type="checkbox"/>
Check independent temperature monitoring system <sup>1)</sup>	<input type="checkbox"/>	<input type="checkbox"/>	<input type="checkbox"/>	<input type="checkbox"/>	<input type="checkbox"/>
Operation of freezer lid gas strut (chest freezer only)	<input type="checkbox"/>	<input type="checkbox"/>	<input type="checkbox"/>	<input type="checkbox"/>	<input type="checkbox"/>
Alignment of door handle	<input type="checkbox"/>	<input type="checkbox"/>	<input type="checkbox"/>	<input type="checkbox"/>	<input type="checkbox"/>
Alignment and sealing of outer door (upright freezer only)	<input type="checkbox"/>	<input type="checkbox"/>	<input type="checkbox"/>	<input type="checkbox"/>	<input type="checkbox"/>
Air filter inspection and cleaning	<input type="checkbox"/>	<input type="checkbox"/>	<input type="checkbox"/>	<input type="checkbox"/>	<input type="checkbox"/>
<b>Internal Equipment and Fittings</b>					
Inspection and cleaning of heated vent/condensor	<input type="checkbox"/>	<input type="checkbox"/>	<input type="checkbox"/>	<input type="checkbox"/>	<input type="checkbox"/>
Condition and function of inner doors/lids	<input type="checkbox"/>	<input type="checkbox"/>	<input type="checkbox"/>	<input type="checkbox"/>	<input type="checkbox"/>
Compressors: operating temperature check	<input type="checkbox"/>	<input type="checkbox"/>	<input type="checkbox"/>	<input type="checkbox"/>	<input type="checkbox"/>
Cooling fan: condition of fan motor, bearings, fan blades	<input type="checkbox"/>	<input type="checkbox"/>	<input type="checkbox"/>	<input type="checkbox"/>	<input type="checkbox"/>
Condition of insulation – accessible cooling circuit pipes	<input type="checkbox"/>	<input type="checkbox"/>	<input type="checkbox"/>	<input type="checkbox"/>	<input type="checkbox"/>
Condition of accessible electrical wiring	<input type="checkbox"/>	<input type="checkbox"/>	<input type="checkbox"/>	<input type="checkbox"/>	<input type="checkbox"/>
Display and function keys operation	<input type="checkbox"/>	<input type="checkbox"/>	<input type="checkbox"/>	<input type="checkbox"/>	<input type="checkbox"/>
Chamber temperature sensor function, alarms function	<input type="checkbox"/>	<input type="checkbox"/>	<input type="checkbox"/>	<input type="checkbox"/>	<input type="checkbox"/>
RS-232 communications port functionality check	<input type="checkbox"/>	<input type="checkbox"/>	<input type="checkbox"/>	<input type="checkbox"/>	<input type="checkbox"/>
<b>Validation and Metrology</b>					
Validation and adjustment of operating parameters to within Eppendorf specifications	<input type="checkbox"/>	<input type="checkbox"/>	<input type="checkbox"/>	<input type="checkbox"/>	<input type="checkbox"/> <sup>3)</sup>
<b>Documentation</b>					
Check List provided	<input type="checkbox"/>	<input type="checkbox"/>	<input type="checkbox"/>	<input type="checkbox"/>	<input type="checkbox"/>
Dated service sticker to confirm Eppendorf service	<input type="checkbox"/>	<input type="checkbox"/>	<input type="checkbox"/>	<input type="checkbox"/>	<input type="checkbox"/>
IQ Report and Certificate	<input type="checkbox"/>	<input type="checkbox"/>	<input type="checkbox"/>	<input type="checkbox"/>	<input type="checkbox"/>
OQ Report and Certificate	<input type="checkbox"/>	<input type="checkbox"/>	<input type="checkbox"/>	<input type="checkbox"/>	<input type="checkbox"/>
<b>Supporting Information</b>					
Contract period	one year	one year	one year	n/a	n/a
Number of preventive services	one	one	one	n/a	n/a
Cost of repairs/parts replacement outside scope of preventive maintenance visit (where Eppendorf product warranty has expired)	not included	not included	discount on parts, labor and travel time <sup>2)</sup>	n/a	n/a

**Order Number for combined Installation and Operational Qualification (IQ/OQ) services: 0082 070.009. Additionally, if you require a Customized Service we will be very pleased to discuss your requirements.**

<sup>1)</sup> Where this optional feature is present<sup>2)</sup> Please contact your local Eppendorf Service representative for details of discounts and/or any potential additional charges applying.  
<sup>3)</sup> The detailed certification service contents are listed in the OQ Report: e.g. test of battery, alarm, vacuum effectiveness, and final test run.

# Photometry Performance Plans



### Photometry Performance Plans

Qualitative and reproducible results depend upon quality instrumentation and measurements. To optimize photometric and fluorometric precision, accuracy, and linearity, your instrument should be routinely checked and adjusted by a qualified Eppendorf Service Technician.

Photometry Performance Plans include a choice of preventive maintenance programs which are designed to verify that your instrument meets manufacturer's specifications. We also take care of the optics cleaning, instrument adjustments and provide you with full documentation and certificates.

Installation Qualification (IQ) and Operational Qualification (OQ) certification services support your Quality Management requirements, providing you with qualified assurance that your photometer is delivering the highest possible quality results.

For more information go to [www.eppendorf.com/epServices](http://www.eppendorf.com/epServices). Performance Plans are available in selected countries only and service offer may differ.

### Value of service

- > Reliable system operation over the total system lifetime
- > GLP supporting documentation

### Stay tuned to the right wavelength!

**eppendorf**

Performance tested on

Model: \_\_\_\_\_

Serial no.: \_\_\_\_\_

Serviced by: \_\_\_\_\_

Service no.: \_\_\_\_\_

Next service: \_\_\_\_\_

Date: \_\_\_\_\_

**epServices**  
for premium performance



Service Operation	ESSENTIAL CHECK	ADVANCED MAINTENANCE	PREMIUM SERVICE	Installation Qualification (IQ)	Operational Qualification (OQ)
<b>Order Number for Eppendorf BioPhotometer®</b>	0082 110.003	0082 110.004	0082 110.005	0082 110.007	6132 005.018
<b>Order Number for Eppendorf BioSpectrometer®</b>	0082 110.013	0082 110.014	0082 110.015	0082 110.017	6135 005.019
<b>Cleaning and Maintenance</b>					
Cleaning of housing and cuvette shaft	<input type="checkbox"/>	<input type="checkbox"/>	<input type="checkbox"/>		
Cleaning and inspection of internal parts and light path		<input type="checkbox"/>	<input type="checkbox"/>		
Checking for damages	<input type="checkbox"/>	<input type="checkbox"/>	<input type="checkbox"/>	<input type="checkbox"/>	<input type="checkbox"/>
Inspection of housing/Testing of stability	<input type="checkbox"/>	<input type="checkbox"/>	<input type="checkbox"/>	<input type="checkbox"/>	
Software update		<input type="checkbox"/>	<input type="checkbox"/>		
<b>Functional Check</b>					
Instrument set-up, initial operation, instruction of user				<input type="checkbox"/>	
Checking of keyboard, and display	<input type="checkbox"/>	<input type="checkbox"/>	<input type="checkbox"/>		<input type="checkbox"/>
Testing of printer output and USB port (master/slave <sup>1)</sup> )	<input type="checkbox"/>	<input type="checkbox"/>	<input type="checkbox"/>		<input type="checkbox"/>
Setting number of flashes		<input type="checkbox"/>	<input type="checkbox"/>		
dsDNA test – 260 nm (Biophotometer plus)	<input type="checkbox"/>	<input type="checkbox"/>	<input type="checkbox"/>		
Self test (Biospectrometer/Biophotometer D30)	<input type="checkbox"/>	<input type="checkbox"/>	<input type="checkbox"/>	<input type="checkbox"/>	<input type="checkbox"/>
<b>Memory</b>					
Evaluation of stored data		<input type="checkbox"/>	<input type="checkbox"/>		<input type="checkbox"/>
<b>Verification</b>					
Photometer Test (wavelength systematic error/precision and photometric accuracy/fluorescence test <sup>1)</sup> )		<input type="checkbox"/>	<input type="checkbox"/>		<input type="checkbox"/>
Temperature verification/adjustment <sup>1)</sup>		<input type="checkbox"/>	<input type="checkbox"/>		<input type="checkbox"/>
Verification of operating parameters acc. to specifications					<input type="checkbox"/> <sup>3)</sup>
<b>Documentation</b>					
Check List provided	<input type="checkbox"/>	<input type="checkbox"/>	<input type="checkbox"/>		
Dated service sticker to confirm Eppendorf service	<input type="checkbox"/>	<input type="checkbox"/>	<input type="checkbox"/>	<input type="checkbox"/>	<input type="checkbox"/>
IQ Report and Certificate				<input type="checkbox"/>	
OQ Report and Certificate					<input type="checkbox"/>
<b>Supporting Information</b>					
Contract period	one year	one year	one year	n/a	n/a
Number of preventive services included	one	one	one	n/a	n/a
Cost of repairs /parts replacement outside scope of preventive maintenance visit (where Eppendorf product warranty has expired)	not included	not included	discount on parts, labor, travel time <sup>2)</sup>	n/a	n/a

### Order Numbers for combined Installation and Operational Qualification (IQ/OQ) services:

- > For Eppendorf BioPhotometer®: 0082 110.009
- > For Eppendorf BioSpectrometer®: 0082 110.019

### Order Numbers for additional services:

- > Photometer test for Eppendorf BioPhotometer: 6132 005.026
- > Photometer test for Eppendorf BioSpectrometer: 6135 005.027
- > Photometer test for Eppendorf BioSpectrometer fluorescence: 6137 005.008
- > Temperature verification for Eppendorf BioSpectrometer kinetic: 6136 005.004

<sup>1)</sup> Where feature is present. <sup>2)</sup> Please contact your local Eppendorf Service representative for details on discount and/or any potential additional charges applying. <sup>3)</sup> The detailed certification service contents are listed in the OQ Report.

# Cell Manipulation Performance Plans



### Cell Manipulation Performance Plans

From our knowledgeable Sales and Field Application Specialists to our trained Customer Service and Technical Service Group, our entire team demonstrates a passion for helping you achieve success with your cell manipulation work. Our combination of excellent products and service will prepare you for optimal performance.

With our Performance Plans options we will ensure that your instruments are in good working condition by professional inspection and maintenance service including the exchange of parts due to wear and tear.

Installation and Operational Qualification (IQ/OQ) services assure that your Eppendorf cell manipulation instruments are delivered, installed, and consistently operating at peak performance to manufacturer specifications. IQ/OQ certification can support documentation for your Quality Management System.

### Value of service

- > Reliable system operation at peak performance over the total lifetime of the system
- > GLP supporting documentation

### Precise and accurate instruments will further improve your Cell Manipulation success!

**eppendorf**

Performance tested on

Model: \_\_\_\_\_

Serial no.: \_\_\_\_\_

Serviced by: \_\_\_\_\_

Service no.: \_\_\_\_\_

Next service: \_\_\_\_\_

Date: \_\_\_\_\_

**epServices**  
for premium performance

For more information go to [www.eppendorf.com/epServices](http://www.eppendorf.com/epServices). Performance Plans are available in selected countries only and service offer may differ.



Service Operation	ESSENTIAL CHECK	ADVANCED MAINTENANCE	PREMIUM SERVICE	Installation Qualification (IQ)	Operational Qualification (OQ)
<b>Order Number for Electroporators</b>	0082 010.003	0082 010.004	0082 010.005	0082 010.007	0082 010.008
<b>Order Number for Microinjectors/Micromanipulators</b>	0082 010.013	0082 010.014	0082 010.015	0082 010.017	0082 010.018
<b>External Checks and Maintenance</b>					
Cleaning of housing	<input type="checkbox"/>	<input type="checkbox"/>	<input type="checkbox"/>		
Checking of keyboard		<input type="checkbox"/>	<input type="checkbox"/>		<input type="checkbox"/>
Visual inspection of display		<input type="checkbox"/>	<input type="checkbox"/>		<input type="checkbox"/>
Stability test	<input type="checkbox"/>	<input type="checkbox"/>	<input type="checkbox"/>		
<b>Internal Equipment and Fittings</b>					
Cleaning of internal assemblies		<input type="checkbox"/>	<input type="checkbox"/>		
Leak-tightness test (CellTram®/FemtoJet®)	<input type="checkbox"/>	<input type="checkbox"/>	<input type="checkbox"/>		<input type="checkbox"/>
Oil exchange (CellTram® Oil/vario)	<input type="checkbox"/>	<input type="checkbox"/>	<input type="checkbox"/>		
Inspection of contacts (Electroporator)		<input type="checkbox"/>	<input type="checkbox"/>		<input type="checkbox"/>
Software upgrade		<input type="checkbox"/>	<input type="checkbox"/>		
<b>Functional check</b>					
Check of delivery				<input type="checkbox"/>	
Instrument set-up and initial operation				<input type="checkbox"/>	
Instruction of user				<input type="checkbox"/>	
Motor module test (Micromanipulator)	<input type="checkbox"/>	<input type="checkbox"/>	<input type="checkbox"/>		<input type="checkbox"/>
System test	<input type="checkbox"/>	<input type="checkbox"/>	<input type="checkbox"/>		<input type="checkbox"/>
<b>Memory</b>					
Analysis of error statistics	<input type="checkbox"/>	<input type="checkbox"/>	<input type="checkbox"/>		<input type="checkbox"/>
<b>Documentation</b>					
Check List provided	<input type="checkbox"/>	<input type="checkbox"/>	<input type="checkbox"/>		
Dated service sticker to confirm Eppendorf service	<input type="checkbox"/>	<input type="checkbox"/>	<input type="checkbox"/>	<input type="checkbox"/>	<input type="checkbox"/>
IQ Report and Certificate				<input type="checkbox"/>	
OQ Report and Certificate					<input type="checkbox"/>
<b>Supporting Information</b>					
Contract period	one year	one year	one year	N/A	N/A
Number of preventive services included	one	one	one	N/A	N/A
Costs of repairs/parts replacement outside scope of preventive maintenance visit (where Eppendorf product warranty has expired)	not included	not included	discount on parts labor, travel time <sup>1)</sup>	N/A	N/A

### Order Numbers for combined Installation and Operational Qualification (IQ/OQ) services:

- > for Electroporators: 0082 010.009
- > for Microinjectors/Micromanipulators: 0082 010.019
- > Eppendorf PiezoXpert Actuator Verification: 5194 075.016

Additionally, if you require a Customized Service we will be very pleased to discuss your requirements.

<sup>1)</sup> Please contact your local Eppendorf Service representative for details of discounts and/or any potential additional charges applying.

# CO<sub>2</sub> Incubator Performance Plans



### CO<sub>2</sub> Incubator Performance Plans

CO<sub>2</sub> incubators are the pivotal instruments in cell culture labs. They feature complex, dynamic control systems to maintain user-defined culturing parameters. Accurate measurement and control feedback of multiple environmental variables are necessary in order that cell growth and proliferation is optimized, at the same time minimizing intercellular variation in physiology, metabolic function and expression.

CO<sub>2</sub> Incubator Performance Plan components include a choice of preventive maintenance protocols designed to check, validate and to promote continuous and stable incubator performance, optimizing instrument conformity with programmed culturing parameters. Installation Qualification (IQ) and Operational Qualification (OQ) certification services support your Quality Management requirements by providing you with qualified assurance that your CO<sub>2</sub> incubator is functioning correctly, in accordance with manufacturer specifications.

### Value of service

- > Reliable results over an extended period of time
- > Improves consistency of culturing

### Our service culture for peace of mind!



For more information go to [www.eppendorf.com/epServices](http://www.eppendorf.com/epServices). Performance Plans are available in selected countries only and service offer may differ.



Service Operation	ESSENTIAL CHECK	ADVANCED MAINTENANCE	PREMIUM SERVICE	Installation Qualification (IQ)	Operational Qualification (OQ)
<b>Order Number</b>	0082 060.003	0082 060.004	0082 060.005	0082 060.007	0082 060.008
<b>External Checks and Maintenance</b>					
Check installation environment	<input type="checkbox"/>	<input type="checkbox"/>	<input type="checkbox"/>	<input type="checkbox"/>	<input type="checkbox"/>
Check electrical/gas supply and fittings	<input type="checkbox"/>	<input type="checkbox"/>	<input type="checkbox"/>	<input type="checkbox"/>	<input type="checkbox"/>
Replace in-line gas filter(s) and auto-zero filter	<input type="checkbox"/>	<input type="checkbox"/>	<input type="checkbox"/>	<input type="checkbox"/>	<input type="checkbox"/>
Check door seals and door hinges	<input type="checkbox"/>	<input type="checkbox"/>	<input type="checkbox"/>	<input type="checkbox"/>	<input type="checkbox"/>
<b>Internal Equipment and Fittings</b>					
Check condition of all chamber gas, temperature, humidity sensors	<input type="checkbox"/>	<input type="checkbox"/>	<input type="checkbox"/>	<input type="checkbox"/>	<input type="checkbox"/>
Check security of incubator shelf/shelves and racking system	<input type="checkbox"/>	<input type="checkbox"/>	<input type="checkbox"/>	<input type="checkbox"/>	<input type="checkbox"/>
Check sensor covers are present and undamaged	<input type="checkbox"/>	<input type="checkbox"/>	<input type="checkbox"/>	<input type="checkbox"/>	<input type="checkbox"/>
Check condition of humidity trays	<input type="checkbox"/>	<input type="checkbox"/>	<input type="checkbox"/>	<input type="checkbox"/>	<input type="checkbox"/>
Check condition of wiring system, PCB's, display and controller	<input type="checkbox"/>	<input type="checkbox"/>	<input type="checkbox"/>	<input type="checkbox"/>	<input type="checkbox"/>
Check alarms functionality	<input type="checkbox"/>	<input type="checkbox"/>	<input type="checkbox"/>	<input type="checkbox"/>	<input type="checkbox"/>
<b>Validation and Metrology</b>					
Validation and adjustment of operating parameters to within Eppendorf specifications	<input type="checkbox"/>	<input type="checkbox"/>	<input type="checkbox"/>	<input type="checkbox"/>	<input type="checkbox"/> <sup>2)</sup>
<b>Documentation</b>					
Check List provided	<input type="checkbox"/>	<input type="checkbox"/>	<input type="checkbox"/>	<input type="checkbox"/>	<input type="checkbox"/>
Dated service sticker to confirm Eppendorf service	<input type="checkbox"/>	<input type="checkbox"/>	<input type="checkbox"/>	<input type="checkbox"/>	<input type="checkbox"/>
IQ Report and Certificate	<input type="checkbox"/>	<input type="checkbox"/>	<input type="checkbox"/>	<input type="checkbox"/>	<input type="checkbox"/>
OQ Report and Certificate	<input type="checkbox"/>	<input type="checkbox"/>	<input type="checkbox"/>	<input type="checkbox"/>	<input type="checkbox"/>
<b>Supporting Information</b>					
Contract period	one year	one year	one year	n/a	n/a
Number of preventive services included	one	one	one	n/a	n/a
Cost of repairs/parts replacement outside scope of preventive maintenance visit (where Eppendorf product warranty has expired)	not included	not included	discount on parts, labor and travel time <sup>1)</sup>	n/a	n/a

**Order Number for combined Installation and Operational Qualification (IQ/OQ) services: 0082 060.009. Additionally, if you require a Customized Service we will be very pleased to discuss your requirements.**

<sup>1)</sup> Please contact your local Eppendorf Service representative for details of discounts and/or any potential additional charges applying.  
<sup>2)</sup> The detailed certification service contents are listed in the OQ Report: e.g. verification of temperature, CO<sub>2</sub>, speed, alarm, and final test run.

# Biological Shaker Performance Plans



### Biological Shaker Performance Plans

Biological shakers are essential to cell culture applications and are required to be in continuous use for years. Relatively small, short-term variations in shaker operation can significantly influence culturing outcomes, with negative effects on yields and/or cell expression. Eppendorf's Biological Shaker Performance Plans ensure consistent, reliable shaker performance meeting manufacturer specifications.

Biological Shaker Performance Plans include a choice of preventive maintenance protocols which are designed to check and validate stable shaker performance.

Installation Qualification (IQ) and Operational Qualification (OQ) certification services support your Quality Management requirements by providing you with qualified assurance that your biological shaker is functioning correctly, in accordance with manufacturer specifications.

### Value of service

- > Improves reliability and consistency
- > Long lifetime of instruments

### Care for your shaker – optimize your cultures!

**eppendorf**

Performance tested on

Model: \_\_\_\_\_

Serial no.: \_\_\_\_\_

Serviced by: \_\_\_\_\_

Service no.: \_\_\_\_\_

Next service: \_\_\_\_\_

Date: \_\_\_\_\_

**epServices**  
for premium performance

For more information go to [www.eppendorf.com/epServices](http://www.eppendorf.com/epServices). Performance Plans are available in selected countries only and service offer may differ.



Service Operation	ESSENTIAL CHECK	ADVANCED MAINTENANCE	PREMIUM SERVICE	Installation Qualification (IQ)	Operational Qualification (OQ)
<b>Order Number for Shakers with Heating/Cooling</b>	0082 080.003	0082 080.004	0082 080.005	0082 080.007	0082 080.008
<b>Order Number for OpenAir Shakers</b>	0082 080.013	0082 080.014	0082 080.015	0082 080.017	0082 080.018
<b>Order Number for Shakers with Heating</b>	0082 080.023	0082 080.024	0082 080.025	0082 080.027	0082 080.028
<b>Order Number for Shaker S44i</b>	0082 080.213	0082 080.214	0082 080.215	0082 080.217	0082 080.218
<b>Order Number for Industrial Shakers</b>	0082 080.033	0082 080.034	0082 080.035	0082 080.037	0082 080.038
<b>External Checks and Maintenance</b>					
Check installation environment	■	■	■	■	■
Check electrical/gas <sup>1)</sup> supply and fittings		■	■	■	■
Check condition/operation of any door/lid open sensors		■	■	■	■
Check security of doors/lids, handles, door struts <sup>1)</sup> and hinges		■	■	■	■
<b>Internal Equipment and Fittings</b>					
Check security of shaker mechanism; lubricate non-sealed bearings, as appropriate <sup>1)</sup>		■	■		
Check shaker drive motor, and circulation fan <sup>1)</sup>		■	■		■
Check condition of shaker drive belt; adjust belt tension as necessary		■	■		
Clean and check condenser <sup>1)</sup>		■	■		
<b>Validation and Metrology</b>					
Validation and adjustment of operating parameters to within Eppendorf specifications	■	■	■		■ <sup>3)</sup>
<b>Documentation</b>					
Check List provided	■	■	■		
Dated service sticker to confirm Eppendorf service	■	■	■	■	■
IQ Report and Certificate				■	
OQ Report and Certificate					■
<b>Supporting Information</b>					
Contract period	one year	one year	one year	n/a	n/a
Number of preventive services included	one	one	one	n/a	n/a
Cost of repairs/parts replacement outside scope of preventive maintenance visit (where Eppendorf product warranty has expired)	not included	not included	discount on parts, labor, travel time <sup>2)</sup>	n/a	n/a

### Order Numbers for combined Installation and Operational Qualification (IQ/OQ) services:

- > for open shaker: **0082 080.019**
- > for shaker with heating: **0082 080.029**
- > for shaker with heating/cooling: **0082 080.009**
- > for shaker S44i: **0082 080.219**
- > for industrial shaker: **0082 080.039**

**Additionally, if you require a Customized Service we will be very pleased to discuss your requirements.**

<sup>1)</sup> Where feature is present. <sup>2)</sup> Please contact your local Eppendorf Service representative for details of discounts and/or any potential additional charges applying.

<sup>3)</sup> The detailed certification service contents are listed in the OQ Report: e.g. verification of rpm, temperature, alarms, and final test run.



# S41i Incubator Shaker Performance Plans



### S41i Incubator Shaker Performance Plans

The versatility of the New Brunswick S41i Incubator Shaker supports simultaneous culture of adherent and suspension cultures. The smallest deviations in the culturing environment can result in undesirable outcomes. To ensure reproducible results and to protect your precious cultures from undesirable variables, we offer a range of maintenance services.

For your Quality Management requirements we also offer certification services that include Installation Qualification (IQ) and Operational Qualification (OQ) certification to provide optimal instrument performance, stability and accuracy of culturing parameters, in accordance with manufacturer specifications.

### Value of service

- > Reliable system performance and culturing results over the entire system lifetime
- > GLP supporting documentation

### Optimized system - reliable results!



For more information go to [www.eppendorf.com/epServices](http://www.eppendorf.com/epServices). Performance Plans are available in selected countries only and service offer may differ.



Service Operation	ESSENTIAL CHECK	ADVANCED MAINTENANCE	PREMIUM SERVICE	Installation Qualification (IQ)	Operational Qualification (OQ)
<b>Order Number</b>	0082 050.003	0082 050.004	0082 050.005	0082 050.007	0082 050.008
<b>External Checks and Maintenance</b>					
Check installation environment	■	■	■	■	■
Check electrical/gas supply and fittings		■	■	■	■
Replace in-line CO <sub>2</sub> filter and auto-zero filter		■	■		
<b>Internal Equipment and Fittings</b>					
Check security of shaker platform(s) and flask holders		■	■	■	■
Check security of incubator shelf/shelves and racking system		■	■	■	■
Replace platform support post boot seals		■	■		
Check condition of humidity trays		■	■		
Check condition of shaker drive belt		■	■		
Check condition of chamber CO <sub>2</sub> and temperature sensors	■	■	■		■
<b>Validation and Metrology</b>					
Validation and adjustment of operating parameters to within Eppendorf specifications	■	■	■		■ <sup>2)</sup>
<b>Documentation</b>					
Check List provided	■	■	■		
Dated service sticker to confirm Eppendorf service	■	■	■	■	■
IQ Report and Certificate				■	
OQ Report and Certificate					■
<b>Supporting Information</b>					
Contract period	one year	one year	one year	n/a	n/a
Number of preventive services included	one	one	one	n/a	n/a
Cost of repairs/parts replacement outside scope of preventive maintenance visit (where Eppendorf product warranty has expired)	not included	not included	discount on parts, labor and travel time <sup>1)</sup>	n/a	n/a

**Order number for combined Installation and Operational Qualification (IQ/OQ) services: 0082 050.009. Additionally, if you require a Customized Service we will be very pleased to discuss your requirements.**

<sup>1)</sup> Please contact your local Eppendorf Service representative for details of discounts and/or any potential additional charges applying.  
<sup>2)</sup> The detailed certification service contents are listed in the OQ Report: e.g. verification of temperature, CO<sub>2</sub>, speed, alarm and final test run.



# Bioprocess Performance Plans

## Bioprocess Performance Plans

Bioprocess systems include several sophisticated technologies. Peak performance requires smooth interplay of the subsystems and fully functioning consumable parts. Regular maintenance by qualified engineers helps to ensure reliable operation, while deferring it can cause unreliable results, expensive repairs, and prolonged downtime. Eppendorf Bioprocess Performance Plans help you to maintain the optimal performance of your equipment over years of frequent use.



You will find details and ordering information for all bioprocess performance plans in the Bioprocess Catalog 2018!



[www.eppendorf.com/catalog](http://www.eppendorf.com/catalog)

# We support your work in regulated laboratories!

Eppendorf offers a range of products in two versions: as General Lab Products (front section of this catalog) and as regulated products which are presented in the following section. Here you find products supporting your regulated applications, i.e. EU in-vitro diagnostic (IVD) products according to 98/79/EC and EU Medical Devices (MD) according to 93/42/EEC.

All products follow the same extremely high quality standards at Eppendorf. We are not making any compromises when it comes to precision, accuracy, robustness, safety and ergonomics.

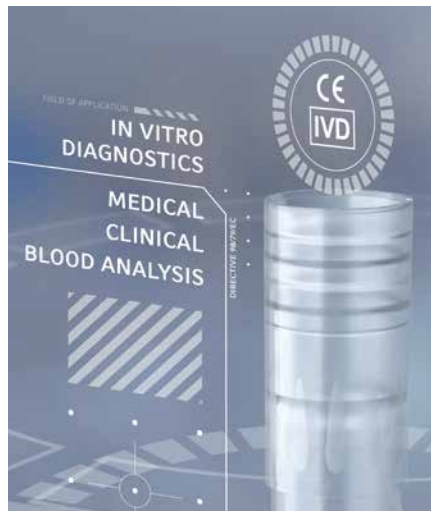

## EU-IVD products:

If your lab work is focused on diagnostic applications an IVD compliant product can add peace of mind to support your documentation and accreditation requirements. Eppendorf has taken all the measurements needed to make sure the IVD compliant documentation according to the IVD directive 98/79/EC is fulfilled and furthermore CE certificates are provided.



## EU-Medical Devices:

If the work performed in your laboratory falls into the scope of the Medical Device Directive 93/42/EEC you depend on accordingly equipment.

Our In-vitro fertilization (IVF) equipment has been designed for intuitive operation and optimal performance for a variety of applications in human reproductive medicine.

## Your Global Supplier for Products and Solutions

### Description

Customized Solutions products are Eppendorf products that have been tailored to the individual requirements of major customers. The Customized Eppendorf Automation Tips can be found offering solutions to requirements, such as:

- > Conductive
- > Non-conductive
- > Special tray colors
- > Dimensions
- > Materials
- > Packaging
- > Alternative labeling

For increased convenience printing your company name and identification of products on plates can be easily carried out.

Our OEM portfolio offers further options such as:

- > Special purity degree: "customized clean".

**The flexibility of Eppendorf OEM/Customized Solutions options are designed to fit your highest demands. Examples of customized items:**

- > Modified packaging
- > Customized designs or logos



### OEM Products

- > Innovative Technology
- > Cutting-Edge Development
- > Highest Quality Standard
- > Eppendorf manufactured



[www.eppendorf.com/oem-video](http://www.eppendorf.com/oem-video)



[www.eppendorf.com/oem-brochure](http://www.eppendorf.com/oem-brochure)

For more information go to [www.eppendorf.com/OEM](http://www.eppendorf.com/OEM)

OEM-components/products are sold exclusively to companies who sell these goods on to third parties in conjunction with their own products or as a component of their kits. Technical specifications subject to change.

OEM-components/products are sold exclusively to companies who sell these goods on to third parties in conjunction with their own products or as a component of their kits. Technical specifications subject to change.

## Customized Liquid Handling Robots and Cyclers

### Description

A selection of Eppendorf instruments for OEM opportunities is the epMotion®, Eppendorfs own developed and manufactured Liquid Handling Workstation.

The range of Eppendorf automated workstations provides an open OEM platform for many Liquid Handling applications by:

- > Flexibility of positions
- > Technology of magnetic separation
- > GxP software

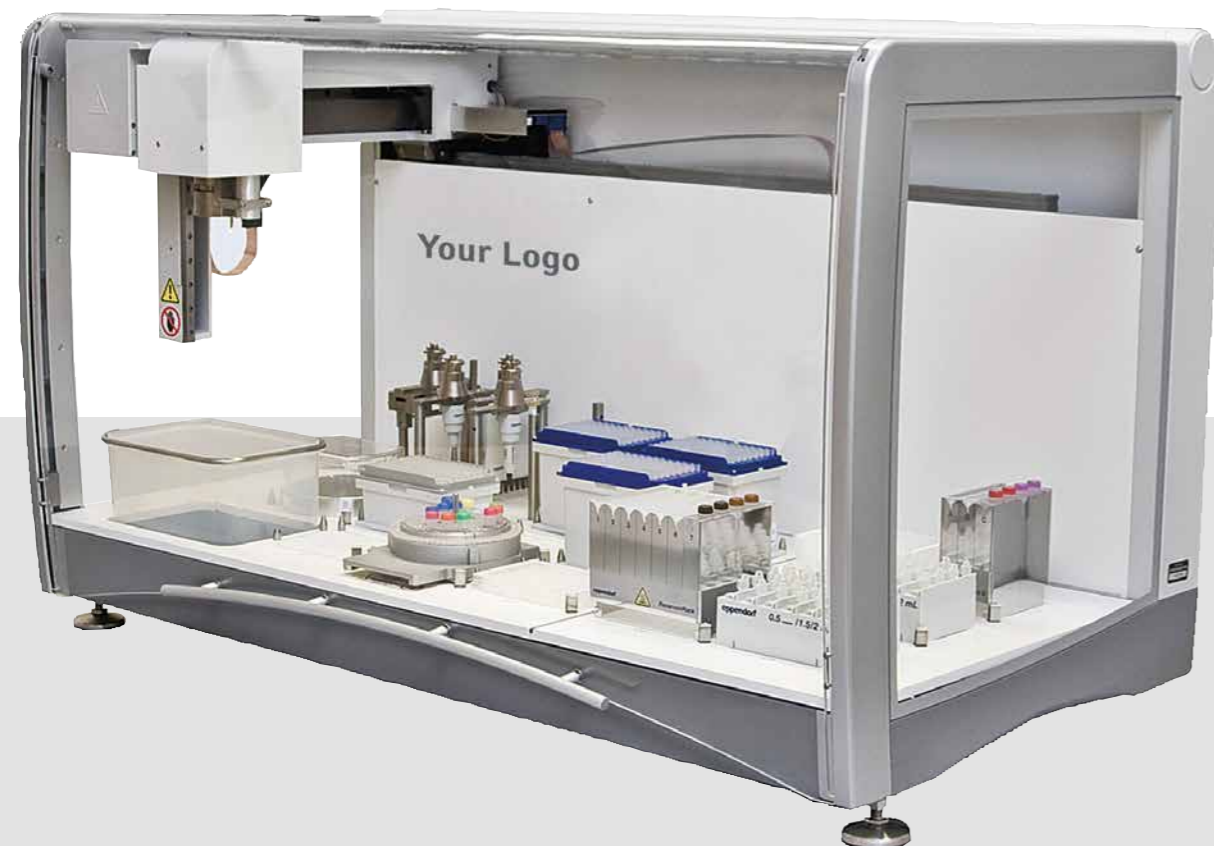

We offer OEM PCR cyclers for a range of applications including diagnostic use:

- > Silver or aluminum block
- > With or without gradient function
- > Flexlid for a wide range of consumables

Customization according to your needs is our business!



Have a look on our website!



[www.eppendorf.com/oem](http://www.eppendorf.com/oem)

For more information go to [www.eppendorf.com/OEM](http://www.eppendorf.com/OEM)

OEM-components/products are sold exclusively to companies who sell these goods on to third parties in conjunction with their own products or as a component of their kits. Technical specifications subject to change.

OEM-components/products are sold exclusively to companies who sell these goods on to third parties in conjunction with their own products or as a component of their kits. Technical specifications subject to change.



## Eppendorf Reference® 2



\* The Reference® 2 pipette is designed and constructed for low-contamination transfer of liquids, in particular for samples from the human body and for reagents within the scope of an in-vitro diagnostic application in order to allow the in-vitro diagnostic medical device to be used as intended. This pipette is an in-vitro diagnostic device according to Directive 98/79/EC of the European Parliament and the Council dated October 27, 1998. It is intended exclusively for indoor use and for operation by qualified staff.



## Ordering information

Volume range	Color code	Rel. systematic error <sup>1)</sup>	Abs. systematic error <sup>1)</sup>	Rel. random error <sup>1)</sup>	Abs. random error <sup>1)</sup>	Order no.
<b>Eppendorf Reference® 2, single-channel, fixed</b>						
1 µL	dark gray	±2.5 %	±0.025 µL	±1.8 %	±0.018 µL	4921 000.010
2 µL	dark gray	±2.0 %	±0.04 µL	±1.2 %	±0.024 µL	4921 000.028
5 µL	medium gray	±1.2 %	±0.06 µL	±0.6 %	±0.03 µL	4921 000.036
10 µL	medium gray	±1.0 %	±0.1 µL	±0.5 %	±0.05 µL	4921 000.044
10 µL	yellow	±1.2 %	±0.12 µL	±0.5 %	±0.05 µL	4921 000.052
20 µL	light gray	±0.8 %	±0.16 µL	±0.3 %	±0.06 µL	4921 000.060
20 µL	yellow	±1.0 %	±0.2 µL	±0.3 %	±0.06 µL	4921 000.079
25 µL	yellow	±1.0 %	±0.25 µL	±0.3 %	±0.075 µL	4921 000.087
50 µL	yellow	±0.7 %	±0.35 µL	±0.3 %	±0.15 µL	4921 000.095
100 µL	yellow	±0.6 %	±0.6 µL	±0.2 %	±0.2 µL	4921 000.109
200 µL	yellow	±0.6 %	±1.2 µL	±0.2 %	±0.4 µL	4921 000.117
200 µL	blue	±0.6 %	±1.2 µL	±0.2 %	±0.4 µL	4921 000.125
250 µL	blue	±0.6 %	±1.5 µL	±0.2 %	±0.5 µL	4921 000.133
500 µL	blue	±0.6 %	±3.0 µL	±0.2 %	±1.0 µL	4921 000.141
1,000 µL	blue	±0.6 %	±6.0 µL	±0.2 %	±2.0 µL	4921 000.150
2 mL	red	±0.6 %	±0.012 mL	±0.2 %	±0.004 mL	4921 000.168
2.5 mL	red	±0.6 %	±0.015 mL	±0.2 %	±0.005 mL	4921 000.176

<sup>1)</sup> The error data, according to EN ISO 8655, only apply if original Eppendorf tips are used. Technical specifications are subject to change. Errors and omissions excepted.

## Ordering information

Description	Order no.
<b>Eppendorf Reference® 2, 3-pack</b> , single-channel, variable, incl. epT.I.P.S.® Box or sample bag and ballpoint pen	
<b>Option 1:</b> 0.5 – 10 µL, 10 – 100 µL, 100 – 1,000 µL	4920 000.903
<b>Option 2:</b> 2 – 20 µL yellow, 20 – 200 µL, 100 – 1,000 µL	4920 000.911
<b>Option 3:</b> 100 – 1,000 µL, 0.5 – 5 mL, 1 – 10 mL	4920 000.920

► Pipette service and maintenance contracts can be found on page 358.



## Ordering information

Volume range	Color code	Volume	Rel. systematic error <sup>1)</sup>	Abs. systematic error <sup>1)</sup>	Rel. random error <sup>1)</sup>	Abs. random error <sup>1)</sup>	Order no.
<b>Eppendorf Reference® 2, single-channel, variable, incl. epT.I.P.S.® Box</b>							
0.1 – 2.5 µL	dark gray	0.1 µL	±48.0 %	±0.048 µL	±12.0 %	±0.012 µL	4920 000.016
		0.25 µL	±12.0 %	±0.03 µL	±6.0 %	±0.015 µL	
		1.25 µL	±2.5 %	±0.031 µL	±1.5 %	±0.019 µL	
		2.5 µL	±1.4 %	±0.035 µL	±0.7 %	±0.018 µL	
0.5 – 10 µL	medium gray	0.5 µL	±8.0 %	±0.04 µL	±5.0 %	±0.025 µL	4920 000.024
		1.0 µL	±2.5 %	±0.025 µL	±1.8 %	±0.018 µL	
		5.0 µL	±1.5 %	±0.075 µL	±0.8 %	±0.04 µL	
		10 µL	±1.0 %	±0.10 µL	±0.4 %	±0.04 µL	
2 – 20 µL	light gray	2.0 µL	±3.0 %	±0.06 µL	±1.5 %	±0.03 µL	4920 000.032
		10 µL	±1.0 %	±0.10 µL	±0.6 %	±0.06 µL	
		20 µL	±0.8 %	±0.16 µL	±0.3 %	±0.06 µL	
2 – 20 µL	yellow	2.0 µL	±5.0 %	±0.10 µL	±1.5 %	±0.03 µL	4920 000.040
		10 µL	±1.2 %	±0.12 µL	±0.6 %	±0.06 µL	
		20 µL	±1.0 %	±0.2 µL	±0.3 %	±0.06 µL	
10 – 100 µL	yellow	10 µL	±3.0 %	±0.3 µL	±0.7 %	±0.07 µL	4920 000.059
		50 µL	±1.0 %	±0.5 µL	±0.3 %	±0.15 µL	
		100 µL	±0.8 %	±0.8 µL	±0.2 %	±0.2 µL	
20 – 200 µL	yellow	20 µL	±2.5 %	±0.5 µL	±0.7 %	±0.14 µL	4920 000.067
		100 µL	±1.0 %	±1.0 µL	±0.3 %	±0.3 µL	
		200 µL	±0.6 %	±1.2 µL	±0.2 %	±0.4 µL	
30 – 300 µL	orange	30 µL	±2.5 %	±0.75 µL	±0.7 %	±0.21 µL	4920 000.075
		150 µL	±1.0 %	±1.5 µL	±0.3 %	±0.45 µL	
		300 µL	±0.6 %	±1.8 µL	±0.2 %	±0.6 µL	
100 – 1,000 µL	blue	100 µL	±3.0 %	±3.0 µL	±0.6 %	±0.6 µL	4920 000.083
		500 µL	±1.0 %	±5.0 µL	±0.2 %	±1.0 µL	
		1,000 µL	±0.6 %	±6.0 µL	±0.2 %	±2.0 µL	

## Eppendorf Reference® 2, single-channel, variable, incl. epT.I.P.S.® sample bag

0.25 – 2.5 mL	red	0.25 mL	±4.8 %	±0.012 mL	±1.2 %	±0.003 mL	4920 000.091
		1.25 mL	±0.8 %	±0.010 mL	±0.2 %	±0.0025 mL	
		2.5 mL	±0.6 %	±0.015 mL	±0.2 %	±0.005 mL	
0.5 – 5 mL	violet	0.5 mL	±2.4 %	±0.012 mL	±0.6 %	±0.003 mL	4920 000.105
		2.5 mL	±1.2 %	±0.030 mL	±0.25 %	±0.006 mL	
		5.0 mL	±0.6 %	±0.030 mL	±0.15 %	±0.0075 mL	
1 – 10 mL	turquoise	1.0 mL	±3.0 %	±0.030 mL	±0.6 %	±0.006 mL	4920 000.113
		5.0 mL	±0.8 %	±0.040 mL	±0.2 %	±0.010 mL	
		10.0 mL	±0.6 %	±0.060 mL	±0.15 %	±0.015 mL	

<sup>1)</sup> The error data, according to EN ISO 8655, only apply if original Eppendorf tips are used. Technical specifications are subject to change. Errors and omissions excepted.

## Ordering information

Volume range	Color code	Volume	Rel. systematic error <sup>1)</sup>	Abs. systematic error <sup>1)</sup>	Rel. random error <sup>1)</sup>	Abs. random error <sup>1)</sup>	Order no.
<b>Eppendorf Reference® 2, 8-channel, variable, incl. epT.I.P.S.® Box</b>							
0.5 – 10 µL	medium gray	0.5 µL	±12.0 %	±0.06 µL	±8.0 %	±0.04 µL	4922 000.013
		1.0 µL	±8.0 %	±0.08 µL	±5.0 %	±0.05 µL	
		5.0 µL	±4.0 %	±0.2 µL	±2.0 %	±0.1 µL	
		10 µL	±2.0 %	±0.2 µL	±1.0 %	±0.1 µL	
10 – 100 µL	yellow	10 µL	±3.0 %	±0.3 µL	±2.0 %	±0.2 µL	4922 000.030
		50 µL	±1.0 %	±0.5 µL	±0.8 %	±0.4 µL	
		100 µL	±0.8 %	±0.8 µL	±0.3 %	±0.3 µL	
30 – 300 µL	orange	30 µL	±3.0 %	±0.9 µL	±1.0 %	±0.3 µL	4922 000.056
		150 µL	±1.0 %	±1.5 µL	±0.5 %	±0.75 µL	
		300 µL	±0.6 %	±1.8 µL	±0.3 %	±0.9 µL	
<b>Eppendorf Reference® 2, 12-channel, variable, incl. epT.I.P.S.® Box</b>							
0.5 – 10 µL	medium gray	0.5 µL	±12.0 %	±0.06 µL	±8.0 %	±0.04 µL	4922 000.021
		1.0 µL	±8.0 %	±0.08 µL	±5.0 %	±0.05 µL	
		5.0 µL	±4.0 %	±0.2 µL	±2.0 %	±0.1 µL	
		10 µL	±2.0 %	±0.2 µL	±1.0 %	±0.1 µL	
10 – 100 µL	yellow	10 µL	±3.0 %	±0.3 µL	±2.0 %	±0.2 µL	4922 000.048
		50 µL	±1.0 %	±0.5 µL	±0.8 %	±0.4 µL	
		100 µL	±0.8 %	±0.8 µL	±0.3 %	±0.3 µL	
30 – 300 µL	orange	30 µL	±3.0 %	±0.9 µL	±1.0 %	±0.3 µL	4922 000.064
		150 µL	±1.0 %	±1.5 µL	±0.5 %	±0.75 µL	
		300 µL	±0.6 %	±1.8 µL	±0.3 %	±0.9 µL	

<sup>1)</sup> The error data, according to EN ISO 8655, only apply if original Eppendorf tips are used. Technical specifications are subject to change. Errors and omissions excepted.



## Eppendorf Research® plus



\* The Research® plus pipette is designed and constructed for low-contamination transfer of liquids, in particular for samples from the human body and for reagents within the scope of an in-vitro diagnostic application in order to allow the in-vitro diagnostic medical device to be used as intended. This pipette is an in-vitro diagnostic device according to Directive 98/79/EC of the European Parliament and the Council dated October 27, 1998. It is intended exclusively for indoor use and for operation by qualified staff.



## Ordering information

Volume range	Color code	Rel. systematic error <sup>1)</sup>	Abs. systematic error <sup>1)</sup>	Rel. random error <sup>1)</sup>	Abs. random error <sup>1)</sup>	Order no.
<b>Eppendorf Research® plus, single-channel, fixed</b>						
10 µL	medium gray	±1.2 %	±0.12 µL	±0.6 %	±0.06 µL	3121 000.015
10 µL	yellow	±1.2 %	±0.12 µL	±0.6 %	±0.06 µL	3121 000.023
20 µL	light gray	±0.8 %	±0.16 µL	±0.3 %	±0.06 µL	3121 000.031
20 µL	yellow	±1.0 %	±0.2 µL	±0.3 %	±0.06 µL	3121 000.040
25 µL	yellow	±1.0 %	±0.25 µL	±0.3 %	±0.08 µL	3121 000.058
50 µL	yellow	±0.7 %	±0.35 µL	±0.3 %	±0.15 µL	3121 000.066
100 µL	yellow	±0.6 %	±0.6 µL	±0.2 %	±0.2 µL	3121 000.074
200 µL	yellow	±0.6 %	±1.2 µL	±0.2 %	±0.4 µL	3121 000.082
200 µL	blue	±0.6 %	±1.2 µL	±0.2 %	±0.4 µL	3121 000.090
250 µL	blue	±0.6 %	±1.5 µL	±0.2 %	±0.5 µL	3121 000.104
500 µL	blue	±0.6 %	±3.0 µL	±0.2 %	±1.0 µL	3121 000.112
1,000 µL	blue	±0.6 %	±6.0 µL	±0.2 %	±2.0 µL	3121 000.120

<sup>1)</sup> The error data, according to EN ISO 8655, only apply if original Eppendorf tips are used. Technical specifications are subject to change. Errors and omissions excepted.

## Ordering information

Description	Order no.
<b>Eppendorf Research® plus 3-pack</b> , single-channel, variable, incl. epT.I.P.S.® Box or sample bag and ballpoint pen	
<b>Option 1:</b> 0.5 – 10 µL, 10 – 100 µL, 100 – 1,000 µL	3122 000.909
<b>Option 2:</b> 2 – 20 µL yellow, 20 – 200 µL, 100 – 1,000 µL	3122 000.917
<b>Option 3:</b> 100 – 1,000 µL, 0.5 – 5 mL, 1 – 10 mL	3122 000.925

► Pipette service and maintenance contracts can be found on page 358. Pipette tips can be found on page 38 and 396 onward.

ℹ For more information go to [www.eppendorf.com/Reference2](http://www.eppendorf.com/Reference2)



## Ordering information

Volume range	Color code	Volume	Rel. systematic error <sup>1)</sup>	Abs. systematic error <sup>1)</sup>	Rel. random error <sup>1)</sup>	Abs. random error <sup>1)</sup>	Order no.
<b>Eppendorf Research® plus, single-channel, variable, incl. epT.I.P.S.® Box</b>							
0.1 – 2.5 µL	dark gray	0.1 µL	±48.0 %	±0.048 µL	±12.0 %	±0.012 µL	3120 000.011
		0.25 µL	±12.0 %	±0.03 µL	±6.0 %	±0.015 µL	
		1.25 µL	±2.5 %	±0.031 µL	±1.5 %	±0.019 µL	
		2.5 µL	±1.4 %	±0.035 µL	±0.7 %	±0.018 µL	
0.5 – 10 µL	medium gray	0.5 µL	±8.0 %	±0.04 µL	±5.0 %	±0.025 µL	3120 000.020
		1 µL	±2.5 %	±0.025 µL	±1.8 %	±0.018 µL	
		5 µL	±1.5 %	±0.075 µL	±0.8 %	±0.04 µL	
		10 µL	±1.0 %	±0.1 µL	±0.4 %	±0.04 µL	
2 – 20 µL	light gray	2 µL	±5.0 %	±0.1 µL	±1.5 %	±0.03 µL	3120 000.097
		10 µL	±1.2 %	±0.12 µL	±0.6 %	±0.06 µL	
		20 µL	±1.0 %	±0.2 µL	±0.3 %	±0.06 µL	
2 – 20 µL	yellow	2 µL	±5.0 %	±0.1 µL	±1.5 %	±0.03 µL	3120 000.038
		10 µL	±1.2 %	±0.12 µL	±0.6 %	±0.06 µL	
		20 µL	±1.0 %	±0.2 µL	±0.3 %	±0.06 µL	
10 – 100 µL	yellow	10 µL	±3.0 %	±0.3 µL	±1.0 %	±0.1 µL	3120 000.046
		50 µL	±1.0 %	±0.5 µL	±0.3 %	±0.15 µL	
		100 µL	±0.8 %	±0.8 µL	±0.2 %	±0.2 µL	
20 – 200 µL	yellow	20 µL	±2.5 %	±0.5 µL	±0.7 %	±0.14 µL	3120 000.054
		100 µL	±1.0 %	±1.0 µL	±0.3 %	±0.3 µL	
		200 µL	±0.6 %	±1.2 µL	±0.2 %	±0.4 µL	
30 – 300 µL	orange	30 µL	±2.5 %	±0.75 µL	±0.7 %	±0.21 µL	3120 000.100
		150 µL	±1.0 %	±1.5 µL	±0.3 %	±0.45 µL	
		300 µL	±0.6 %	±1.8 µL	±0.2 %	±0.6 µL	
100 – 1,000 µL	blue	100 µL	±3.0 %	±3.0 µL	±0.6 %	±0.6 µL	3120 000.062
		500 µL	±1.0 %	±5.0 µL	±0.2 %	±1.0 µL	
		1,000 µL	±0.6 %	±6.0 µL	±0.2 %	±2.0 µL	
<b>Eppendorf Research® plus, single-channel, variable, incl. epT.I.P.S.® sample bag</b>							
0.5 – 5 mL	violet	0.5 mL	±2.4 %	±0.012 mL	±0.6 %	±0.003 mL	3120 000.070
		2.5 mL	±1.2 %	±0.03 mL	±0.25 %	±0.006 mL	
		5 mL	±0.6 %	±0.03 mL	±0.15 %	±0.008 mL	
1 – 10 mL	turquoise	1 mL	±3.0 %	±0.03 mL	±0.6 %	±0.006 mL	3120 000.089
		5 mL	±0.8 %	±0.04 mL	±0.2 %	±0.01 mL	
		10 mL	±0.6 %	±0.06 mL	±0.15 %	±0.015 mL	

<sup>1)</sup> The error data, according to EN ISO 8655, only apply if original Eppendorf tips are used. Technical specifications are subject to change. Errors and omissions excepted.

## Ordering information

Volume range	Color code	Volume	Rel. systematic error <sup>1)</sup>	Abs. systematic error <sup>1)</sup>	Rel. random error <sup>1)</sup>	Abs. random error <sup>1)</sup>	Order no.
<b>Eppendorf Research® plus, 8-channel, variable, incl. epT.I.P.S.® Box</b>							
0.5 – 10 µL	medium gray	0.5 µL	±12.0 %	±0.06 µL	±8.0 %	±0.04 µL	3122 000.019
		1 µL	±8.0 %	±0.08 µL	±5.0 %	±0.05 µL	
		5 µL	±4.0 %	±0.2 µL	±2.0 %	±0.1 µL	
		10 µL	±2.0 %	±0.2 µL	±1.0 %	±0.1 µL	
10 – 100 µL	yellow	10 µL	±3.0 %	±0.3 µL	±2.0 %	±0.2 µL	3122 000.035
		50 µL	±1.0 %	±0.5 µL	±0.8 %	±0.4 µL	
		100 µL	±0.8 %	±0.8 µL	±0.3 %	±0.3 µL	
30 – 300 µL	orange	30 µL	±3.0 %	±0.9 µL	±1.0 %	±0.3 µL	3122 000.051
		150 µL	±1.0 %	±1.5 µL	±0.5 %	±0.75 µL	
		300 µL	±0.6 %	±1.8 µL	±0.3 %	±0.9 µL	
<b>Eppendorf Research® plus, 12-channel, variable, incl. epT.I.P.S.® Box</b>							
0.5 – 10 µL	medium gray	0.5 µL	±12.0 %	±0.06 µL	±8.0 %	±0.04 µL	3122 000.027
		1 µL	±8.0 %	±0.08 µL	±5.0 %	±0.05 µL	
		5 µL	±4.0 %	±0.2 µL	±2.0 %	±0.1 µL	
		10 µL	±2.0 %	±0.2 µL	±1.0 %	±0.1 µL	
10 – 100 µL	yellow	10 µL	±3.0 %	±0.3 µL	±2.0 %	±0.2 µL	3122 000.043
		50 µL	±1.0 %	±0.5 µL	±0.8 %	±0.4 µL	
		100 µL	±0.8 %	±0.8 µL	±0.3 %	±0.3 µL	
30 – 300 µL	orange	30 µL	±3.0 %	±0.9 µL	±1.0 %	±0.3 µL	3122 000.060
		150 µL	±1.0 %	±1.5 µL	±0.5 %	±0.75 µL	
		300 µL	±0.6 %	±1.8 µL	±0.3 %	±0.9 µL	

<sup>1)</sup> The error data, according to EN ISO 8655, only apply if original Eppendorf tips are used. Technical specifications are subject to change. Errors and omissions excepted.

# epT.I.P.S.<sup>®</sup>

\* The pipette tips epT.I.P.S.<sup>®</sup> in the packaging units Reloads, Box, Set, Singles and Racks are designed and constructed for low-contamination transfer of liquids, in particular for samples from the human body and for reagents within the scope of an in-vitro diagnostic application in order to allow the in-vitro diagnostic device to be used as intended. The above mentioned epT.I.P.S.<sup>®</sup> are in-vitro diagnostic devices according to Directive 98/79/EC of the European Parliament and the Council dated October 27, 1998. They are intended exclusively for single use and for application by qualified staff.



## Description

For epT.I.P.S. – the original Eppendorf „Totally Integrated Pipetting System“ – the tips are optimally coordinated to Eppendorf pipettes and, of course, meet EN ISO 8655 requirements. This has resulted in minimal attachment and ejection forces with the highest level of tightness. epT.I.P.S. pipette tips can be used with pipettes from other manufacturers. Optimal wetting properties, high transparency and special, certified purity grades are the visible expression of our product and production philosophy.

## Applications

- > Pipetting liquids
- > Dispensing liquids
- > Mixing liquids
- > Filling plates and reaction vessels

## Product features

- > The ergonomically optimized cone geometry provides the optimal pipette fit on the Eppendorf pipette
- > epT.I.P.S. pipette tips can be used universally, including pipette models from other manufacturers
- > Fine graduations make visual checks of the pipetting volume even easier
- > Long, narrow tips reach the base of narrow and high vessels without touching the top of the vessel edge
- > Fine retracted or extended tips simplify work with small volumes
- > Available in purity grades of: Eppendorf Quality, PCR clean, Eppendorf Biopur<sup>®</sup>
- > Color-coded trays make volume identification and allocation of Eppendorf pipettes easier than ever

i For more information go to [www.eppendorf.com/epTips](http://www.eppendorf.com/epTips)

> Ordering information see page 46 and 398

Technical specifications subject to change.



## epT.I.P.S.<sup>®</sup> Box/epT.I.P.S.<sup>®</sup> Set

- > Contamination-free transfer of trays to stable working box
- > System optimized for use with multichannel pipettes
- > Color-coded trays for simple identification of tips and pipette
- > Tips can be attached to pipette from refill trays
- > Boxes and trays are autoclavable
- > epT.I.P.S. Box and epT.I.P.S. Set available in Eppendorf Quality



## epT.I.P.S.<sup>®</sup> Racks

- > Eppendorf Biopur pipette tips offer the highest biological purity grade
- > Guaranteed PCR clean, sterile, pyrogen-, ATP- and DNA-free
- > For use in medical, pharmaceutical and food industry, molecular biology and cell technology
- > Each production lot inspected continuously by independent laboratory
- > Lot-specific certificates available at [www.eppendorf.com/certificates](http://www.eppendorf.com/certificates)
- > Packed in racks with 96, 48 or 24 tips



## epT.I.P.S.<sup>®</sup> Singles

- > Eppendorf Biopur pipette tip, individually wrapped
- > Guaranteed PCR clean, sterile, pyrogen-, ATP- and DNA-free
- > For use in medical, pharmaceutical and food industry, molecular biology and cell technology
- > Batch number and expiration date on each blister package
- > Each production lot inspected continuously by independent laboratory
- > Lot-specific certificates available at [www.eppendorf.com/certificates](http://www.eppendorf.com/certificates)









## epT.I.P.S.<sup>®</sup> Reloads

- > Reduced waste as compared with disposable racks
- > The refill trays can be autoclaved up to 121 °C, in packaging and without foil, for subsequent use
- > The refill system, depending on tips size, is packaged as either dual-sided or in stack form
- > Available in purity grades of Eppendorf Quality and PCR clean
- > Color-coded trays for simple volume and pipette identification

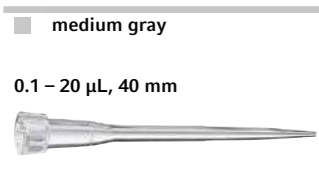

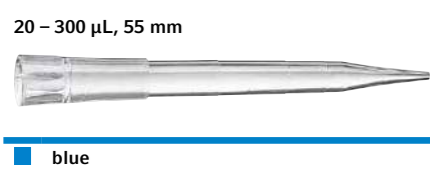
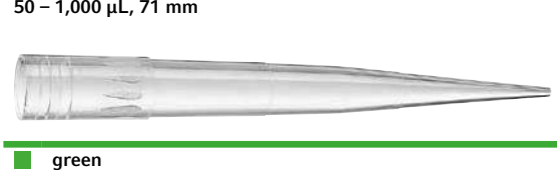





Volume range/epT.I.P.S. <sup>®</sup> (all tips shown are actual size)	Reloads 	Reloads 
 dark gray 0.1 – 10 µL, 34 mm	960 tips (10 trays × 96 tips) 0030 073.363	960 tips (10 trays × 96 tips) 0030 073.746
 medium gray 0.1 – 20 µL, 40 mm	960 tips (10 trays × 96 tips) 0030 073.380	960 tips (10 trays × 96 tips) 0030 073.762
 light gray 0.5 – 20 µL, 46 mm	960 tips (10 trays × 96 tips) 0030 073.401	960 tips (10 trays × 96 tips) 0030 073.789
 yellow 2 – 200 µL, 53 mm	960 tips (10 trays × 96 tips) 0030 073.428	960 tips (10 trays × 96 tips) 0030 073.800
 orange 20 – 300 µL, 55 mm	960 tips (10 trays × 96 tips) 0030 073.444	960 tips (10 trays × 96 tips) 0030 073.827
 blue 50 – 1,000 µL, 71 mm	960 tips (10 trays × 96 tips) 0030 073.460	960 tips (10 trays × 96 tips) 0030 073.843
 green 50 – 1,250 µL, 76 mm	960 tips (10 trays × 96 tips) 0030 073.487	960 tips (10 trays × 96 tips) 0030 073.860

i For more information go to [www.eppendorf.com/epTips](http://www.eppendorf.com/epTips)



Box 	Set 	Singles 	Racks 
1 reusable box × 96 tips 0030 073.002	480 tips (5 trays × 96 tips), 1 reusable box 0030 073.207		
1 reusable box × 96 tips 0030 073.029	480 tips (5 trays × 96 tips), 1 reusable box 0030 073.223	100 tips, individually packed 0030 010.019	480 tips (5 racks × 96 tips) 0030 075.005
1 reusable box × 96 tips 0030 073.045	480 tips (5 trays × 96 tips), 1 reusable box 0030 073.240		
1 reusable box × 96 tips 0030 073.061	480 tips (5 trays × 96 tips), 1 reusable box 0030 073.266	100 tips, individually packed 0030 010.035	480 tips (5 racks × 96 tips) 0030 075.021
1 reusable box × 96 tips 0030 073.088	480 tips (5 trays × 96 tips), 1 reusable box 0030 073.282		480 tips (5 racks × 96 tips) 0030 075.048
1 reusable box × 96 tips 0030 073.100	480 tips (5 trays × 96 tips), 1 reusable box 0030 073.304	100 tips, individually packed 0030 010.051	480 tips (5 racks × 96 tips) 0030 075.064
1 reusable box × 96 tips 0030 073.126	480 tips (5 trays × 96 tips), 1 reusable box 0030 073.320		480 tips (5 racks × 96 tips) 0030 075.080









Volume range/ep.T.I.P.S.<sup>®</sup>  
(all tips shown are actual size)



Reloads

Reloads

<p><b>dark green</b></p> <p>50 – 1,250 µL L, 103 mm</p> 	<p>960 tips (10 trays × 96 tips)</p> <p>0030 073.606</p>	<p>960 tips (10 trays × 96 tips)</p> <p>0030 073.614</p>
<p><b>red</b></p> <p>0.25 – 2.5 mL, 115 mm</p> 	<p>480 tips (10 trays × 48 tips)</p> <p>0030 073.509</p>	<p>480 tips (10 trays × 48 tips)</p> <p>0030 073.886</p>
<p><b>violet</b></p> <p>0.1 – 5 mL, 120 mm</p> 		
<p><b>violet</b></p> <p>0.2 – 5 mL L, 175 mm</p> 		
<p><b>turquoise</b></p> <p>0.5 – 10 mL, 165 mm</p> 		
<p><b>turquoise</b></p> <p>0.5 – 10 mL L, 243 mm</p> 		

(Image reduced size)



Box

Set

Singles

Racks



<p>1 reusable box × 96 tips</p> <p>0030 073.622</p>			<p>480 tips (5 racks × 96 tips)</p> <p>0030 075.129</p>
<p>1 reusable box × 48 tips</p> <p>0030 073.142</p>	<p>240 tips (5 trays × 48 tips), 1 reusable box</p> <p>0030 073.347</p>		<p>240 tips (5 racks × 48 tips)</p> <p>0030 075.102</p>
<p>1 reusable box × 24 tips</p> <p>0030 073.169</p>			<p>120 tips (5 racks × 24 tips)</p> <p>0030 075.137</p>
			<p>120 tips (5 racks × 24 tips)</p> <p>0030 075.188</p>
			<p>120 tips (5 racks × 24 tips)</p> <p>0030 075.145</p>

## MiniSpin®/MiniSpin® plus



\* The MiniSpin®/MiniSpin® plus is designed for separating liquid substance mixtures with different densities, in particular, for processing and analyzing samples from the human body in in-vitro diagnostic applications to ensure that the in-vitro diagnostic device can be used according to its intended purpose. This centrifuge including components is an in-vitro diagnostic device according to Directive 98/79/EC of the European Parliament and the Council dated October 27, 1998. Eppendorf centrifuges are exclusively intended for indoor use by trained specialists.

CE\*

### Ordering information

Description	Order no.
Centrifuge MiniSpin®, non-refrigerated, with Rotor F-45-12-11, 230 V/50 – 60 Hz	5452 000.018
Centrifuge MiniSpin® plus, non-refrigerated, with Rotor F-45-12-11, 230 V/50 – 60 Hz	5453 000.011
Rotor F-45-12-11	5452 720.008
Rotor F-55-16-5-PCR	5452 727.007
Adapter, for 1 tube 0.5 mL, max. Ø 8 mm or microtainer 0.6 mL, max. Ø 8 mm, for all 1.5/2.0 mL rotors, set of 6 pcs.	5425 716.001
Adapter, for 1 tube 0.4 mL, max. Ø 6 mm, for all 1.5/2.0 mL rotors, set of 6 pcs.	5425 717.008
Adapter, for 1 PCR tube 0.2 mL, max. Ø 6 mm, for all 1.5/2.0 mL rotors, set of 6 pcs.	5425 715.005

✎ Ordering information for other voltage options begins on page 434

## Centrifuge 5418/5418 R



\* The Centrifuge 5418/5418 R is designed for separating liquid substance mixtures with different densities, in particular, for processing and analyzing samples from the human body in in-vitro diagnostic applications to ensure that the in-vitro diagnostic device can be used according to its intended purpose. This centrifuge including components is an in-vitro diagnostic device according to Directive 98/79/EC of the European Parliament and the Council dated October 27, 1998. Eppendorf centrifuges are exclusively intended for indoor use by trained specialists.

CE\*

### Ordering information

Description	Order no.
Centrifuge 5418, non-refrigerated, with Rotor FA-45-18-11 and rotor lid, 230 V/50 – 60 Hz, 36 mL	5418 000.017
Centrifuge 5418 R, refrigerated, with Rotor FA-45-18-11 and rotor lid, 230 V/50 – 60 Hz, 36 mL	5401 000.013
Adapter, for 1 tube 0.5 mL, max. Ø 6 mm or microtainer 0.6 mL, max. Ø 8 mm, for all 1.5/2.0 mL rotors, set of 6 pcs.	5425 716.001
Adapter, for 1 tube 0.4 mL, max. Ø 6 mm, for all 1.5/2.0 mL rotors, set of 6 pcs.	5425 717.008
Adapter, for 1 PCR tube 0.2 mL, max. Ø 6 mm, for all 1.5/2.0 mL rotors, set of 6 pcs.	5425 715.005

✎ Ordering information for other voltage options begins on page 434

## Centrifuge 5424 R



CE\*

\* The Centrifuge 5424 R is designed for separating liquid substance mixtures with different densities, in particular, for processing and analyzing samples from the human body in in-vitro diagnostic applications to ensure that the in-vitro diagnostic device can be used according to its intended purpose. This centrifuge including components is an in-vitro diagnostic device according to Directive 98/79/EC of the European Parliament and the Council dated October 27, 1998. Eppendorf centrifuges are exclusively intended for indoor use by trained specialists.

### Ordering information

Description	Order no.
Centrifuge 5424 R, refrigerated, with Rotor FA-45-24-11, rotary knobs, 230 V/50 – 60 Hz	5404 000.413
Centrifuge 5424 R, refrigerated, with Rotor FA-45-24-11, keypad, 230 V/50 – 60 Hz	5404 000.014
Centrifuge 5424 R, refrigerated, without rotor, rotary knobs, 230 V/50 – 60 Hz	5404 000.618
Centrifuge 5424 R, refrigerated, without rotor, keypad, 230 V/50 – 60 Hz	5404 000.219

⚡ Ordering information for other voltage options begins on page 434

ℹ For more information go to [www.eppendorf.com/centrifugation](http://www.eppendorf.com/centrifugation)

## NEW - Centrifuge 5425



CE\*

\* The Centrifuge 5425 is designed for separating liquid substance mixtures with different densities, in particular, for processing and analyzing samples from the human body in in-vitro diagnostic applications to ensure that the in-vitro diagnostic device can be used according to its intended purpose. This centrifuge including components is an in-vitro diagnostic device according to Directive 98/79/EC of the European Parliament and the Council dated October 27, 1998. Eppendorf centrifuges are exclusively intended for indoor use by trained specialists.

### Ordering information

Description	Order no.
Centrifuge 5425, non-refrigerated, without rotor, keypad, 230 V/50 – 60 Hz	5405 000.212
Centrifuge 5425, non-refrigerated, without rotor, rotary knobs, 230 V/50 – 60 Hz	5405 000.611
Centrifuge 5425, non-refrigerated, with Rotor FA-24x2, keypad, 230 V/50 – 60 Hz	5405 000.018
Centrifuge 5425, non-refrigerated, with Rotor FA-24x2, rotary knobs, 230 V/50 – 60 Hz	5405 000.417

⚡ Ordering information for other voltage options begins on page 434

## Centrifuge 5427 R



CE\*

\* The Centrifuge 5427 R is designed for separating liquid substance mixtures with different densities, in particular, for processing and analyzing samples from the human body in in-vitro diagnostic applications to ensure that the in-vitro diagnostic device can be used according to its intended purpose. This centrifuge including components is an in-vitro diagnostic device according to Directive 98/79/EC of the European Parliament and the Council dated October 27, 1998. Eppendorf centrifuges are exclusively intended for indoor use by trained specialists.

## Ordering information

Description	Order no.
Centrifuge 5427 R, refrigerated, rotary knobs, 230 V/50 – 60 Hz	5409 000.012
Centrifuge 5427 R, refrigerated, with Rotor FA-45-30-11, rotary knobs, 230 V/50 – 60 Hz	5409 000.535
Centrifuge 5427 R, refrigerated, with Rotor FA-45-48-11, rotary knobs, 230 V/50 – 60 Hz	5409 000.217
Centrifuge 5427 R, refrigerated, with Rotor FA-45-12-17, rotary knobs, 230 V/50 – 60 Hz	5409 000.632

Ordering information for other voltage options begins on page 434

## Centrifuge 5430/5430 R



\* The Centrifuge 5430/5430 R is designed for separating liquid substance mixtures with different densities, in particular, for processing and analyzing samples from the human body in in-vitro diagnostic applications to ensure that the in-vitro diagnostic device can be used according to its intended purpose. This centrifuge including components is an in-vitro diagnostic device according to Directive 98/79/EC of the European Parliament and the Council dated October 27, 1998. Eppendorf centrifuges are exclusively intended for indoor use by trained specialists.

## Ordering information

Description	Order no.
Centrifuge 5430, non-refrigerated, with Rotor FA-45-30-11 incl. rotor lid, keypad, 230 V/50 – 60 Hz	5427 000.216
Centrifuge 5430, non-refrigerated, with Rotor FA-45-30-11 incl. rotor lid, rotary knobs, 230 V/50 – 60 Hz	5427 000.410
Centrifuge 5430, non-refrigerated, without rotor, keypad, 230 V/50 – 60 Hz	5427 000.011
Centrifuge 5430, non-refrigerated, without rotor, rotary knobs, 230 V/50 – 60 Hz	5427 000.615
Centrifuge 5430 R, refrigerated, with Rotor FA-45-30-11 incl. rotor lid, keypad, 230 V/50 – 60 Hz	5428 000.015
Centrifuge 5430 R, refrigerated, with Rotor FA-45-30-11 incl. rotor lid, rotary knobs, 230 V/50 – 60 Hz	5428 000.414
Centrifuge 5430 R, refrigerated, without rotor, keypad, 230 V/50 – 60 Hz	5428 000.210
Centrifuge 5430 R, refrigerated, without rotor, rotary knobs, 230 V/50 – 60 Hz	5428 000.619

Ordering information for other voltage options begins on page 434

## Centrifuge 5702/5702 R/5702 RH



\* The Centrifuge 5702/5702 R/5702 RH is designed for separating liquid substance mixtures with different densities, in particular, for processing and analyzing samples from the human body in in-vitro diagnostic applications to ensure that the in-vitro diagnostic device can be used according to its intended purpose. This centrifuge including components is an in-vitro diagnostic device according to Directive 98/79/EC of the European Parliament and the Council dated October 27, 1998. Eppendorf centrifuges are exclusively intended for indoor use by trained specialists.

### Ordering information

Description	Order no.
<b>Centrifuge 5702</b> , non-refrigerated, without rotor, rotary knobs, 230 V/50 – 60 Hz	5702 000.019
<b>Centrifuge 5702</b> , non-refrigerated, with Rotor A-4-38 incl. adapters for 15/50 mL conical tubes, rotary knobs, 230 V/50 – 60 Hz	5702 000.329
<b>Centrifuge 5702 R</b> , refrigerated, without rotor, rotary knobs, 230 V/50 – 60 Hz	5703 000.012
<b>Centrifuge 5702 R</b> , refrigerated, with Rotor A-4-38 incl. adapters for 15/50 mL conical tubes, 2 sets of 2 adapters, rotary knobs, 230 V/50 – 60 Hz	5703 000.420
<b>Centrifuge 5702 R</b> , refrigerated, with Rotor A-4-38 incl. adapters for 13/16 mm blood collection tubes, 2 sets of 2 adapters, rotary knobs, 230 V/50 – 60 Hz	5703 000.322
<b>Centrifuge 5702 RH</b> , refrigerated/heated, without rotor, rotary knobs, 230 V/50 – 60 Hz	5704 000.016

✎ Ordering information for other voltage options begins on page 434

## Centrifuge 5804/5804 R and 5810/5810 R



CE\*

\* The Centrifuge 5804/5804 R and 5810/5810 R is designed for separating liquid substance mixtures with different densities, in particular, for processing and analyzing samples from the human body in in-vitro diagnostic applications to ensure that the in-vitro diagnostic device can be used according to its intended purpose. This centrifuge including components is an in-vitro diagnostic device according to Directive 98/79/EC of the European Parliament and the Council dated October 27, 1998. Eppendorf centrifuges are exclusively intended for indoor use by trained specialists.

### Ordering information

Description	Order no.
<b>Centrifuge 5804</b> , non-refrigerated, without rotor, keypad, 230 V/50 – 60 Hz	5804 000.013
<b>Centrifuge 5804 R</b> , refrigerated, without rotor, keypad, 230 V/50 – 60 Hz	5805 000.017
<b>Centrifuge 5810</b> , non-refrigerated, without rotor, keypad, 230 V/50 – 60 Hz	5810 000.017
<b>Centrifuge 5810 R</b> , refrigerated, without rotor, keypad, 230 V/50 – 60 Hz	5811 000.010

✎ Ordering information for other voltage options begins on page 434

## Centrifuge Packages

### Ordering information

Description	Max. capacity of conical tubes per rotor	Order no.
<b>Centrifuge 5702</b> , non-refrigerated, with Rotor A-4-38 incl. adapters for 15/50 mL conical tubes, rotary knobs, 230 V/50 – 60 Hz	8 × 15 mL/4 × 50 mL	5702 000.329
<b>Centrifuge 5702 R</b> , refrigerated, with Rotor A-4-38 incl. adapters for 15/50 mL conical tubes, 2 sets of 2 adapters, rotary knobs, 230 V/50 – 60 Hz	8 × 15 mL/4 × 50 mL	5703 000.420
<b>Centrifuge 5804</b> , non-refrigerated, with Rotor A-4-44 incl. adapters for 15/50 mL conical tubes, keypad, 120 V/50 – 60 Hz	16 × 15 mL/4 × 50 mL	5804 000.323
<b>Centrifuge 5804 R</b> , refrigerated, with Rotor A-4-44 incl. adapters for 15/50 mL conical tubes, keypad, 230 V/50 – 60 Hz	16 × 15 mL/4 × 50 mL	5805 000.327
<b>Centrifuge 5804</b> , non-refrigerated, with Rotor S-4-72 incl. adapters for 15/50 mL conical tubes, keypad, 230 V/50 – 60 Hz	32 × 15 mL/16 × 50 mL	5804 000.528
<b>Centrifuge 5804 R</b> , refrigerated, with Rotor S-4-72 incl. adapters for 15/50 mL conical tubes, keypad, 230 V/50 – 60 Hz	32 × 15 mL/16 × 50 mL	5805 000.629
<b>Centrifuge 5810</b> , non-refrigerated, with Rotor A-4-62 incl. adapters for 15/50 mL conical tubes, keypad, 230 V/50 – 60 Hz	36 × 15 mL/16 × 50 mL	5810 000.327
<b>Centrifuge 5810 R</b> , refrigerated, with Rotor A-4-62 incl. adapters for 15/50 mL conical tubes, keypad, 230 V/50 – 60 Hz	36 × 15 mL/16 × 50 mL	5811 000.320
<b>Centrifuge 5810</b> , non-refrigerated, with Rotor A-4-81 incl. adapters for 15/50 mL conical tubes, keypad, 230 V/50 – 60 Hz	48 × 15 mL/20 × 50 mL	5810 000.424
<b>Centrifuge 5810 R</b> , refrigerated, with Rotor A-4-81 incl. adapters for 15/50 mL conical tubes, keypad, 230 V/50 – 60 Hz	48 × 15 mL/20 × 50 mL	5811 000.428
<b>Centrifuge 5810</b> , non-refrigerated, with Rotor S-4-104 incl. adapters for 15/50 mL conical tubes, keypad, 230 V/50 – 60 Hz	56 × 15 mL/28 × 50 mL	5810 000.521
<b>Centrifuge 5810 R</b> , refrigerated, with Rotor S-4-104 incl. adapters for 15/50 mL conical tubes, keypad, 230 V/50 – 60 Hz	56 × 15 mL/28 × 50 mL	5811 000.622

### Ordering information

Description	Max. capacity of round-bottom tubes per rotor	Order no.
<b>Centrifuge 5810</b> , non-refrigerated, with Rotor S-4-104 incl. adapters for 13/16 mm round-bottom tubes, keypad, 230 V/50 – 60 Hz	92 × 13 mm/80 × 16 mm	5810 000.629
<b>Centrifuge 5810 R</b> , refrigerated, with Rotor S-4-104 incl. adapters for 13/16 mm round-bottom tubes, keypad, 230 V/50 – 60 Hz	92 × 13 mm/80 × 16 mm	5811 000.827

## NEW - Centrifuge 5910 R



CE\*

\* The Centrifuge 5910 R is designed for separating liquid substance mixtures with different densities, in particular, for processing and analyzing samples from the human body in in-vitro diagnostic applications to ensure that the in-vitro diagnostic device can be used according to its intended purpose. This centrifuge including components is an in-vitro diagnostic device according to Directive 98/79/EC of the European Parliament and the Council dated October 27, 1998. Eppendorf centrifuges are exclusively intended for indoor use by trained specialists.

### Ordering information

Description	Order no.
<b>Centrifuge 5910 R</b> , refrigerated, 230 V/50 – 60 Hz	5942 000.016

✎ Ordering information for other voltage options begins on page 434

# Centrifuge 5920 R



As awarded by The Chicago Athenaeum: Museum of Architecture and Design.



CE\*

\* The Centrifuge 5920 R is designed for separating liquid substance mixtures with different densities, in particular, for processing and analyzing samples from the human body in in-vitro diagnostic applications to ensure that the in-vitro diagnostic device can be used according to its intended purpose. This centrifuge including components is an in-vitro diagnostic device according to Directive 98/79/EC of the European Parliament and the Council dated October 27, 1998. Eppendorf centrifuges are exclusively intended for indoor use by trained specialists.

## Ordering information

Description	Order no.
Centrifuge 5920 R, refrigerated, keypad, 230 V/50 – 60 Hz	5948 000.018

✂ Ordering information for other voltage options begins on page 434

# Centrifuge Packages 5910 R/5920 R

## Ordering information

Description	Max. capacity of conical tubes per rotor	Order no.
Centrifuge 5920 R, refrigerated, with Rotor S-4x1000, keypad, 230 V/50 – 60 Hz, incl. high-capacity buckets and adapters for 15 mL/50 mL conical tubes	108 x 15 mL/52 x 50 mL	5948 000.212
Centrifuge 5920 R, refrigerated, with Rotor S-4xUniversal-Large, keypad, 230 V/50 – 60 Hz, incl. universal buckets and adapters for 15 mL/50 mL conical tubes	96 x 15 mL/40 x 50 mL	5948 000.913
Centrifuge 5920 R, refrigerated, with Rotor S-4x1000, keypad, 230 V/50 – 60 Hz, incl. plate/tube buckets and adapters for 15 mL/50 mL conical tubes	88 x 15 mL/40 x 50 mL	5948 000.417
Centrifuge 5910 R, refrigerated, with Rotor S-4xUniversal, 230 V/50 – 60 Hz, incl. universal buckets and adapters for 5 mL/15 mL/50 mL conical tubes and plates	64 x 15 mL/36 x 50 mL	5942 000.318
Centrifuge 5910 R, refrigerated, with Rotor S-4xUniversal, 230 V/50 – 60 Hz, incl. universal buckets and adapters for 5 mL/15 mL/50 mL conical tubes, 175 mL – 250 mL bottles and plates	64 x 15 mL/28 x 50 mL	5942 000.210
Centrifuge 5920 R, refrigerated, with Rotor S-4x1000, keypad, 230 V/50 – 60 Hz, incl. round buckets and adapters for 15 mL/50 mL conical tubes	56 x 15 mL/28 x 50 mL	5948 000.310
Centrifuge 5910 R, refrigerated, with Rotor S-4x750, 230 V/50 – 60 Hz, incl. round buckets and adapters for 5 mL/15 mL/50 mL conical tubes	56 x 15 mL/28 x 50 mL	5942 000.512
Centrifuge 5910 R, refrigerated, with Rotor S-4x500, 230 V/50 – 60 Hz, incl. rectangular buckets and adapters for 15 mL/50 mL conical tubes	48 x 15 mL/20 x 50 mL	5942 000.610
Centrifuge 5910 R, refrigerated, with Rotor S-4x400, 230 V/50 – 60 Hz, incl. round buckets and adapters for 5 mL/15 mL/50 mL conical tubes	28 x 15 mL/16 x 50 mL	5942 000.717

## Ordering information

Description	Max. capacity of round-bottom tubes per rotor	Order no.
Centrifuge 5920 R, refrigerated, with Rotor S-4xUniversal-Large, keypad, 230 V/50 – 60 Hz, incl. universal buckets and adapters for round-bottom tubes with diameter 13/16 mm	196 x 13 mm/148 x 16 mm	5948 000.816
Centrifuge 5920 R, refrigerated, with Rotor S-4x1000, keypad, 230 V/50 – 60 Hz, incl. plate/tube buckets and adapters for round-bottom tubes with diameter 13/16 mm	140 x 13 mm/132 x 16 mm	5948 000.611
Centrifuge 5910 R, refrigerated, with Rotor S-4xUniversal, 230 V/50 – 60 Hz, incl. universal buckets and adapters for round-bottom tubes with diameter 13/16 mm	120 x 13 mm/104 x 16 mm	5942 000.415



# Eppendorf TransferMan® 4m

## Description

The innovative and user-friendly TransferMan 4m continues Eppendorf's 20-year-long tradition in the field of IVF. It has been designed for intuitive operation and optimal performance for a variety of applications in human reproductive medicine. With its exceptionally direct transmission of movement in all directions, the TransferMan 4m provides a "real time feeling" for the user. Its DualSpeed™ joystick features a dynamic speed mode for covering longer distances or speeding up sample processing.



## Product features

- > Unprecedented direct transmission of movement without any recognizable latency
- > Unique DualSpeed™ joystick for precise and instantaneous movement control
- > One-hand operation for capillary and angle settings
- > Programmable Z-axis limit for preventing capillary breakage
- > Maximum stability ensures vibration-free work
- > Can be adapted to all conventional microscopes

\* The TransferMan® 4m was designed and manufactured for the purpose of intracytoplasmic sperm injection (ICSI) within the context of human reproductive medicine. Therefore the TransferMan® 4m is a medical product in accordance with the guideline 93/42/EEC of the European Union. It shall only be used indoors and only by sufficiently trained specialists.

## Applications

- > Micromanipulation of suspension cells (e.g. ICSI)
- > Selection of individual cells (e.g. biopsies, TESE, IMSI)



[www.eppendorf.com/transferman4m](http://www.eppendorf.com/transferman4m)



Workstation for cell transfer – TransferMan 4m mounted on Olympus® IX73



The TransferMan® 4m is designed to ensure optimal results for applications in assisted reproductive technology

Technical specifications	
Model	TransferMan 4m
<b>Motor module set</b>	
<b>Max. traveling distance</b>	≥20 mm in X, Y, Z and X/Z direction
<b>Weight (complete)</b>	2.15 kg
<b>Stepper motor</b>	X-, Y-, Z-module
<b>Single module (X, Y, Z)</b>	
<b>Step size</b>	< 20 nm (computational resolution)
<b>Speed</b>	0 – 10,000 µm/s
<b>Mechanical adjustability</b>	>80 mm
<b>Dimensions</b>	129 × 51 × 36 mm
<b>Weight</b>	570 g
<b>Swivel joint</b>	
<b>Direction of rotation</b>	-45° to +90°
<b>Capillary exchange</b>	Direction of rotation: forward
<b>Sample replacement</b>	Direction of rotation: backward
<b>Angle head</b>	
<b>Operating angle</b>	0° – 90°
<b>Control board</b>	
<b>Control</b>	Joystick (proportional and dynamic kinetics)
<b>Speed modes</b>	coarse, fine, x-fine
<b>Speed control</b>	Proportional and dynamic kinetics
<b>Dimensions (W x H x D)</b>	205 × 288 × 152 mm
<b>Weight</b>	1.8 kg

## Ordering information

Description	Order no.
<b>Eppendorf TransferMan® 4m</b> , micromanipulator with DualSpeed™ joystick for direct and dynamic injection movement control, The TransferMan® 4m was designed and manufactured for the purpose of intracytoplasmic sperm injection (ICSI) within the context of human reproductive medicine.	5191 000.015

# NEW - CellTram® 4m Air/Oil

## Description

The CellTram 4m Air and CellTram 4m Oil are manual microinjectors for use in assisted reproductive technology. The CellTram 4m Air is a pneumatic injector for oil-free micromanipulation and gentle holding of oocytes and embryos. Due to its excellent performance, it is also highly suitable for uptake and injection of cells (e.g., sperm). For this application, its performance is comparable to that of oil-filled injectors. The CellTram 4m Oil is a hydraulic, oil-filled microinjector optimized for leakage-free work and easy oil filling.



CE\*

\* The CellTram 4m was designed and manufactured for injection and aspiration of cells or cellular parts in the context of ex-vivo micromanipulations in combination with suitable microcapillaries in the area of human reproductive medicine. Therefore the CellTram 4m is a medical product in accordance with the guideline 93/42/EWG of the European Union. It shall only be used indoors and only by sufficiently trained specialists.

## Product features

- > Non-hydraulic system for oil-free manipulation and injection of cells (CellTram 4m Air)
- > Piston position scale enables setting of air volume and injection characteristics according to individual needs (CellTram 4m Air)
- > Improved oil-filling system for minimal interruption of the workflow (CellTram 4m Oil)
- > Coarse and fine drive for precise and intuitive sample control
- > Improved rotary knob design for better handling and easier cleaning
- > Capillary holder 4 with markings for easier positioning
- > New grip head 4 system for simple capillary change and higher user safety
- > Position indicators and marking for in/out to reduce risk of user errors
- > Stable, nonslip base plate
- > Highly reliable performance with minimal maintenance

## Applications

- > Intracytoplasmic sperm injection (ICSI)
- > Gentle holding of cells or embryos (e.g., oocytes or blastocysts)
- > Uptake and microinjection of small cells (e.g., sperm)
- > Transfer of suspension cells or organelles
- > Removal of cells (e.g., for embryo biopsies)



Piston position scale indicates instrument status and allows for setting pressure characteristics according to individual needs



The new oil-filling system helps avoid oil-spilling and facilitates the filling process

## Technical specifications

Model	CellTram 4m Air	CellTram 4m Oil
Cylinder volume	10 mL	1,000 µL
Max. pressure	3,000 hPa	20,000 hPa
Min. adjustable volume	< 100 nL	< 1.5 nL
Pressure generation	Cylinder/piston system, air-filled	Cylinder/piston system, oil-filled
Volume change per revolution	60 µL/600 µL	1 µL/10 µL

## Ordering information

Description	Order no.
<b>CellTram® 4m Air</b> , manual pneumatic microinjector, with gears 1:1 and 1:10, for holding and injection, The CellTram 4m was designed and manufactured for injection and aspiration of cells or cellular parts in the context of ex-vivo micromanipulations in combination with suitable microcapillaries in the area of human reproductive medicine.	5196 000.021
<b>CellTram® 4m Oil</b> , manual hydraulic microinjector, with gears 1:1 and 1:10, for holding and injection, The CellTram 4m was designed and manufactured for injection and aspiration of cells or cellular parts in the context of ex-vivo micromanipulations in combination with suitable microcapillaries in the area of human reproductive medicine.	5196 000.048
<b>Capillary holder 4</b> , for mounting microcapillaries, Femtotips, Femtotip II or grip head 4 (incl. Grip head 4 size 0 and adapter for Femtotips)	5196 081.005
<b>Capillary holder 4 slim shape</b> , for flat angle injections, for microcapillaries with outer diameter 1.0 mm	5196 062.000
<b>Filling and Cleaning set</b> , incl. filling tube, Luer lock adapter, 2 syringes for CellTram 4	5196 088.000
<b>Grip head set 4 size 0</b> , for microcapillaries with outer diameter 1.0 to 1.1 mm	5196 082.001
<b>Grip head set 4 size 1</b> , for microcapillaries with outer diameter 1.2 to 1.3 mm	5196 083.008
<b>Grip head set 4 size 2</b> , for microcapillaries with outer diameter 1.4 to 1.5 mm	5196 084.004
<b>Grip head set 4 size 3</b> , for microcapillaries with outer diameter 0.7 to 0.9 mm	5196 085.000
<b>Injection tube Air</b> , white ring mark, I.D. 0.5 mm, length 1.3 m	5196 061.004
<b>Injection tube Oil</b> , blue ring mark, I.D. 1.0 mm, length 1.3 m	5196 089.006
<b>O-ring set 4</b> , incl. 10 o-rings large, 10 o-rings small, 2 distance sleeves, o-ring removal tool for grip head set 4	5196 086.007

## Order Numbers for Different Mains Voltage Versions



The following products are available in the listed mains voltage versions. For mains voltage versions for which no separate order number is listed, the valid order numbers are also those listed in the first column or in

the product description. The versions marked n.a. are not available. Order-related production is marked with \*

Power supply	International	UK/HKG	Australia	China	Japan	Argentina	ROW
epMotion® 96	5069 000.012	5069 000.020	5069 000.039	5069 000.047	5069 000.004	5069 000.055	5069 000.004
epMotion® 96 with 2-position slider	5069 000.110	5069 000.128	5069 000.136	5069 000.144	5069 000.101	5069 000.152	5069 000.101
epMotion® 96xl	5069 000.217	5069 000.225	5069 000.233	5069 000.241	5069 000.209	5069 000.250	5069 000.209
epMotion® 96xl with 2-position slider	5069 000.314	5069 000.322	5069 000.330	5069 000.349	5069 000.306	5069 000.357	5069 000.306
epMotion® 5070 EasyCon	5070 006.032	5070 007.002	5070 007.003	5070 007.004	5070 007.001	5070 007.005	5070 007.001
epMotion® 5070f EasyCon	5070 006.108	5070 007.102	5070 007.103	5070 007.104	5070 007.101	5070 007.105	5070 007.101
epMotion® 5070 MultiCon	5070 000.282	5070 007.012	5070 007.013	5070 007.014	5070 007.011	5070 007.015	5070 007.011
epMotion® 5070f MultiCon	5070 000.283	5070 007.112	5070 007.113	5070 007.114	5070 007.111	5070 007.115	5070 007.111
epMotion® P5073	5073 000.000	5073 000.227	5073 000.035	5073 000.043	5073 000.019	5073 000.051	5073 000.019
epMotion® M5073	5073 000.205	5073 000.221	5073 000.230	5073 000.248	5073 000.507	5073 000.256	5073 000.213
epMotion® P5073c	5073 000.302	5073 007.202	5073 007.203	5073 007.204	5073 007.201	5073 007.205	5073 007.201
epMotion® M5073c	5073 000.400	5073 007.302	5073 007.303	5073 007.304	5073 000.515	5073 007.305	5073 007.301
epMotion® 5073l EasyCon	5073 000.582	5073 007.402	5073 007.403	5073 007.404	5073 007.401	5073 007.405	5073 007.401
epMotion® 5073l MultiCon	5073 000.590	5073 007.412	5073 007.413	5073 007.414	5073 007.411	5073 007.415	5073 007.411
epMotion® 5073lc EasyCon	5073 000.604	5073 007.502	5073 007.503	5073 007.504	5073 007.501	5073 007.505	5073 007.501
epMotion® 5073lc MultiCon	5073 000.612	5073 007.512	5073 007.513	5073 007.514	5073 007.511	5073 007.515	5073 007.511
epMotion® 5073m EasyCon	5073 000.787	5073 007.802	5073 007.803	5073 007.804	n.a.	5073 007.805	5073 007.801
epMotion® 5073m MultiCon	5073 000.795	5073 007.812	5073 007.813	5073 007.814	5073 000.884	5073 007.815	5073 007.811
epMotion® 5073mc EasyCon	5073 000.809	5073 007.902	5073 007.903	5073 007.904	n.a.	5073 007.905	5073 007.901
epMotion® 5073mc MultiCon	5073 000.817	5073 007.912	5073 007.913	5073 007.914	5073 000.892	5073 007.915	5073 007.911
epMotion® 5075l	5075 000.301	*	*	*	*	*	*
epMotion® 5075t	5075 000.302	*	*	*	*	*	*
epMotion® 5075v	5075 000.303	*	*	*	*	*	*
epMotion® 5075vt	5075 000.304	*	*	*	*	*	*
epMotion® 5075m	5075 000.305	*	*	*	*	*	*

Power supply	International	UK/HKG	Australia	China	Japan	Argentina	ROW
Eppendorf ThermoMixer® C, basic device without thermoblock	5382 000.015	5382 000.031	5382 000.066	5382 000.074	5382 000.023	5382 000.082	5382 000.023
Eppendorf ThermoMixer® F0.5, with thermoblock for 24 reaction vessels 0.5 mL	5386 000.010	5386 000.036	5386 000.060	5386 000.079	5386 000.028	5386 000.087	5386 000.028
Eppendorf ThermoMixer® F1.5, with thermoblock for 24 reaction vessels 1.5 mL	5384 000.012	5384 000.039	5384 000.063	5384 000.071	5384 000.020	5384 000.080	5384 000.020
Eppendorf ThermoMixer® F2.0, with thermoblock for 24 reaction vessels 2.0 mL	5387 000.013	5387 000.030	5387 000.064	5387 000.072	5387 000.021	5387 000.080	5387 000.021
Eppendorf ThermoMixer® FP, with thermoblock for Microplates and Deepwell Plates, including lid	5385 000.016	5385 000.032	5385 000.067	5385 000.075	5385 000.024	5385 000.083	5385 000.024
Eppendorf ThermoStat™ C, basic device without thermoblock	5383 000.019	5383 000.035	5383 000.060	5383 000.078	5383 000.027	5383 000.086	5383 000.027
MixMate®, incl. 3 tube holders: PCR 96, 0.5 mL, 1.5/2.0 mL	5353 000.014	5353 000.030	5353 000.073	5353 000.081	n.a.	n.a.	5353 000.022

## General Lab Products

Power supply	International	UK/HKG	Australia	China	Japan	Argentina	ROW
Centrifuge MiniSpin® plus, with Rotor F-45-12-11	5453 000.015	5452 000.060	5452 000.085		n.a.	n.a.	n.a.
Centrifuge MiniSpin®, with Rotor F-45-12-11	5452 000.010	5453 000.060	5453 000.089		n.a.	n.a.	n.a.
Centrifuge 5418 R, with Rotor FA-45-18-11 and rotor lid	5401 000.010	5401 000.060	5401 000.080		5401 000.030	5401 000.056	5401 000.021
Centrifuge 5424 R, with Rotor FA-45-24-11	5404 000.010	5404 000.060	5404 000.081		5404 000.030	5404 000.057	5404 000.022
Centrifuge 5424 R, with Rotor FA-45-24-11	5404 000.410	5404 000.460	5404 000.480		5404 000.430	5404 000.456	5404 000.421
Centrifuge 5424 R, without rotor	5404 000.610	5404 000.265	5404 000.286		n.a.	5404 000.251	5404 000.227
Centrifuge 5424 R, without rotor	5404 000.210	5404 000.660	5404 000.685		5404 000.634	5404 000.650	5404 000.626
Centrifuge 5427 R	5409 000.010	5409 000.060	5409 000.080		5409 000.039	5409 000.055	5409 000.020
Centrifuge 5427 R, with Rotor FA-45-12-17	5409 000.630	5409 000.660	5409 000.683		n.a.	5409 000.659	5409 000.624
Centrifuge 5427 R, with Rotor FA-45-30-11	5409 000.530	5409 000.565	5409 000.586		5409 000.519	5409 000.551	5409 000.527
Centrifuge 5427 R, with Rotor FA-45-48-11	5409 000.210	5409 000.260	5409 000.284		5409 000.233	5409 000.250	5409 000.225
Centrifuge 5430 R, with Rotor FA-45-30-11 incl. rotor lid	5428 000.010	5428 000.060	5428 000.082		5428 000.031	5428 000.058	5428 000.023
Centrifuge 5430 R, with Rotor FA-45-30-11 incl. rotor lid	5428 000.410	5428 000.460	5428 000.481		5428 000.430	5428 000.457	5428 000.422
Centrifuge 5430 R, without rotor	5428 000.205	5428 000.255	5428 000.287		5428 000.236	5428 000.252	5428 000.228
Centrifuge 5430 R, without rotor	5428 000.610	5428 000.655	5428 000.686		5428 000.635	5428 000.651	5428 000.627
Centrifuge 5430, with Rotor FA-45-30-11 incl. rotor lid	5427 970.900	5427 970.910	5427 000.283		5427 000.232	5427 000.259	5427 000.224
Centrifuge 5430, with Rotor FA-45-30-11 incl. rotor lid	5427 000.415	5427 000.465	5427 000.488		5427 000.437	5427 000.453	5427 000.429
Centrifuge 5430, without rotor	5427 000.015	5427 000.060	5427 000.089		5427 000.038	5427 000.054	5427 000.020
Centrifuge 5430, without rotor	5427 000.610	5427 000.660	5427 000.682		5427 000.631	5427 000.658	n.a.

## IVD Products

Power supply	International	UK	Australia	China	Japan	Argentina	ROW
Centrifuge MiniSpin® plus, with Rotor F-45-12-11	5453 000.011	5452 000.069		5452 000.093			
Centrifuge MiniSpin®, with Rotor F-45-12-11	5452 000.018	5453 000.062		5453 000.097			
Centrifuge 5418 R, with Rotor FA-45-18-11 and rotor lid	5401 000.013	5401 000.064		5401 000.099			
Centrifuge 5418, with Rotor FA-45-18-11 and rotor lid	5418 000.017	5418 000.068		5418 000.092			
Centrifuge 5424 R, with Rotor FA-45-24-11	5404 000.014	5404 000.065		5404 000.090			
Centrifuge 5424 R, with Rotor FA-45-24-11	5404 000.413	5404 000.464		5404 000.499			
Centrifuge 5424 R, without rotor	5404 000.219	5404 000.260		5404 000.294			
Centrifuge 5424 R, without rotor	5404 000.618	5404 000.669		5404 000.693			
Centrifuge 5427 R	5409 000.012	5409 000.063		5409 000.098			
Centrifuge 5427 R, with Rotor FA-45-12-17	5409 000.632	5409 000.667		5409 000.691			
Centrifuge 5427 R, with Rotor FA-45-30-11	5409 000.535	5409 000.560		5409 000.594			
Centrifuge 5427 R, with Rotor FA-45-48-11	5409 000.217	5409 000.268		5409 000.292			
Centrifuge 5430 R, with Rotor FA-45-30-11 incl. rotor lid	5428 000.015	5428 000.066		5428 000.090			
Centrifuge 5430 R, with Rotor FA-45-30-11 incl. rotor lid	5428 000.414	5428 000.465		5428 000.490			
Centrifuge 5430 R, without rotor	5428 000.210	5428 000.260		5428 000.295			
Centrifuge 5430 R, without rotor	5428 000.619	5428 000.660		5428 000.694			
Centrifuge 5430, with Rotor FA-45-30-11 incl. rotor lid	5427 000.216	5427 000.267		5427 000.291			
Centrifuge 5430, with Rotor FA-45-30-11 incl. rotor lid	5427 000.410	5427 000.461		5427 000.496			
Centrifuge 5430, without rotor	5427 000.011	5427 000.062		5427 000.097			
Centrifuge 5430, without rotor	5427 000.615	5427 000.666		5427 000.690			

# Order Numbers for Different Mains Voltage Versions

## General Lab Products

Power supply	International	UK/HKG	Australia	China	Japan	Argentina	ROW
Centrifuge 5702, with Rotor A-4-38 incl. adapters for 15/50 mL conical tubes	5702 000.320	5702 000.365	5702 000.388		n.a.	5702 000.353	5702 000.345
Centrifuge 5702 R, with Rotor A-4-38 incl. adapters for 15/50 mL conical tubes, 2 sets of 2 adapters	5703 000.425	5703 000.460	5703 000.489		n.a.	5703 000.454	5703 000.470
Centrifuge 5702 R, with Rotor A-4-38 incl. adapters for 13/16 mm blood collection tubes, 2 sets of 2 adapters	5703 000.320	5703 000.360	5703 000.381		n.a.	5703 000.357	5703 000.349
Centrifuge 5702 R, without rotor	5703 000.010	5703 000.060	5703 000.080		5703 000.039	5703 000.055	5703 000.047
Centrifuge 5702 RH, without rotor	5704 000.010	5704 000.060	5704 000.083		5704 000.032	5704 000.059	5704 000.040
Centrifuge 5702, without rotor	5702 000.010	5702 000.065	5702 000.086		5702 000.043	5702 000.051	5702 000.817
Centrifuge 5804, with Rotor A-4-44 incl. adapters for 15/50 mL conical tubes	5804 000.320	5804 000.360	5804 000.382		*	5804 000.358	5804 000.374
Centrifuge 5804, with Rotor S-4-72 incl. adapters for 15/50 mL conical tubes	5804 000.520	5804 000.565	5804 000.587		*	5804 000.552	5804 000.544
Centrifuge 5804, with Rotor A-4-44 incl. adapters for 15/50 mL conical tubes	5804 000.320	5805 000.365	5805 000.386		*	5805 000.351	5805 000.378
Centrifuge 5804, with Rotor S-4-72 incl. adapters for 15/50 mL conical tubes	5804 000.520	5805 000.665	5805 000.688		*	5805 000.653	5805 000.645
Centrifuge 5804 R, without rotor	5805 000.010	5805 000.060	5805 000.084		n.a.	5805 000.050	n.a.
Centrifuge 5804, without rotor	5804 000.010	5804 000.060	5804 000.080		n.a.	5804 000.056	5804 000.170
Centrifuge 5810, with Rotor A-4-62 incl. adapters for 15/50 mL conical tubes	5810 000.320	5810 000.365	5810 000.386		5810 000.378	5810 000.351	5810 000.378
Centrifuge 5810, with Rotor A-4-81 incl. adapters for 15/50 mL conical tubes	5810 000.420	5810 000.460	5810 000.483		*	5810 000.459	5810 000.475
Centrifuge 5810, with Rotor S-4-104 incl. adapters for 15/50 mL conical tubes	5810 000.525	5810 000.564	5810 000.580		*	5810 000.556	5810 000.548
Centrifuge 5810, with Rotor S-4-104 incl. adapters for 13/16 mm round-bottom tubes	5810 000.620	5810 000.665	5810 000.688		*	5810 000.653	5810 000.670
Centrifuge 5810 R, with Rotor A-4-62 incl. adapters for 15/50 mL conical tubes	5811 000.325	5811 000.360	5811 000.380		*	5811 000.355	5811 000.371
Centrifuge 5810 R, with Rotor A-4-81 incl. adapters for 15/50 mL conical tubes	5811 000.420	5811 000.465	5811 000.487		*	5811 000.452	5811 000.479
Centrifuge 5810 R, with Rotor S-4-104 incl. adapters for 15/50 mL conical tubes	5811 000.620	5811 000.660	5811 000.681		*	5811 000.657	5811 000.649
Centrifuge 5810 R, with Rotor S-4-104 incl. adapters for 13/16 mm round-bottom tubes	5811 000.820	5810 000.665	5811 000.886		*	5811 000.851	5811 000.843
Centrifuge 5810 R, without rotor	5811 000.015	5811 000.065	5811 000.088		n.a.	n.a.	n.a.
Centrifuge 5810, without rotor	5810 000.010	5810 000.060	5810 000.084		n.a.	5810 000.050	5810 000.190
Centrifuge 5910 R	5942 000.010	5942 000.060	5942 000.083			5942 000.059	5942 000.024
Centrifuge 5910 R, with Rotor S-4xUniversal	5942 000.215	5942 000.265	5942 000.288			5942 000.253	5942 000.229
Centrifuge 5910 R, with Rotor S-4xUniversal	5942 000.315	5942 000.360	5942 000.385			5942 000.350	5942 000.326
Centrifuge 5910 R, with Rotor S-4xUniversal	5942 000.410	5942 000.460	5942 000.482			5942 000.458	5942 000.423
Centrifuge 5910 R, with Rotor S-4x750	5942 000.515	5942 000.560	5942 000.580			5942 000.555	5942 000.520
Centrifuge 5910 R, with Rotor S-4x500	5942 000.615	5942 000.665	5942 000.687			5942 000.652	5942 000.628
Centrifuge 5910 R, with Rotor S-4x400	5942 000.710	5942 000.760	5942 000.784			5942 000.750	5942 000.725
Centrifuge 5920 R	5948 000.010	5948 000.060	5948 000.085			5948 000.050	5948 000.026
Centrifuge 5920 R, with Rotor S-4x1000	5948 000.210	5948 000.260	5948 000.280			5948 000.255	5948 000.220
Centrifuge 5920 R, with Rotor S-4x1000	5948 000.315	5948 000.365	5948 000.387			5948 000.352	5948 000.328
Centrifuge 5920 R, with Rotor S-4x1000	5948 000.410	5948 000.460	5948 000.484			5948 000.450	5948 000.425
Centrifuge 5920 R, with Rotor S-4x1000	5948 000.615	5948 000.660	5948 000.689			5948 000.654	5948 000.620
Centrifuge 5920 R, with Rotor S-4x750	5948 000.510	5948 000.560	5948 000.581			5948 000.557	5948 000.522
Centrifuge 5920 R, with Rotor S-4x1000	5948 000.710	5948 000.765	5948 000.786			5948 000.751	5948 000.727
Centrifuge 5920 R, with Rotor S-4xUniversal-Large	5948 000.810	5948 000.860	5948 000.883			5948 000.859	5948 000.824
Centrifuge 5920 R, with Rotor S-4xUniversal-Large	5948 000.910	5948 000.960	5948 000.980			5948 000.956	5948 000.921
Concentrator plus basic device	5305 000.100	5305 000.169	5305 000.185	5305 000.193	5305 000.142	5305 000.150	n.a.
Concentrator plus complete system	5305 000.304	5305 000.363	5305 000.380	5305 000.398	5305 000.347	5305 000.355	5305 000.371
Concentrator plus complete system	5305 000.509	5305 000.568	5305 000.584	5305 000.592	5305 000.541	5305 000.550	5305 000.576
Concentrator plus complete system	5305 000.703	5305 000.762	5305 000.589	5305 000.797	5305 000.746	5305 000.754	5305 000.770

## IVD Products

Power supply	International	UK	Australia	China	Japan	Argentina	ROW
Centrifuge 5702, with Rotor A-4-38 incl. adapters for 15/50 mL conical tubes	5702 000.329	5702 000.361		5702 000.396			
Centrifuge 5702 R, with Rotor A-4-38 incl. adapters for 15/50 mL conical tubes, 2 sets of 2 adapters	5703 000.420	5703 000.462		5703 000.497			
Centrifuge 5702 R, with Rotor A-4-38 incl. adapters for 13/16 mm blood collection tubes, 2 sets of 2 adapters	5703 000.322	5703 000.365		5703 000.390			
Centrifuge 5702 R, without rotor	5703 000.012	5703 000.063		5703 000.098			
Centrifuge 5702 RH, without rotor	5704 000.016	5704 000.067		5704 000.091			
Centrifuge 5702, without rotor	5702 000.019	5702 000.060		5702 000.094			
Centrifuge 5804, with Rotor A-4-44 incl. adapters for 15/50 mL conical tubes	5804 000.323	5804 000.366		5804 000.390			
Centrifuge 5804, with Rotor S-4-72 incl. adapters for 15/50 mL conical tubes	5804 000.528	5804 000.560		5804 000.595			
Centrifuge 5804 R, with Rotor A-4-44 incl. adapters for 15/50 mL conical tubes	5805 000.327	5805 000.360		5805 000.394			
Centrifuge 5804 R, with Rotor S-4-72 incl. adapters for 15/50 mL conical tubes	5805 000.629	5805 000.661		5805 000.696			
Centrifuge 5804 R, without rotor	5805 000.017	5805 000.068		5805 000.092			
Centrifuge 5804, without rotor	5804 000.013	5804 000.064		5804 000.099			
Centrifuge 5810, with Rotor A-4-62 incl. adapters for 15/50 mL conical tubes	5810 000.327	5810 000.360		5810 000.394			
Centrifuge 5810, with Rotor A-4-81 incl. adapters for 15/50 mL conical tubes	5810 000.424	5810 000.467		5810 000.491			
Centrifuge 5810, with Rotor S-4-104 incl. adapters for 15/50 mL conical tubes	5810 000.521	5810 000.564		5810 000.599			
Centrifuge 5810, with Rotor S-4-104 incl. adapters for 13/16 mm round-bottom tubes	5810 000.629	5810 000.661		5810 000.696			
Centrifuge 5810 R, with Rotor A-4-62 incl. adapters for 15/50 mL conical tubes	5811 000.320	5811 000.363		5811 000.398			
Centrifuge 5810 R, with Rotor A-4-81 incl. adapters for 15/50 mL conical tubes	5811 000.428	5811 000.460		5811 000.495			
Centrifuge 5810 R, with Rotor S-4-104 incl. adapters for 15/50 mL conical tubes	5811 000.622	5811 000.665		5811 000.690			
Centrifuge 5810 R, with Rotor S-4-104 incl. adapters for 13/16 mm round-bottom tubes	5811 000.827	5811 000.860		5811 000.894			
Centrifuge 5810 R, without rotor	5811 000.010	5811 000.061		5811 000.096			
Centrifuge 5810, without rotor	5810 000.017	5810 000.068		5810 000.092			
Centrifuge 5910 R	5942 000.016	5942 000.067		5942 000.091			
Centrifuge 5910 R, with Rotor S-4xUniversal	5942 000.210	5942 000.261		5942 000.296			
Centrifuge 5910 R, with Rotor S-4xUniversal	5942 000.318	5942 000.369		5942 000.393			
Centrifuge 5910 R, with Rotor S-4xUniversal	5942 000.415	5942 000.466		5942 000.490			
Centrifuge 5910 R, with Rotor S-4x750	5942 000.512	5942 000.563		5942 000.598			
Centrifuge 5910 R, with Rotor S-4x500	5942 000.610	5942 000.660		5942 000.695			
Centrifuge 5910 R, with Rotor S-4x400	5942 000.717	5942 000.768		5942 000.792			
Centrifuge 5920 R	5948 000.018	5948 000.069		5948 000.093			
Centrifuge 5920 R, with Rotor S-4x1000	5948 000.212	5948 000.263		5948 000.298			
Centrifuge 5920 R, with Rotor S-4x1000	5948 000.310	5948 000.360		5948 000.395			
Centrifuge 5920 R, with Rotor S-4x1000	5948 000.417	5948 000.468		5948 000.492			
Centrifuge 5920 R, with Rotor S-4x1000	5948 000.611	5948 000.662		5948 000.697			
Centrifuge 5920 R, with Rotor S-4x750	5948 000.514	5948 000.565		5948 000.590			
Centrifuge 5920 R, with Rotor S-4x1000	5948 000.719	5948 000.760		5948 000.794			
Centrifuge 5920 R, with Rotor S-4xUniversal-Large	5948 000.816	5948 000.867		5948 000.891			
Centrifuge 5920 R, with Rotor S-4xUniversal-Large	5948 000.913	5948 000.964		5948 000.999			
Concentrator plus basic device	5305 000.100	5305 000.169	5305 000.185	5305 000.193	5305 000.142	5305 000.150	n.a.
Concentrator plus complete system	5305 000.304	5305 000.363	5305 000.380	5305 000.398	5305 000.347	5305 000.355	5305 000.371
Concentrator plus complete system	5305 000.509	5305 000.568	5305 000.584	5305 000.592	5305 000.541	5305 000.550	5305 000.576
Concentrator plus complete system	5305 000.703	5305 000.762	5305 000.589	5305 000.797	5305 000.746	5305 000.754	5305 000.770

## Order Numbers for Different Mains Voltage Versions

Power supply	International	UK/HKG	Australia	China	Japan	Argentina	ROW
Eppendorf BioPhotometer® D30	6133 000.001	6133 000.028	6133 000.036	6133 000.044	6133 000.010	6133 000.052	6133 000.010
Eppendorf µCuvette® G1.0 and Eppendorf BioPhotometer® D30	6133 000.907	6133 000.909	6133 000.910	6133 000.911	6133 000.908	6133 000.912	6133 000.908
Eppendorf BioSpectrometer® basic	6135 000.009	6135 000.025	6135 000.033	6135 000.041	6135 000.017	6135 000.050	6135 000.050
Eppendorf BioSpectrometer® fluorescence	6137 000.006	6137 000.022	6137 000.030	6137 000.049	6137 000.014	6137 000.057	6137 000.014
Eppendorf µCuvette® G1.0 and Eppendorf BioSpectrometer® fluorescence	6137 000.901	6137 000.903	6137 000.904	6137 000.905	6137 000.902	6137 000.906	6137 000.902
Eppendorf BioSpectrometer® kinetic	6136 000.002	6136 000.029	6136 000.037	6136 000.045	6136 000.010	6136 000.053	6136 000.053
Eppendorf µCuvette® G1.0 and Eppendorf BioSpectrometer® kinetic	6136 000.800	6136 000.029	6136 000.827	6136 000.835	6136 000.851	6136 000.843	6136 000.851
Eppendorf µCuvette® G1.0 and Eppendorf BioSpectrometer® basic	6135 000.904	6135 000.906	6135 000.907	6135 000.908	6135 000.905	6135 000.909	6135 000.905
Thermal Printer DPU-S445	6135 011.000	6135 012.007	n.a.	n.a.	6135 010.004	n.a.	6135 011.000

Power supply	International	UK/HKG	Australia	China	Japan	Argentina	ROW
Mastercycler® nexus	6333 000.014	6333 000.049	6333 000.065	6333 000.073	6333 000.030	n.a.	6333 000.030
Mastercycler® nexus eco	6332 000.010	6332 000.045	6332 000.061	6332 000.070	6332 000.037	n.a.	6332 000.037
Mastercycler® nexus gradient	6331 000.017	6331 000.041	6331 000.068	6331 000.076	6331 000.033	n.a.	6331 000.033
Mastercycler® nexus flat	6335 000.011	6335 000.046	6335 000.062	6335 000.070	6335 000.038	6335 000.089	6335 000.038
Mastercycler® nexus flat eco	6330 000.013	6330 000.048	6330 000.064	6330 000.072	6330 000.021	6330 000.080	6330 000.021
Mastercycler® nexus GSX1	6345 000.010	6345 000.044	6345 000.060	6345 000.079	6345 000.028	6345 000.087	6345 000.028
Mastercycler® nexus GSX1e	6347 000.017	6347 000.041	6347 000.068	6347 000.076	6347 000.025	6347 000.084	6347 000.025
Mastercycler® nexus SX1e	6348 000.010	6348 000.045	6348 000.061	6348 000.070	6348 000.029	6348 000.088	6348 000.029
Mastercycler® nexus SX1	6346 000.013	6346 000.048	6346 000.064	6346 000.072	6346 000.021	6346 000.080	6346 000.021
Mastercycler® nexus GX2	6336 000.015	6336 000.040	6336 000.066	6336 000.074	n.a.	6336 000.082	6336 000.023
Mastercycler® nexus GX2e	6338 000.012	6338 000.047	6338 000.063	6338 000.071	n.a.	6338 000.080	6338 000.020
Mastercycler® nexus X2	6337 000.019	6337 000.043	6337 000.060	6337 000.078	6337 000.027	6337 000.086	n.a.
Mastercycler® nexus X2e	6339 000.016	6339 000.040	6339 000.067	6339 000.075	n.a.	6339 000.083	6339 000.024
Mastercycler® X50s	6311 000.010	6311 000.045	6311 000.061	6311 000.070	n.a.	6311 000.088	n.a.
Mastercycler® X50a	6313 000.018	6313 000.042	6313 000.069	6313 000.077	n.a.	6313 000.085	n.a.
Mastercycler® X50p	6315 000.015	6315 000.040	6315 000.066	6315 000.074	n.a.	n.a.	n.a.
Mastercycler® X50h	6316 000.019	6316 000.043	6316 000.060	6316 000.078	n.a.	6316 000.086	n.a.
Mastercycler® X50i	6301 000.012	6301 000.047	6301 000.063	6301 000.071	n.a.	6301 000.080	n.a.
Mastercycler® X50l	6303 000.010	6303 000.044	6303 000.060	6303 000.079	n.a.	6303 000.087	n.a.
Mastercycler® X50r	6305 000.017	6305 000.041	6305 000.068	6305 000.076	n.a.	6305 000.084	n.a.
Mastercycler® X50t	6306 000.010	6306 000.045	6306 000.061	6306 000.070	n.a.	6306 000.088	n.a.

Power supply	International	UK/HKG	Australia	China	Japan	Argentina	ROW
Eppendorf Eporator®, for bacteria and yeasts	4309 000.019	4309 000.035	4309 000.051	4309 000.060	4309 000.027	4309 000.078	n.a.
Eppendorf PiezoXpert®, for piezo-assisted micromanipulation, incl. actuator 2, foot control and spacer plate and grip head 4 size 0	5194 000.016	5194 000.032	5194 000.059	5194 000.067	5194 000.024	5194 000.075	n.a.
FemtoJet® 4x, programmable microinjector with external pressure supply (not included)	5253 000.017	5253 000.033	5253 000.050	5253 000.068	5253 000.025	5253 000.076	n.a.
FemtoJet® 4i, programmable microinjector with integrated pressure supply	5252 000.013	5252 000.030	5252 000.056	5252 000.064	5252 000.021	5252 000.072	n.a.
Eppendorf InjectMan® 4, micromanipulator with dynamic movement control	5192 000.019	5192 000.035	5192 000.043	5192 000.051	5192 000.027	5192 000.060	n.a.
Eppendorf TransferMan® 4m, micromanipulator with DualSpeed™ joystick for direct and dynamic movement control <sup>1)</sup>	5191 000.015	5191 000.031	n.a.	n.a.	n.a.	n.a.	n.a.
Eppendorf TransferMan® 4r, micromanipulator with DualSpeed™ joystick for direct and dynamic movement control	5193 000.012	5193 000.039	5193 000.047	5193 000.055	5193 000.020	5193 000.063	n.a.

<sup>1)</sup> For availability in your country, please contact your local sales organization.

Power supply	230 V, 50 Hz	120 V, 60 Hz	208-230 V, 60 Hz	120-220 V, 60 Hz
CryoCube® F570h	F570320001	F570220005		
CryoCube® F570hw	F570320101			
CryoCube® FC660h	F660320001		F660420005	
HEF® U410	U9260-0008	U9260-0007		
Innova® U101	U9420-0001	U9420-0000		
Innova® U360	U9425-0001	U9425-0000		
Innova® U535	U9430-0001	U9430-0000	U9430-0002	
Innova® C585	U9400-0001	U9400-0000	U9400-0002	
Innova® C760	U9410-0001		U9410-0002	
CryoCube® F570	F570300001	F570200005	F570400005	
CryoCube® FC660	F660300001		F660400005	
Premium U410	U9260-0001	U9260-0000	U9260-0002	
CO <sub>2</sub> back-up system, narrow version	U9043-0004			U9043-0002
LN <sub>2</sub> back-up system, narrow version	U9044-0004			U9044-0002
CO <sub>2</sub> back-up system, premium version	U9043-0008			U9043-0006
LN <sub>2</sub> back-up system, premium version	U9044-0008			U9044-0006

Power supply	International	UK/HKG	Australia	China	USA	Japan
CryoCube® F740, 740 L, left, 5 shelves, 100 V/60 Hz						F740000036
CryoCube® F740, 740 L, left, 5 shelves, 120 V/60 Hz					F740200035	
CryoCube® F740, 740 L, left, 5 shelves, 208 V/60 Hz					F740400035	
CryoCube® F740, 740 L, left, 5 shelves, 230 V/50 Hz	F740300031	F740300032	F740300033	F740300034		
CryoCube® F740, 740 L, left, 3 shelves, 100 V/60 Hz						F740000016
CryoCube® F740, 740 L, left, 3 shelves, 120 V/60 Hz					F740200015	
CryoCube® F740, 740 L, left, 3 shelves, 208 V/60 Hz					F740400015	
CryoCube® F740, 740 L, left, 3 shelves, 230 V/50 Hz	F740300011	F740300012	F740300013	F740300014		
CryoCube® F740i, 740 L, left, 5 shelves, 100 V/60 Hz						F740010036
CryoCube® F740i, 740 L, left, 5 shelves, 120 V/60 Hz					F740210035	
CryoCube® F740i, 740 L, left, 5 shelves, 208 V/60 Hz					F740410035	
CryoCube® F740i, 740 L, left, 5 shelves, 230 V/50 Hz	F740310031	F740310032	F740310033	F740310034		
CryoCube® F740i, 740 L, left, 3 shelves, 100 V/60 Hz						F740010016
CryoCube® F740i, 740 L, left, 3 shelves, 120 V/60 Hz					F740210015	
CryoCube® F740i, 740 L, left, 3 shelves, 208 V/60 Hz					F740410015	
CryoCube® F740i, 740 L, left, 3 shelves, 230 V/50 Hz	F740310011	F740310012	F740310013	F740310014		
CryoCube® F740iw, 740 L, left, 5 shelves, 100 V/60 Hz						F740010136
CryoCube® F740iw, 740 L, left, 5 shelves, 120 V/60 Hz					F740210135	
CryoCube® F740iw, 740 L, left, 5 shelves, 208 V/60 Hz					F740410135	
CryoCube® F740iw, 740 L, left, 5 shelves, 230 V/50 Hz	F740310131	F740310132	F740310133	F740310134		
CryoCube® F740iw, 740 L, left, 3 shelves, 100 V/60 Hz						F740010116
CryoCube® F740iw, 740 L, left, 3 shelves, 120 V/60 Hz					F740210115	
CryoCube® F740iw, 740 L, left, 3 shelves, 208 V/60 Hz					F740410115	
CryoCube® F740iw, 740 L, left, 3 shelves, 230 V/50 Hz	F740310111	F740310112	F740310113	F740310114		
CryoCube® F740hi, 740 L, left, 5 shelves, 100 V/60 Hz						F740020036
CryoCube® F740hi, 740 L, left, 5 shelves, 120 V/60 Hz					F740220035	
CryoCube® F740hi, 740 L, left, 5 shelves, 208 V/60 Hz					F740420035	
CryoCube® F740hi, 740 L, left, 5 shelves, 230 V/50 Hz	F740320031	F740320032	F740320033	F740320034		
CryoCube® F740hi, 740 L, left, 3 shelves, 100 V/60 Hz						F740020016
CryoCube® F740hi, 740 L, left, 3 shelves, 120 V/60 Hz					F740220015	
CryoCube® F740hi, 740 L, left, 3 shelves, 208 V/60 Hz					F740420015	
CryoCube® F740hi, 740 L, left, 3 shelves, 230 V/50 Hz	F740320011	F740320012	F740320013	F740320014		
CryoCube® F740iw, 740 L, left, 5 shelves, 100 V/60 Hz						F740020136
CryoCube® F740iw, 740 L, left, 5 shelves, 120 V/60 Hz					F740220135	
CryoCube® F740iw, 740 L, left, 5 shelves, 208 V/60 Hz					F740420135	
CryoCube® F740iw, 740 L, left, 5 shelves, 230 V/50 Hz	F740320131	F740320132	F740320133	F740320134		
CryoCube® F740hiw, 740 L, left, 3 shelves, 100 V/60 Hz						F740120116
CryoCube® F740hiw, 740 L, left, 3 shelves, 120 V/60 Hz					F740220115	
CryoCube® F740hiw, 740 L, left, 3 shelves, 208 V/60 Hz					F740420115	
CryoCube® F740hiw, 740 L, left, 3 shelves, 230 V/50 Hz	F740320111	F740320112	F740320113	F740320114		

## Order Numbers for Different Mains Voltage Versions

Power supply	International	UK/HKG	Australia	China	USA	Japan
CryoCube® F740, 740 L, right, 5 shelves, 100 V/60 Hz						F740000046
CryoCube® F740, 740 L, right, 5 shelves, 120 V/60 Hz					F740200045	
CryoCube® F740, 740 L, right, 5 shelves, 208 V/60 Hz					F740400045	
CryoCube® F740, 740 L, right, 5 shelves, 230 V/50 Hz	F740300041	F740300042	F740300043	F740300044		
CryoCube® F740, 740 L, right, 3 shelves, 100 V/60 Hz						F740000026
CryoCube® F740, 740 L, right, 3 shelves, 120 V/60 Hz					F740200025	
CryoCube® F740, 740 L, right, 3 shelves, 208 V/60 Hz					F740400025	
CryoCube® F740, 740 L, right, 3 shelves, 230 V/50 Hz	F740300021	F740300022	F740300023	F740300024		
CryoCube® F740i, 740 L, right, 5 shelves, 100 V/60 Hz						F740010046
CryoCube® F740i, 740 L, right, 5 shelves, 120 V/60 Hz					F740210045	
CryoCube® F740i, 740 L, right, 5 shelves, 208 V/60 Hz					F740410045	
CryoCube® F740i, 740 L, right, 5 shelves, 230 V/50 Hz	F740310041	F740310042	F740310043	F740310044		
CryoCube® F740i, 740 L, right, 3 shelves, 100 V/60 Hz						F740010026
CryoCube® F740i, 740 L, right, 3 shelves, 120 V/60 Hz					F740210025	
CryoCube® F740i, 740 L, right, 3 shelves, 208 V/60 Hz					F740410025	
CryoCube® F740i, 740 L, right, 3 shelves, 230 V/50 Hz	F740310021	F740310022	F740310023	F740310024		
CryoCube® F740hi, 740 L, right, 5 shelves, 100 V/60 Hz						F74002046
CryoCube® F740hi, 740 L, right, 5 shelves, 120 V/60 Hz					F740220045	
CryoCube® F740hi, 740 L, right, 5 shelves, 208 V/60 Hz					F740420045	
CryoCube® F740hi, 740 L, right, 5 shelves, 230 V/50 Hz	F740320041	F740320042	F740320043	F740320044		
CryoCube® F740hi, 740 L, right, 3 shelves, 100 V/60 Hz						F74002026
CryoCube® F740hi, 740 L, right, 3 shelves, 120 V/60 Hz					F740210125	
CryoCube® F740hi, 740 L, right, 3 shelves, 208 V/60 Hz					F740410125	
CryoCube® F740hi, 740 L, right, 3 shelves, 230 V/50 Hz	F740320021	F740320022	F740320023	F740320024		

Power supply	230 V, 50 Hz	120 V, 60 Hz	100 V, 60 Hz	100 V, 50 Hz
New Brunswick™ Innova® 40, 1.9 cm (3/4 in)	M1299-0082	M1299-0080	M1299-0081	M1299-0083
New Brunswick™ Innova® 40, 2.5 cm (1 in)	M1299-0092	M1299-0090	M1299-0091	M1299-0093
New Brunswick™ Innova® 40R, 1.9 cm (3/4 in)	M1299-0086	M1299-0084	M1299-0085	M1299-0087
New Brunswick™ Innova® 40R, 2.5 cm (1 in)	M1299-0096	M1299-0094	M1299-0095	M1299-0097
New Brunswick™ Innova® 42, 1.9 cm (3/4 in)	M1335-0002	M1335-0000	M1335-0001	M1335-0003
New Brunswick™ Innova® 42, 2.5 cm (1 in)	M1335-0012	M1335-0010	M1335-0011	M1335-0013
New Brunswick™ Innova® 42R, 1.9 cm (3/4 in)	M1335-0006	M1335-0004	M1335-0005	M1335-0007
New Brunswick™ Innova® 42R, 2.5 cm (1 in)	M1335-0016	M1335-0014	M1335-0015	M1335-0017
New Brunswick™ Innova® 43, 2.5 cm (1 in)	M1320-0002	M1320-0000	M1320-0001	M1320-0003
New Brunswick™ Innova® 43, 5.1 cm (2 in)	M1320-0012	M1320-0010	M1320-0011	M1320-0013
New Brunswick™ Innova® 43R, 2.5 cm (1 in)	M1320-0006	M1320-0004	M1320-0005	M1320-0007
New Brunswick™ Innova® 43R, 5.1 cm (2 in)	M1320-0016	M1320-0014	M1320-0015	M1320-0017
New Brunswick™ Innova® 44, 2.5 cm (1 in)	M1282-0002	M1282-0000	M1282-0001	M1282-0003
New Brunswick™ Innova® 44, 5.1 cm (2 in)	M1282-0012	M1282-0010	M1282-0011	M1282-0013
New Brunswick™ Innova® 44R, 2.5 cm (1 in)	M1282-0006	M1282-0004	M1282-0005	M1282-0007
New Brunswick™ Innova® 44R, 5.1 cm (2 in)	M1282-0016	M1282-0014	M1282-0015	M1282-0017
New Brunswick™ Innova® I26, 2.5 cm (1 in)	M1324-0002	M1324-0000		
New Brunswick™ Innova® I26R, 2.5 cm (1 in)	M1324-0006	M1324-0004	M1324-0005	
New Brunswick™ Excella® E24, 1.9 cm (3/4 in)	M1352-0002	M1352-0000	M1352-0001	
New Brunswick™ Excella® E24R, 1.9 cm (3/4 in)	M1352-0006	M1352-0004	M1352-0005	
New Brunswick™ Excella® E25, 2.5 cm (1 in)	M1353-0002	M1353-0000	M1353-0001	M1353-0003

Power supply	230 V, 50 Hz	230 V, 50/60 Hz	220/230 V, 50/60 Hz	230/240 V, 50/60 Hz	240 V, 50/60 Hz
New Brunswick™ Excella® E25, 2.5 cm (1 in)	M1353-0002	n.a.	n.a.	n.a.	n.a.
New Brunswick™ Excella® E25R, 2.5 cm (1 in)	M1353-0006	n.a.	n.a.	n.a.	n.a.
New Brunswick™ Innova® 2000, 1.9 cm (0.75 in)	n.a.	n.a.	M1190-0002	n.a.	M1190-0003
New Brunswick™ Innova® 2050, 1.9 cm (0.75 in)	n.a.	n.a.	M1190-0012	n.a.	M1190-0013
New Brunswick™ Innova® 2100, 1.9 cm (0.75 in)	n.a.	n.a.	M1194-0002	n.a.	M1194-0003
New Brunswick™ Innova® 2150, 1.9 cm (0.75 in)	n.a.	n.a.	M1194-0012	n.a.	M1194-0013
New Brunswick™ Innova® 2300, 2.5 cm (1 in)	n.a.	n.a.	M1191-0002	n.a.	M1191-0003
New Brunswick™ Innova® 2300, 5.1 cm (2 in)	n.a.	n.a.	M1191-0022	n.a.	M1191-0023
New Brunswick™ Innova® 2350, 2.5 cm (1 in)	n.a.	n.a.	M1191-0012	n.a.	M1191-0013
New Brunswick™ Innova® 2350, 5.1 cm (2 in)	n.a.	n.a.	M1191-0032	n.a.	M1191-0033
New Brunswick™ Innova® 5000, 5.1 cm (2 in)	n.a.	n.a.	M1196-0002	n.a.	M1196-0003
New Brunswick™ Innova® 5050 Rack System	n.a.	n.a.	*	M1232-0101	*
New Brunswick™ Innova® 5051 Rack Extension	n.a.	n.a.	*	M1232-0111	*

Power supply	100/120 V,					
	120 V, 60 Hz	120 V, 50/60 Hz	50/60 Hz	100 V, 60 Hz	100 V, 50 Hz	100 V, 50/60 Hz
New Brunswick™ Excella® E25, 2.5 cm (1 in)	M1353-0000			M1353-0001		
New Brunswick™ Excella® E25R, 2.5 cm (1 in)	M1353-0004			M1353-0005		
New Brunswick™ Innova® 2000, 1.9 cm (0.75 in)		M1190-0000				
New Brunswick™ Innova® 2050, 1.9 cm (0.75 in)		M1190-0010				M1190-0011
New Brunswick™ Innova® 2100, 1.9 cm (0.75 in)		M1194-0000				M1194-0001
New Brunswick™ Innova® 2150, 1.9 cm (0.75 in)		M1194-0010				M1194-0011
New Brunswick™ Innova® 2300, 2.5 cm (1 in)		M1191-0000				M1191-0001
New Brunswick™ Innova® 2300, 5.1 cm (2 in)		M1191-0020				M1191-0021
New Brunswick™ Innova® 2350, 2.5 cm (1 in)		M1191-0010				M1191-0011
New Brunswick™ Innova® 2350, 5.1 cm (2 in)		M1191-0030				M1191-0031
New Brunswick™ Innova® 5000, 5.1 cm (2 in)		M1196-0000				M1196-0001
New Brunswick™ Innova® 5050 Rack System			M1232-0100			
New Brunswick™ Innova® 5051 Rack Extension			M1232-0110			

# Order Numbers for Different Mains Voltage Versions

Power supply	International	UK/HKG	Australia	China	ROW
Galaxy® 170 R, Standard	C017301001	C017301002	C017301003	C017301004	C017201005
Galaxy® 170 R, 1 – 19 % O <sub>2</sub> Control	C017321001	C017321002	C017321003	C017321004	C017221005
Galaxy® 170 R, High-Temp Disinfection	C017311001	C017311002	C017311003	C017311004	C017211005
Galaxy® 170 R, High-Temp Disinfection, 4-Split Inner Door	C017314001	C017314002	C017314003	C017314004	C017214005
Galaxy® 170 R, High-Temp Disinfection, 1 – 19 % O <sub>2</sub> Control	C017331001	C017331002	C017331003	C017331004	C017231005
Galaxy® 170 R, High-Temp Disinfection, 1 – 19 % O <sub>2</sub> Control, 4-Split Inner Door	C017334001	C017334002	C017334003	C017334004	C017234005
Galaxy® 170 R, 4-Split Inner Door	C017304001	C017304002	C017304003	C017304004	C017204005
Galaxy® 170 R, 8-Split Inner Door	C017308001	C017308002	C017308003	C017304004	C017208005
Galaxy® 170 R, 1 – 19 % O <sub>2</sub> Control, 4-Split Inner Door	C017324001	C017324002	C017324003	C017324004	C017224005
Galaxy® 170 R, 1 – 19 % O <sub>2</sub> Control, 8-Split Inner Door	C017328001	C017328002	C017328003	C017328004	C017228005
Galaxy® 170 R, High-Temp Disinfection, 0.1 – 19 % O <sub>2</sub> Control	C017311041	C017311042	C017311043	C017311044	C017211045
Galaxy® 170 R, High-Temp Disinfection, 0.1 – 19 % O <sub>2</sub> Control, 4-Split Inner Door	C017314041	C017314042	C017314043	C017314044	C017214045
Galaxy® 170 R, High-Temp Disinfection, 0.1 – 19 % O <sub>2</sub> Control, 4-Split Inner Door, Copper Chamber	C017314051	C017314052	C017314053	C017314054	C017214055
Galaxy® 170 R, High-Temp Disinfection, 0.1 – 19 % O <sub>2</sub> Control, 4-Split Inner Door, Humidity Package	C017314061	C017314062	C017314063	C017314064	C017214065
Galaxy® 170 R, High-Temp Disinfection, 0.1 – 19 % O <sub>2</sub> Control, 8-Split Inner Door	C017318041	C017318042	C017318043	C017318044	C017218045
Galaxy® 170 R, High-Temp Disinfection, 1 – 19 % O <sub>2</sub> Control, Humidity Package	C017331011	C017331012	C017331013	C017331014	C017231015
Galaxy® 170 R, High-Temp Disinfection, 1 – 19 % O <sub>2</sub> Control, Copper Chamber	C017331021	C017331022	C017331023	C017331024	C017231015
Galaxy® 170 R, High-Temp Disinfection, 1 – 19 % O <sub>2</sub> Control, Humidity Package, Copper Chamber	C017331031	C017331032	C017331033	C017331034	C017231035
Galaxy® 170 R, High-Temp Disinfection, 1 – 19 % O <sub>2</sub> Control, 4-Split Inner Door, Humidity Package	C017334011	C017334012	C017334013	C017334014	C017234015
Galaxy® 170 R, High-Temp Disinfection, 1 – 19 % O <sub>2</sub> Control, 4-Split Inner Door, Copper Chamber	C017334021	C017334022	C017334023	C017334024	C017234025
Galaxy® 170 R, High-Temp Disinfection, 1 – 19 % O <sub>2</sub> Control, 4-Split Inner Door, Humidity Package, Copper Chamber	C017334031	C017334032	C017334033	C017334034	C017234035
Galaxy® 170 R, High-Temp Disinfection, 1 – 19 % O <sub>2</sub> Control, 8-Split Inner Door	C017338001	C017338002	C017338003	C017338004	C017238005
Galaxy® 170 R, High-Temp Disinfection, 1 – 19 % O <sub>2</sub> Control, 8-Split Inner Door, Humidity Package	C017338011	C017338012	C017338013	C017338014	C017238015
Galaxy® 170 R, High-Temp Disinfection, 1 – 19 % O <sub>2</sub> Control, 8-Split Inner Door, Humidity Package, Copper Chamber	C017338031	C017338032	C017338033	C017338034	C017238035
Galaxy® 170 R, High-Temp Disinfection, 1 – 95 % O <sub>2</sub> Control	C017311071	C017311072	C017311073	C017311074	C017211075
Galaxy® 170 R, High-Temp Disinfection, 1 – 95 % O <sub>2</sub> Control, 4-Split Inner Door	C017314071	C017314072	C017314073	C017314074	C017214075
Galaxy® 170 R, High-Temp Disinfection, 1 – 95 % O <sub>2</sub> Control, 4-Split Inner Door, Humidity Package	C017314091	C017314092	C017314093	C017314094	C017214095
Galaxy® 170 R, High-Temp Disinfection, 1 – 95 % O <sub>2</sub> Control, 4-Split Inner Door, Copper Chamber	C017314081	C017314082	C017314083	C017314084	C017214085
Galaxy® 170 R, High-Temp Disinfection, 1 – 95 % O <sub>2</sub> Control, 8-Split Inner Door	C017318071	C017318072	C017318073	C017318074	C017218075
Galaxy® 170 R, High-Temp Disinfection, Humidity Package	C017311011	C017311012	C017311013	C017311014	C017211015
Galaxy® 170 R, High-Temp Disinfection, Copper Chamber	C017311021	C017311022	C017311023	C017311024	C017211025
Galaxy® 170 R, High-Temp Disinfection, Humidity Package, Copper Chamber	C017311031	C017311032	C017311033	C017311034	C017211035
Galaxy® 170 R, High-Temp Disinfection, 4-Split Inner Door, Humidity Package	C017314011	C017314012	C017314013	C017314014	C017214015
Galaxy® 170 R, High-Temp Disinfection, 4-Split Inner Door, Copper Chamber	C017314021	C017314022	C017314023	C017314024	C017214025
Galaxy® 170 R, High-Temp Disinfection, 4-Split Inner Door, Humidity Package, Copper Chamber	C017314031	C017314032	C017314033	C017314034	C017214035
Galaxy® 170 R, High-Temp Disinfection, 8-Split Inner Door	C017318001	C017318002	C017318003	C017318004	C017218005
Galaxy® 170 R, High-Temp Disinfection, 8-Split Inner Door, Humidity Package	C017318011	C017318012	C017318013	C017318014	C017218015
Galaxy® 170 R, High-Temp Disinfection, 8-Split Inner Door, Humidity Package, Copper Chamber	C017318031	C017318032	C017318033	C017318034	C017218035

Power supply	International	UK/HKG	Australia	China	ROW
Galaxy® 170 S, Standard	C017101001	C017101002	C017101003	C017101004	C017001005
Galaxy® 170 S, High-Temp Disinfection	C017111001	C017111002	C017111003	C017111004	C017011005
Galaxy® 170 S, High-Temp Disinfection, 4-Split Inner Door	C017114001	C017114002	C017114003	C017114004	C017014005
Galaxy® 170 S, Standard, 4-Split Inner Door	C017104001	C017104002	C017104003	C017104004	C017004005

Power supply	International	UK/HKG	Australia	China	ROW
Galaxy® 48 R, Standard	C048300001	C048300002	C048300003	C048300004	C048200005
Galaxy® 48 R, 1 – 19 % O <sub>2</sub> Control	C048320001	C048320002	C048300003	C048320004	C048220005
Galaxy® 48 R, High-Temp Disinfection	C048310001	C048310002	C048310003	C048310004	C048210005
Galaxy® 48 R, High-Temp Disinfection, 1 – 19 % O <sub>2</sub> Control	C048330001	C048330002	C048330003	C048330004	C048230005
Galaxy® 48 R, High-Temp Disinfection, 2-Split Inner Door	C048312001	C048312002	C048312003	C048312004	C048212005
Galaxy® 48 R, High-Temp Disinfection, 0.1 – 19 % O <sub>2</sub> Control	C048310041	C048310042	C048310043	C048310044	C048210045
Galaxy® 48 R, High-Temp Disinfection, 0.1 – 19 % O <sub>2</sub> Control, Humidity Package	C048310061	C048310062	C048310063	C048310064	C048210065
Galaxy® 48 R, High-Temp Disinfection, 0.1 – 19 % O <sub>2</sub> Control, 2-Split Inner Door	C048312041	C048312042	C048312043	C048312044	C048212045
Galaxy® 48 R, High-Temp Disinfection, 0.1 – 19 % O <sub>2</sub> Control, 2-Split Inner Door, Humidity Package	C048312061	C048312062	C048312063	C048312064	C048212065
Galaxy® 48 R, High-Temp Disinfection, 1 – 19 % O <sub>2</sub> Control, 2-Split Inner Door	C048332001	C048332002	C048332003	C048332004	C048232005
Galaxy® 48 R, High-Temp Disinfection, 1 – 19 % O <sub>2</sub> Control, 2-Split Inner Door, Humidity Package	C048332011	C048332012	C048332013	C048332014	C048232015

Power supply	International	UK/HKG	Australia	China	ROW
New Brunswick™ S41i	S411230011	S411230012	S411230013	S411230014	S41120010

Power supply	International	UK/HKG	Australia	China	Japan	Argentina	Brazil	ROW
Innova® S44i, 2.5 cm (1 in) orbit, incubated, 2.5 cm (1 in)	S44I300001	S44I331002	S44I331003	S44I331004	S44I331006	S44I331008	S44I331009	S44I331005
Innova® S44i, 2.5 cm (1 in) orbit, refrigerated, 2.5 cm (1 in)	S44I310001	S44I331002	S44I331003	S44I331004	S44I331006	S44I331008	S44I331009	S44I331005
Innova® S44i, 2.5 cm (1 in) orbit, refrigerated, photosynthetic LED light bank, 2.5 cm (1 in)	S44I311001	S44I331002	S44I331003	S44I331004		S44I331008	S44I331009	S44I331005
Innova® S44i, 5.1 cm (2 in) orbit, incubated, 5.1 cm (2 in)	S44I320001	S44I331002	S44I331003	S44I331004	S44I331006	S44I331008	S44I331009	S44I331005
Innova® S44i, 5.1 cm (2 in) orbit, refrigerated, 5.1 cm (2 in)	S44I330001	S44I331002	S44I331003	S44I331004	S44I331006	S44I331008	S44I331009	S44I331005
Innova® S44i, 5.1 cm (2 in) orbit, refrigerated, photosynthetic LED light bank, 5.1 cm (2 in)	S44I331001	S44I331002	S44I331003	S44I331004		S44I331008	S44I331009	S44I331005

**ALBANIA\***

Eppendorf Austria GmbH  
Ignaz Köck Straße 10/2. OG  
1210 Wien  
AUSTRIA  
Tel: +43 (0) 1 890 13 64 - 0  
Fax: +43 (0) 1 890 13 64 - 20  
office@eppendorf.at  
www.eppendorf.at

**AUSTRALIA\***

Eppendorf South Pacific Pty. Ltd.  
Unit 4, 112 Talavera Road  
North Ryde, NSW 2113  
AUSTRALIA  
Tel.: +61 2 9889 5000  
Fax: +61 2 9889 5111  
Info@eppendorf.com.au  
www.eppendorf.com.au

**BAHRAIN\***

Eppendorf Middle East and Africa FZ-LLC  
P. O. Box 502019  
Al Thuraya Tower 1 / Office 901  
Media City, Dubai  
UNITED ARAB EMIRATES  
Tel: +971 4 369 29 54  
Fax: +971 4 368 82 60  
info-dubai@eppendorf.ae  
www.eppendorf.ae

**BELGIUM\***

Eppendorf Belgium N.V./S.A.  
Stationsstraat 180/4  
3110 Rotselaar  
BELGIUM  
Tel.: +32 1656 2831  
Fax: +32 1657 2753  
www.eppendorf.be  
Info-be@eppendorf.be

**BOTSWANA\***

Eppendorf Middle East and Africa FZ-LLC  
P. O. Box 502019  
Al Thuraya Tower 1 / Office 901  
Media City, Dubai  
UNITED ARAB EMIRATES  
Tel: +971 4 369 29 54  
Fax: +971 4 368 82 60  
info-dubai@eppendorf.ae  
www.eppendorf.ae

**BULGARIA\***

Eppendorf Austria GmbH  
Ignaz Köck Straße 10/2. OG  
1210 Wien  
AUSTRIA  
Tel: +43 (0) 1 890 13 64 - 0  
Fax: +43 (0) 1 890 13 64 - 20  
office@eppendorf.at  
www.eppendorf.at

**ALGERIA**

Eurl la Nouvelle Technologie de Santé (N.T.S)  
Coopérative Abbas Laghrour  
Bt B, No. 02  
16308 Kouba Alger  
ALGERIE.  
Tel :+ 213 (0) 21 29 87 52 / 75 /70  
Fax:+ 213 (0) 21 29 89 80  
email : nts-dz@hotmail.com

**AUSTRIA\***

Eppendorf Austria GmbH  
Ignaz Köck Straße 10/2. OG  
1210 Wien  
AUSTRIA  
Tel: +43 (0) 1 890 13 64 - 0  
Fax: +43 (0) 1 890 13 64 - 20  
office@eppendorf.at  
www.eppendorf.at

**BANGLADESH**

MBiologix  
House # 39 (4th Floor), Road # 14, Sector # 13  
Uttara Model Town  
Dhaka-1230  
Bangladesh  
Tel: +88-02-8933572  
Fax: +88-02-8933484  
sales@mbiologix.com

**BHUTAN\***

Eppendorf India Limited  
Plot No: 18, 19, 20 (Part)  
Sidco Industrial Estate (South Phase)  
Ambattur, Chennai 600 058  
INDIA  
Tel.: +91 44 66 31 22 00  
info@eppendorf.co.in  
www.eppendorf.co.in

**BRAZIL**

Eppendorf do Brasil Ltda.  
Rua Presidente Antônio Cândido, nº 80  
05083-060. Alto da Lapa – São Paulo  
BRAZIL  
Tel.: +55 11 3031 9044  
eppendorf@eppendorf.com.br  
www.eppendorf.com.br

**CAMBODIA**

DKSH Cambodia  
10, Street 240  
Chaktomuk, Daun Penh District  
Phnom Penh City  
Cambodia  
Phone: +855 23 218 670  
Fax: +855 23 990 410  
Sopheak.ngin@dksh.com.kh  
www.eurocontinents.com; www.dksh.com

**ANGOLA\***

Eppendorf Middle East and Africa FZ-LLC  
P. O. Box 502019  
Al Thuraya Tower 1 / Office 901  
Media City, Dubai  
UNITED ARAB EMIRATES  
Tel: +971 4 369 29 54  
Fax: +971 4 368 82 60  
info-dubai@eppendorf.ae  
www.eppendorf.ae

**AZERBAIJAN**

Donmex Trade s.r.o.  
Lipovska 463/4  
15521, Praha 5-Zlicin,  
Czech Republic  
donmextrade@yahoo.com

**BANGLADESH\***

Eppendorf India Limited  
Plot No: 18, 19, 20 (Part)  
Sidco Industrial Estate (South Phase)  
Ambattur, Chennai 600 058  
INDIA  
Tel.: +91 44 66 31 22 00  
info@eppendorf.co.in  
www.eppendorf.co.in

**BOSNIA-HERZEGOVINA\***

Eppendorf Austria GmbH  
Ignaz Köck Straße 10/2. OG  
1210 Wien  
AUSTRIA  
Tel: +43 (0) 1 890 13 64 - 0  
Fax: +43 (0) 1 890 13 64 - 20  
office@eppendorf.at  
www.eppendorf.at

**BRUNEI\***

Eppendorf Asia Pacific Sdn. Bhd.  
Suite 11.03 & 11.04, 11th Floor  
Menara HeiTech Village  
Persiaran Kewajipan USJ 1  
47600 Subang Jaya, Selangor Darul Ehsan  
MALAYSIA  
Tel.: +60 3 8023 2769  
Fax: +60 3 8023 3720  
eppendorf@eppendorf.com.my  
www.eppendorf.com.my

**CANADA\***

Eppendorf Canada Ltd.  
2810 Argentia Road, Unit # 2  
Mississauga, Ontario L5N 8L2  
CANADA  
Tel.: +1 800 263 8715  
+1 905 826 5525  
Fax: +1 905 826 5424  
canada@eppendorf.com  
www.eppendorf.ca

**CHINA\***

Eppendorf (Shanghai) International  
Trade Co., Ltd.  
17th Floor, You You International Plaza  
No. 76 Pu Jian Road  
Shanghai 200127, P.R. CHINA  
Tel.: +86 21 38560500  
Fax: +86 21 38560555  
market.info@eppendorf.cn  
www.eppendorf.cn

**CHINA\***

Eppendorf China Ltd.  
Hong Kong Office  
Unit 1801-05, Westin Centre  
26 Hung To Road, Kwun Tong, Kowloon  
HONG KONG SAR, P.R. CHINA  
Tel.: +852 3528 8900  
Fax: +852 3528 8980  
info@eppendorf.hk  
www.eppendorf.hk

**CZECH REPUBLIC\***

Eppendorf Czech & Slovakia s.r.o.  
Voděradská 2552/16  
251 01 Říčany u Prahy  
CZECH REPUBLIC  
Tel.: +420 323 605 454  
Eppendorf@eppendorf.cz  
www.eppendorf.cz

**EGYPT\*\***

Modern Bio-Systems  
349 Abdel Nasser str. Assafra  
Alexandria  
EGYPT  
Tel: +202 3550 7632  
Fax: +202 3550 7632  
mohamednasr@tedata.net.eg

**ETHIOPIA**

Eppendorf Middle East and Africa FZ-LLC  
P. O. Box 502019  
Al Thuraya Tower 1 / Office 901  
Media City, Dubai  
UNITED ARAB EMIRATES  
Tel: +971 4 369 29 54  
Fax: +971 4 368 82 60  
info-dubai@eppendorf.ae  
www.eppendorf.ae

**GERMANY\***

Eppendorf Vertrieb  
Deutschland GmbH  
Peter-Henlein-Straße 2  
50389 Wesseling-Berzdorf  
GERMANY  
Tel.: +49 2232 418-0  
Fax: +49 2232 418-155  
vertrieb@eppendorf.de  
www.eppendorf.de

**CHINA\***

Eppendorf (Shanghai) International  
Trade Co., Ltd., Beijing Office  
Unit D12-D15, 11F, Tower 1, Xihuan Plaza,  
No.1 Xizhimenwai Street  
Xicheng District, Beijing 100044, P.R. CHINA  
Tel.: +86 10 8836 0998  
Fax: +86 10 8836 0501  
market.info@eppendorf.cn  
www.eppendorf.cn

**CROATIA\***

Eppendorf Austria GmbH  
Ignaz Köck Straße 10/2. OG  
1210 Wien  
AUSTRIA  
Tel: +43 (0) 1 890 13 64 - 0  
Fax: +43 (0) 1 890 13 64 - 20  
office@eppendorf.at  
www.eppendorf.at

**DENMARK\***

Eppendorf Nordic A/S  
Slotsmarken 12  
2970 Horsholm  
DENMARK  
Tel.: +45 43 24 00 00  
nordic@eppendorf.dk  
www.eppendorf.dk

**EGYPT\*\***

United Scientific Equipment  
24 Elsobky street, Dokki  
Giza  
EGYPT  
Tel: +202 33367880  
Fax: +202 37613211  
cleobio@link.net

**FINLAND\***

Eppendorf Nordic A/S  
Slotsmarken 12  
2970 Horsholm  
DENMARK  
Tel.: +358 9 88 171 305  
nordic@eppendorf.dk  
www.eppendorf.dk

**GHANA\***

Eppendorf Middle East and Africa FZ-LLC  
P. O. Box 502019  
Al Thuraya Tower 1 / Office 901  
Media City, Dubai  
UNITED ARAB EMIRATES  
Tel: +971 4 369 29 54  
Fax: +971 4 368 82 60  
info-dubai@eppendorf.ae  
www.eppendorf.ae

**CHINA\***

Eppendorf China Ltd.  
Guangzhou Office  
Room 2006-07, Tower B, China Int'l Center  
No.33 Zhong Shan San Road  
Guangzhou 510055, P.R.China  
Tel.: +86 20 8375 4160  
Fax: +86 20 8385 4130  
market.info@eppendorf.cn  
www.eppendorf.cn

**CYPRUS\***

Eppendorf Austria GmbH  
Ignaz Köck Straße 10/2. OG  
1210 Wien  
AUSTRIA  
Tel: +43 (0) 1 890 13 64 - 0  
Fax: +43 (0) 1 890 13 64 - 20  
office@eppendorf.at  
www.eppendorf.at

**EGYPT**

Trust Medical SAE  
28, Israa St. Moallemin  
Giza, Cairo  
EGYPT  
Tel: +20 233051544, +20 233051543  
Fax: +20 233447333  
t.medicaltme@gmail.com

**ESTONIA**

Quantum Eesti AS  
Saekoja 36a  
50107 Tartu  
ESTONIA  
Tel.: +372 7 301320  
Fax: +372 7 304 310  
quantum@quantum.ee  
www.quantum.ee

**FRANCE\***

EPPENDORF FRANCE SAS  
2/6 rue du Château d'Eau  
78360 Montesson  
FRANCE  
Tel.: +33 1 30 15 67 40  
Fax: +33 1 30 15 67 45  
eppendorf@eppendorf.fr  
www.eppendorf.fr

**GREECE\***

Eppendorf Austria GmbH  
Ignaz Köck Straße 10/2. OG  
1210 Wien  
AUSTRIA  
Tel: +43 (0) 1 890 13 64 - 0  
Fax: +43 (0) 1 890 13 64 - 20  
office@eppendorf.at  
www.eppendorf.at



**HONG KONG SAR\***

Eppendorf China Ltd.  
Hong Kong Office  
Unit 1801-05, Westin Centre  
26 Hung To Road, Kwun Tong, Kowloon  
HONG KONG SAR, P.R. CHINA  
Tel.: +852 3528 8900  
Fax: +852 3528 8980  
info@eppendorf.hk  
www.eppendorf.hk

**INDIA\***

Eppendorf India Limited  
Plot No: 18, 19, 20 (Part)  
Sidco Industrial Estate (South Phase)  
Ambattur, Chennai 600 058  
INDIA  
Tel.: +91 44 66 31 22 00  
info@eppendorf.co.in  
www.eppendorf.co.in

**INDONESIA\*\***

PT GaiaScience Indonesia  
Kirana Boutique Office Blok D3 No. 3  
Jl. Boulevard Raya No. 1  
Kelapa Gading, Jakarta 14240  
INDONESIA  
Tel.: +62 21 4586 0646  
Fax.: +62 21 4586 0645  
info@gaiascience.co.id  
www.gaiascience.co.id

**IRAQ\*\***

IFAA Medical Ltd.  
Palestine Street 48,  
Baghdad  
IRAQ  
Tel.: +964 7700 831026  
Fax: +964 1717 2383  
info@IFaa-Med.Net

**ISRAEL\*\***

Bio-Instrument Jerusalem Ltd.  
3 Dahomey Street,  
Jerusalem 96587  
ISRAEL  
Tel.: +972 2 6416419  
Fax: +972 26438149  
bioinstj@zahav.net.il

**JORDAN**

A.M.S.A.  
Arab Medical & Scientific Alliance  
P.O. Box 2509  
11953 Tela' Al-Ali  
Amman, JORDAN  
Tel.: +962 6 552 8009-13  
Fax: +962 6 553 2358  
amsa@amsa.com.jo

**HUNGARY\***

Eppendorf Austria GmbH  
Ignaz Köck Straße 10/2. OG  
1210 Wien  
Austria  
Tel.: +43 1 890 3 64 0  
Fax: +43 1 890 3 64 20  
Mobil: +36 20 532 86 97  
bosze.z@eppendorf.at  
www.eppendorf.hu

**INDONESIA\***

PT Infiniti Bioanalitika Solusindo  
Rukan Grand Aries Niaga  
Blok A1. No. 1N  
Jl Taman Airies  
Jakarta Barat 11620  
Indonesia  
Phone: +62 21 5870 361  
Fax: +62 21 5890 6884  
sales@ibs.co.id  
www.ibs.co.id

**IRAN**

Tadjhiz Gostar Co.  
No. 168 Taleghani Ave.  
P. O. Box 14335 - 153  
P.C. 14178 Tehran  
IRAN  
Tel.: +98 21 6649-8684  
Fax: +98 21 6649-5098  
info@tadjhizgostar.com  
www.tadjhizgostar.com

**IRELAND (Republic)\***

Eppendorf UK Limited  
Eppendorf House  
Gateway 1000 Whittle Way  
Arlington Business Park  
Stevenage SG1 2FP, UNITED KINGDOM  
Tel.: +44 1438 735 888  
Fax: +44 1438 735 889  
sales@eppendorf.co.uk  
www.eppendorf.co.uk

**ITALY\***

Eppendorf s.r.l.  
Via Zante 14  
20138 Milano  
ITALY  
Tel.: +390 2 55 404 1  
Fax: +390 2 58 013 438  
eppendorf@eppendorf.it  
www.eppendorf.it

**JORDAN**

Al-Fursan For Medical Supplies  
Tla'a Ali , AL-Musleh Center,  
Building # 178, Office # 13 , 1st floor  
Amman, JORDAN  
Tel.: +962 6 5330352  
Fax: +962 6 5338352  
m.dweik@fursan-med.com

**ICELAND\***

Eppendorf Nordic A/S  
Slotsmarken 12  
2970 Horsholm  
DENMARK  
Tel.: +45 43 24 00 00  
nordic@eppendorf.dk  
www.eppendorf.dk

**INDONESIA\*\***

PT ITS Science Indonesia  
Sentra Bisnis Artha Gading  
Block A6-A, No. 3 & 5  
Jl Boulevard Artha Gading, Kelapa Gading  
Jakarta 14240; INDONESIA  
Tel.: +62 21 451 6222  
Fax.: +62 21 451 6223  
info@its-indonesia.com  
www.its-indonesia.com

**IRAQ**

Tiba Pharm for Exporting, Trading and Distributing  
Medicines and Medical Appliance  
Mob: +201 003333444  
vceo@haliraia.com  
Represented in Iraq by:  
Alkhadraa Scientific Bureau  
Hay Sanaa, Basrah, IRAQ  
Mob: +964 7901941943  
alkhadraacompany@gmail.com

**ISRAEL**

Lumitron Ltd.  
17 Hamefalsim St. Kiryat Arye  
Petah-Tikva 49514  
ISRAEL  
Tel.: +972 73 2000777  
Fax: +972 73 2000763  
lumitron@lumitron.co.il  
www.lumitron.co.il

**JAPAN\***

Eppendorf Co., Ltd.  
Horisho Building  
Higashi-Kanda 2-4-5, Chiyoda-ku  
Tokyo 101-0031  
JAPAN  
Tel.: +81 3 5825 2361  
Fax: +81 3 5825 2365  
info@eppendorf.jp  
www.eppendorf.com/jp

**JORDAN**

Al-Faiha for Laboratories & Scientific Supplies  
W.L.L.  
Al-Sayegh Commercial Centre Building No. 163  
F11  
King Hussein Street, Abdali  
P.O.Box: 926209  
Amman 11190 Jordan  
Tel: +962 6 465 9609, 4633290- Ext 105  
Fax: +962 6 463 3295  
noor@sahoury.com

**KAZAKHSTAN**

VELD Ltd.  
Seifullina str., 410  
48004 Almaty  
KAZAKHSTAN  
Tel.: +7 3272 952270  
Fax: +7 3272 796723  
info@veld.kz  
www.veld.kz

**KOSOVO\***

Eppendorf Austria GmbH  
Ignaz Köck Straße 10/2. OG  
1210 Wien  
AUSTRIA  
Tel: +43 (0) 1 890 13 64 - 0  
Fax: +43 (0) 1 890 13 64 - 20  
office@eppendorf.at  
www.eppendorf.at

**LAOS**

New Link Lao Sole Co., Ltd  
Technology Solutions  
Nakhouay Road Unit 2 Baan  
Khamsavath Saysettha District  
Vientiane  
Lao PDR  
Phone: +856 20 555 18174  
Newlinklaosts.dir@gmail.com

**LEBANON\*\***

IV LAB S.A.R.L.  
Baouchrieh-Industrial City-St. Jean center,  
2nd floor, Beirut  
LEBANON  
Tel.: +961 3 962530  
Fax: +961 1 875792  
tony.hkayem@ivlab-leb.com

**LUXEMBOURG\***

Eppendorf Belgium N.V./S.A.  
Stationsstraat 180/4  
3110 Rotselaar  
BELGIUM  
Tel.: +32 1656 2831  
Fax: +32 1657 2753  
info@eppendorf.be  
www.eppendorf.be

**MALAWI\***

Eppendorf Middle East and Africa FZ-LLC  
P. O. Box 502019  
Al Thuraya Tower 1 / Office 901  
Media City, Dubai  
UNITED ARAB EMIRATES  
Tel: +971 4 369 29 54  
Fax: +971 4 368 82 60  
info-dubai@eppendorf.ae  
www.eppendorf.ae

**KENYA**

F & S Scientific Ltd  
Shamneel Court, 2 Muthithi Road, Westlands  
P.O. Box 39081-00623  
Nairobi, KENYA  
Tel: +254 20 3594777  
Fax: +254 20 4449633  
mail@fnscientific.com  
www.fnscientific.com

**KUWAIT**

Central Circle Co.  
P.O. Box 1015  
Salmieh, 22011  
Salmieh  
KUWAIT  
Tel.: +965 2 241 1758/1748  
Fax: +965 2 244 5457  
cencico@centralcircleco.com

**LATVIA**

SIA Quantum Latvia  
Balta iela 3/9  
Riga LV1055  
LATVIA  
Tel.: +371 747 29 26  
Fax: +371 747 29 39  
anna@quantum.lv  
www.quantum.lv

**LIBYA**

El-Shamela Health Care Co.  
ElHawary Road behind old Agricultural  
Police Station, EL Hawary Zone  
P.O. 15412 EL Kish  
Benghazi- LIBYA  
Tel.: + 218 61 223 1271  
Fax: + 218 61 223 1271  
tarik@swedik.com  
www.shamelahealth.com

**MACEDONIA\***

Eppendorf Austria GmbH  
Ignaz Köck Straße 10/2. OG  
1210 Wien  
AUSTRIA  
Tel: +43 (0) 1 890 13 64 - 0  
Fax: +43 (0) 1 890 13 64 - 20  
office@eppendorf.at  
www.eppendorf.at

**MALAYSIA\***

Eppendorf Asia Pacific Sdn. Bhd.  
Suite 11.03 & 11.04, 11th Floor  
20138 Milano  
Menara HeiTech Village  
Persiaran Kewajipan USJ 1  
47600 Subang Jaya, Selangor Darul Ehsan  
MALAYSIA  
Tel.: +60 3 8023 2769  
Fax: +60 3 8023 3720  
eppendorf@eppendorf.com.my  
www.eppendorf.com.my

**KENYA\*\***

SWAMA  
6th Floor, Tausi court, Tausi Road, off Muthithi  
Road, Westlands,  
P.O. Box 10256-00400  
Nairobi  
KENYA  
Tel: +254 20 3741242  
Fax: + 254 20 3742033  
swama@africaonline.co.ke

**LATIN AMERICA\***

Eppendorf do Brasil Ltda.  
Rua Presidente Antônio Cândido, nº 80  
05083-060. Alto da Lapa – São Paulo  
BRAZIL  
Tel.: +55 11 3031 9044  
eppendorf@eppendorf.com.br  
www.eppendorf.com.br

**LEBANON**

Tamer Frères s.a.l.  
Tamer Bldgs  
Jean Tamer Street  
Sin El Fil  
P.O.Box 84  
Beirut  
LEBANON  
Tel.: +961 1 499 846+847  
Fax: +961 1 510 233+234  
elie.gerges@tamer-group.com

**LITHUANIA**

GRIDA UAB  
Molėtų g. 16  
Didžioji Riešė  
14260 Vilniaus r.  
LITHUANIA  
Tel.: +370 5 2469435  
Fax: +370 5 2469436  
Labor@grida.lt  
www.grida.lt

**MADAGASKAR\***

Eppendorf Middle East and Africa FZ-LLC  
P. O. Box 502019  
Al Thuraya Tower 1 / Office 901  
Media City, Dubai  
UNITED ARAB EMIRATES  
Tel: +971 4 369 29 54  
Fax: +971 4 368 82 60  
info-dubai@eppendorf.ae  
www.eppendorf.ae

**MALTA\***

Eppendorf s.r.l.  
Via Zante 14  
20138 Milano  
ITALY  
Tel.: +390 2 55 404 1  
Fax: +390 2 58 013 438  
eppendorf@eppendorf.it  
www.eppendorf.it

**MAURITIUS\***

Eppendorf Middle East and Africa FZ-LLC  
P. O. Box 502019  
Al Thuraya Tower 1 / Office 901  
Media City, Dubai  
UNITED ARAB EMIRATES  
Tel: +971 4 369 29 54  
Fax: +971 4 368 82 60  
info-dubai@eppendorf.ae  
www.eppendorf.ae

**MOROCCO**

Scientific Supplies S.A.R.L  
12 ,Rue Sabri Boujemma,  
Casablanca  
MOROCCO  
Phone : (00212) 6 77 86 34 91  
Fax: (00212) 5 22 85 50 84  
sk@s-s.ma

**MYANMAR**

Okkar Thiri Company Limited  
No. 4(A), Pyay Road  
Hlaing Township, Yangon  
MYANMAR  
Tel.: +95 1 524 330  
Fax.: +95 1 505 209  
sales@okkarthiri.com  
www.okkarthiri.com

**NETHERLANDS\***

Eppendorf Nederland B.V.  
Kerkenbos 1101  
6546 BC Nijmegen  
P.O. Box 6826  
6503 GH Nijmegen, NETHERLANDS  
Tel.: +31 24 3717 600  
Fax: +31 24 3717 640  
info@eppendorf.nl  
www.eppendorf.nl

**NIGERIA**

Inqaba Biotechnical Industries (Pty) Ltd.  
P.O. Box 14356, Hatfield 0028  
Pretoria, South Africa  
Tel.: +27 12 343 5829  
Fax: +27 86 677 8409  
info@inqababiotec.co.za  
www.inqababiotec.co.za

**OMAN\*\***

Emphor FZCO  
P.O.Box: 61232  
Al Quos Industrial Area 3  
(Behind Al Quos Oasis Centre)  
Warehouse # 5, Dubai,  
UNITED ARAB EMIRATES  
Tel.: +971 43392603  
Fax: +971 4 8830133  
nilesh@emphor.biz

**MOLDOVA\***

Eppendorf Austria GmbH  
Ignaz Köck Straße 10/2. OG  
1210 Wien  
AUSTRIA  
Tel: +43 (0) 1 890 13 64 - 0  
Fax: +43 (0) 1 890 13 64 - 20  
office@eppendorf.at  
www.eppendorf.at

**MOROCCO\*\***

CHROMA-LAB S.A.R.L  
Residence Azaitouna  
32, Rue Al Banafsej  
Mers Sultan  
Casablanca, MOROCCO  
Tel.: +212 522 27 35 14  
Fax: +212 522 27 35 31  
chroma\_lab@yahoo.fr

**NAMIBIA\***

Eppendorf Middle East and Africa FZ-LLC  
P. O. Box 502019  
Al Thuraya Tower 1 / Office 901  
Media City, Dubai  
UNITED ARAB EMIRATES  
Tel: +971 4 369 29 54  
Fax: +971 4 368 82 60  
info-dubai@eppendorf.ae  
www.eppendorf.ae

**NEW ZEALAND\***

Eppendorf South Pacific Pty. Ltd.  
Unit 4, 112 Talavera Road  
North Ryde, NSW 2113  
AUSTRALIA  
Tel.: +61 2 9889 5000  
Fax: +61 2 9889 5111  
Info@eppendorf.com.au  
www.eppendorf.com.au

**NORWAY\***

Eppendorf Norge AS  
Forskningsparken  
Gaustadalleen 21  
0349 Oslo  
Norway  
Tel.: +47 22 56 66 32  
nordic@eppendorf.dk  
www.eppendorf.dk

**OMAN**

Muscat Pharmacy & Stores LLC  
Street No. 144, Building No: 51  
Off Al Bustan Road  
Al Wadi Al Kabir, Muscat  
SULTANATE OF OMAN  
Tel.: +968 24814501  
Fax: +968 24815201/ 202  
nibin@mpmct.com

**MONTENEGRO\***

Eppendorf Austria GmbH  
Ignaz Köck Straße 10/2. OG  
1210 Wien  
AUSTRIA  
Tel: +43 (0) 1 890 13 64 - 0  
Fax: +43 (0) 1 890 13 64 - 20  
office@eppendorf.at  
www.eppendorf.at

**MOZAMBIQUE\***

Eppendorf Middle East and Africa FZ-LLC  
P. O. Box 502019  
Al Thuraya Tower 1 / Office 901  
Media City, Dubai  
UNITED ARAB EMIRATES  
Tel: +971 4 369 29 54  
Fax: +971 4 368 82 60  
info-dubai@eppendorf.ae  
www.eppendorf.ae

**NEPAL**

Everest Trading Centre  
GPO Box No 8975 EPC 1467  
Kathmandu  
NEPAL  
Tel.: +977 1 4783 416  
Fax: +977 1 478 7734  
rajan.bista@hotmail.com

**NIGERIA**

Eppendorf Middle East and Africa FZ-LLC  
P. O. Box 502019  
Al Thuraya Tower 1 / Office 901  
Media City, Dubai  
UNITED ARAB EMIRATES  
Tel: +971 4 369 29 54  
Fax: +971 4 368 82 60  
info-dubai@eppendorf.ae  
www.eppendorf.ae

**OMAN**

Mustafa Sultan  
Science & Industry Co. L.L.C.  
Way No. 3503, Building No. 241, Al-Khuwair  
Muscat  
SULTANATE OF OMAN  
Tel.: +968 24636000  
Fax: +968 24479066  
r-menon@mustafasultan.com  
www.mustafasultan.com

**PAKISTAN\***

Eco Biosciences  
1st Floor, 109-W, Sardar Begum Plaza  
Blue Area  
Islamabad  
PAKISTAN  
Tel.: +92 51 234 851 59  
Fax: +92 51 234 85 20  
info@ecobiosciences.com  
www.ecobiosciences.com

**PAKISTAN\*\***

H. A. Shah & Sons  
3rd Floor, 109-W, Sardar Begum Plaza  
Jinnah Avenue, Blue Area  
Islamabad  
PAKISTAN  
Tel.: +92 51 227 3557  
Fax: +92 51 227 2743  
info@hashah.com  
www.hashah.com

**PHILIPPINES**

PHILAB Industries, Inc.  
8/ Hanjin Bldg. 1128 University  
Parkway Drive  
Bonifacio Global City, Taguig City 1634  
Philippines  
Phone: +63 2 551 9614  
Fax: +63 2 897 7732  
info@philab.com  
www.philab.com

**QATAR**

Gulfmed Medical Supplies  
Zone:7 Al Merqap Alqadeem  
St no : 109 Gabr Bin Mohamed  
Building no :14, Floor no :1 office no:5&6  
Doha/ QATAR  
Tel.: +974 44866216  
Fax: +974 44878546  
sales@gulfmedqatar.com  
www.gulfdrug.com

**RUSSIA\***

Eppendorf Russia LLC  
Derbenevskaya quay, 11  
Business Center POLLARS  
Office B 301  
Moscow 115114  
Russia  
Tel: +7 495 743 51 23  
Fax: +7 495 741 51 22  
info@eppendorf.ru

**SAUDI ARABIA**

Medicare Drug Store Company  
P.O.Box 9295  
Al Hamra  
Al Andulus Street  
Sharp Building  
Jeddah 21413, SAUDI ARABIA  
Tel.: +966 2 663 1864  
Fax: +966 2 660 9533  
info@medicare.com.sa

**SAUDI ARABIA**

GT Medical  
Rawdah District  
Prince Saudi AlFaisal St.  
Omnia Center, Office # 215  
Jeddah – Saudi Arabia  
Tel: +966 2 261 9222 / +966 2 261 9232 /  
+966 2 261 9300  
www.gtmedical.com

**PAKISTAN\*\***

INSTECH  
428-4th Floor, Mashriq Centre  
Sir Shah Mohammed Suleman Road, Block-14,  
Gulshan-e-Iqbal, Karachi-75300  
PAKISTAN  
Tel. +92 21 494 5487  
Fax +92 21 412 5992  
instech@cyber.net.pk

**POLAND\***

Eppendorf Poland Sp.z o.o  
Al. Jerozolimskie 212  
02-486 Warszawa  
POLAND  
Tel. +48 22 571 40 20  
Fax +48 22 571 40 30  
info@eppendorf.pl  
www.eppendorf.pl

**QATAR\*\***

Petro Emphor Co. W.L.L  
Bldg.# 314, New Salata Area,  
P.O.Box. No. 31822,  
D' ring Rd, Doha,  
QATAR  
Tel.: +974 44654563  
Fax: +974 44652256  
petroemphor@emphor.biz  
www.emphorlas.biz

**RWANDA\***

Eppendorf Middle East and Africa FZ-LLC  
P. O. Box 502019  
Al Thuraya Tower 1 / Office 901  
Media City, Dubai  
UNITED ARAB EMIRATES  
Tel: +971 4 369 29 54  
Fax: +971 4 368 82 60  
info-dubai@eppendorf.ae  
www.eppendorf.ae

**SAUDI ARABIA\*\***

Bayouni Trading Co. Ltd.  
Riyadh street, cross 21/22  
Thouqbah district  
Al-Khobar- 31952  
SAUDI ARABIA  
Tel.: +9663-8987188- Ext#: 300  
Fax : +9663-8645171  
Email: shams@bayouni.com

**SAUDI ARABIA\*\***

Naizak Global Engineering Systems  
Lab Systems Division  
PO Box 57792  
Riyadh 11584  
SAUDI ARABIA  
Tel.: + 966 1 4161161  
Fax: + 966 1 4633326  
awadma@naizak.com  
www.naizak.com

**PALESTINE**

M S S  
Medical Supplies & Services Co. Ltd.  
Palestinian Authority Territory  
P.O. Box 1909  
Ramallah  
PALESTINE  
Tel.: +972 2 295 9372-4  
Fax: +972 2 295 9375  
info@msspal.com

**PORTUGAL\***

Eppendorf Ibérica S.L.U.  
Avenida Tenerife 2  
Edificio 1  
28703 San Sebastián de los Reyes  
Madrid, SPAIN  
Tel.: +34 91 651 76 94  
Fax: +34 91 651 81 44  
eppendorf-portugal@eppendorf.pt  
www.eppendorf.pt

**ROMANIA\***

Eppendorf Austria GmbH  
Ignaz Köck Straße 10/2. OG  
1210 Wien  
AUSTRIA  
Tel: +43 (0) 1 890 13 64 - 0  
Fax: +43 (0) 1 890 13 64 - 20  
office@eppendorf.at  
www.eppendorf.at

**SERBIA\***

Eppendorf Austria GmbH  
Ignaz Köck Straße 10/2. OG  
1210 Wien  
AUSTRIA  
Tel: +43 (0) 1 890 13 64 - 0  
Fax: +43 (0) 1 890 13 64 - 20  
office@eppendorf.at  
www.eppendorf.at

**SAUDI ARABIA\*\***

Attieh Medico Ltd.  
Abdullah M. Al Khalifi St.  
Al Nakheel Dist. II  
PO Box 116105, Jeddah 21391  
Jeddah (East) 21391  
SAUDI ARABIA  
Tel.: +966 2 2864707  
Fax: +966 2 2864744  
rajeev@attiehmedico.com

**SAUDI ARABIA\*\***

DAFCO (Dar Al-Farabi for Medical Supplies)  
DAFCO Building, Imam Moh'd bin Saud St.  
P.O Box 67386 Riyadh 11596  
SAUDI ARABIA  
Tel +966 1 20 33 404 Ext 222  
Fax+966 1 20 74 652  
Mob +966 50 557 7837  
hisham@dafco-sa.com

**SINGAPORE**

AITBIOTECH Pte Ltd  
25 Pandan Crescent # 05-15  
TIC TECH Centre  
SINGAPORE 128477  
Tel.: +65 6778 6822  
Fax.: +65 6778 2962  
sales@aitbiotech.com  
www.aitbiotech.com

**SLOVAKIA\***

Eppendorf Czech & Slovakia s.r.o. – organizačná zložka  
Prírodovedecká fakulta UK v Bratislave  
Mlynská dolina  
842 15 Bratislava  
SLOVAKIA  
Tel.: +421 911 181 474  
eppendorf@eppendorf.sk  
www.eppendorf.sk

**SOUTH AFRICA**

Analytical Solutions  
370 Angus Crescent,  
Northlands Business Park,  
29 Newmarket Road,  
Northriding, Randburg, 2169  
SOUTH AFRICA  
Tel.: +27 (0)87 610 0900  
Fax: +27 (0)11 704 7713  
info@analyticalsolutions.co.za  
www.analyticalsolutions.co.za

**SPAIN\***

Eppendorf Ibérica S.L.U.  
Avenida Tenerife 2  
Edificio 1  
28703 San Sebastián de los Reyes  
Madrid, SPAIN  
Phone: +34 91 651 76 94  
Tel.: +34 91 651 76 94  
Fax: +34 91 651 81 44  
eppendorf@eppendorf.es  
www.eppendorf.es

**SWEDEN\***

Eppendorf Nordic A/S  
Slotsmarken 12  
2970 Horsholm  
DENMARK  
Tel.: +46 8 222 970  
nordic@eppendorf.dk  
www.eppendorf.dk

**SYRIA**

Millennium Technologies Inc.  
Khalid Bin El-Walid Str.  
P. O. Box 8099  
Damascus  
SYRIA  
Tel.: +963 11 2240519  
Fax: +963 11 2237059  
sk@mt-sy.net  
www.milltech-sy.com

**SINGAPORE**

VWR Singapore Pte Ltd.  
18 Gul Drive  
Singapore 629468  
SINGAPORE  
Tel.: +65 6505 0760  
Fax: +65 6264 3780  
sales@sg.vwr.com  
www.vwr.com

**SLOVENIA\***

Eppendorf Austria GmbH  
Ignaz Köck Straße 10/2. OG  
1210 Wien  
AUSTRIA  
Tel: +43 (0) 1 890 13 64 - 0  
Fax: +43 (0) 1 890 13 64 - 20  
office@eppendorf.at  
www.eppendorf.at

**SOUTH AFRICA**

Inqaba Biotechnical Industries (Pty) Ltd.  
PO Box 14356, Hatfield 0028  
Pretoria, South Africa  
Tel: +27 12 343 5829  
Fax: +27 86 677 8409  
Email: info@inqababiotec.co.za  
www.inqababiotec.co.za

**SRI LANKA**

Photon Technologies (Pvt) Ltd.  
71/A, Welikada Watte Road  
Rajagiriy, Colombo  
Sri Lanka  
Phone: +94 11 286 23 59  
Tel.: +94 11 937 83 98  
Fax: +94 71 937 83 98  
sales@photonlk.com

**SWITZERLAND\***

Vaudaux-Eppendorf AG  
Im Kirschgarten 30  
4124 Schönenbuch  
SWITZERLAND  
Tel.: +41 61 482 1414  
Fax: +41 61 482 1419  
eppendorf@eppendorf.ch  
www.eppendorf.ch

**TAIWAN**

Yu Shing Bio-tech Co., Ltd.  
7F.-2, No. 141, Sec. 2, Heping W. Rd.,  
Zhongzheng Dist.  
Taipei City 100,  
Taiwan (R.O.C.)  
Phone: +886 2100 1008  
Fax: +886 2 2522 1018  
service@yu-shing.com.tw  
www.yu-shing.com.tw/catalog/

**SINGAPORE\*\***

ITS Science & Medical Pte Ltd  
219, Henderson Road  
#11 02 Henderson Industrial Park  
Singapore 159556  
Tel.: +65 6273 0898  
Fax.: +65 6273 0810  
info@its-sciencemedical.com  
www.its-sciencemedical.com

**SOUTH AFRICA**

Merck (Pty) Ltd  
1 Friesland Drive  
Longmeadow Business Estate  
Modderfontein, 1645  
SOUTH AFRICA  
Tel.: +27 11 3725129  
Fax: +27 11 3725398  
adele.heath@merckgroup.com  
www.merckmillipore.com

**SOUTH KOREA\***

Eppendorf Korea Ltd.  
Gala Tower 10F  
46, Nonhyeon-ro 85-gil,  
Gangnam-gu, Seoul, 06235  
SOUTH KOREA  
Tel.: +82 1577 4395  
Fax: +82 2 2190 7799  
cs@eppendorf.kr  
www.eppendorf.kr

**SOUTH SUDAN\***

Eppendorf Middle East and Africa FZ-LLC  
P. O. Box 502019  
Al Thuraya Tower 1 / Office 901  
Media City, Dubai  
UNITED ARAB EMIRATES  
Tel: +971 4 369 29 54  
Fax: +971 4 368 82 60  
info-dubai@eppendorf.ae  
www.eppendorf.ae

**SYRIA**

Medical Business Center - MBC  
Al Ward Street , Bldg. 7  
P. O. Box 30589  
Damascus  
SYRIA  
Tel.: +963 11 23 22 301  
Fax: +963 11 23 17 555  
info@mbc-lab.com  
www.mbc-lab.com

**TAIWAN**

Flamegold Material Corporation  
No. 335-9, Sec. 1, Wenhua 2nd Rd.  
Linkou Dist.  
New Taipei City 244  
Taiwan (R.O.C.)  
Phone: +886 2 2609 8982  
Fax: +886 2 2600 7768  
cs@flamegold.com.tw

**TANZANIA\***

Eppendorf Middle East and Africa FZ-LLC  
P. O. Box 502019  
Al Thuraya Tower 1 / Office 901  
Media City, Dubai  
UNITED ARAB EMIRATES  
Tel: +971 4 369 29 54  
Fax: +971 4 368 82 60  
info-dubai@eppendorf.ae  
www.eppendorf.ae

**TURKEY**

Incekalar A. S.  
1404. Sok. No: 16,  
N. Akar Mah., Balgat  
06520 Ankara  
TURKEY  
Tel.: +90 312 295 25 25  
Fax: +90 312 295 25 00  
eppendorf@incekara.com.tr  
www.incekara.com.tr

**UNITED ARAB EMIRATES\***

Eppendorf Middle East and Africa FZ-LLC  
P. O. Box 502019  
Al Thuraya Tower 1 / Office 901  
Media City, Dubai  
UNITED ARAB EMIRATES  
Tel: +971 4 369 29 54  
Fax: +971 4 368 82 60  
info-dubai@eppendorf.ae  
www.eppendorf.ae

**UNITED KINGDOM\***

Eppendorf UK Limited  
Eppendorf House  
Gateway 1000 Whittle Way  
Arlington Business Park  
Stevenage SG1 2FP, UNITED KINGDOM  
Tel.: +44 1438 735 888  
Fax: +44 1438 735 889  
sales@eppendorf.co.uk  
www.eppendorf.co.uk

**VIETNAM\*\***

An Duong Science Technological Equipment  
Company Ltd.  
R301, Building 131 Bui Thi Xuan  
Hai Ba Trung Dist.  
Hanoi, Vietnam  
Tel.: +84 4 6278 2595  
Fax.: +84 4 6278 2597  
info@adgroup.vn  
www.adgroup.vn

**ZIMBABWE\***

Eppendorf Middle East and Africa FZ-LLC  
P. O. Box 502019  
Al Thuraya Tower 1 / Office 901  
Media City, Dubai  
UNITED ARAB EMIRATES  
Tel: +971 4 369 29 54  
Fax: +971 4 368 82 60  
info-dubai@eppendorf.ae  
www.eppendorf.ae

**THAILAND\***

Eppendorf (Thailand) Co., Ltd.  
5 Soi Krungthepkreetha 4,  
Huamark, Bangkok,  
Bangkok 10240  
THAILAND  
Tel.: +66 2 379 4212-5  
Fax: +66 2 379 4216  
info@eppendorf.co.th  
www.eppendorf.co.th

**UGANDA\***

Eppendorf Middle East and Africa FZ-LLC  
P. O. Box 502019  
Al Thuraya Tower 1 / Office 901  
Media City, Dubai  
UNITED ARAB EMIRATES  
Tel: +971 4 369 29 54  
Fax: +971 4 368 82 60  
info-dubai@eppendorf.ae  
www.eppendorf.ae

**UNITED ARAB EMIRATES**

Gulf Drug L.L.C.  
Next to Saleh Bin Lahej Building, Al Barsha 1  
P.O.Box 3264  
Dubai  
UNITED ARAB EMIRATES  
Tel.: +971 4 501 4000  
Fax: +971 4 501 4100  
info@gulfdrug.com  
www.gulfdrug.com

**USA\***

Eppendorf North America, Inc.  
102 Motor Parkway  
Hauppauge, NY 11788-5178  
USA  
Tel.: +1 800 645 3050  
+1 516 334 7500  
Fax: +1 516 334 7506  
info@eppendorf.com  
www.eppendorfna.com

**YEMEN\***

Eppendorf Middle East and Africa FZ-LLC  
P. O. Box 502019  
Al Thuraya Tower 1 / Office 901  
Media City, Dubai  
UNITED ARAB EMIRATES  
Tel: +971 4 369 29 54  
Fax: +971 4 368 82 60  
info-dubai@eppendorf.ae  
www.eppendorf.ae

**TUNISIA\***

Eppendorf Middle East and Africa FZ-LLC  
P. O. Box 502019  
Al Thuraya Tower 1 / Office 901  
Media City, Dubai  
UNITED ARAB EMIRATES  
Tel: +971 4 369 29 54  
Fax: +971 4 368 82 60  
info-dubai@eppendorf.ae  
www.eppendorf.ae

**UKRAINE**

Alsi Ltd.  
Shovkunenکو str., 8/20  
of. 51  
03049 Kiev  
UKRAINE  
Tel.: +380 44 245 3224  
info@alsi.kiev.ua or mt@alsi.kiev.ua  
www.alsi.ua

**UNITED ARAB EMIRATES\*\***

Emphor FZCO  
P.O.Box: 61232  
Al Quos Industrial Area 3  
(Behind Al Quos Oasis Centre)  
Warehouse # 5, Dubai,  
UNITED ARAB EMIRATES  
Tel.: +971 43392603  
Fax: +971 4 8830133  
nilesh@emphor.biz

**VIETNAM**

BCE Vietnam  
10th Floor, LICOGI 13 Tower,  
No.164 Khuat Duy Tien Str.  
Thanh Xuan District  
Hanoi, Vietnam  
Tel.: +84 4 3234 5666  
Fax.: +84 4 3234 5668  
info@bcevietnam.com.vn  
www.bcevietnam.com.vn

**ZAMBIA\***

Eppendorf Middle East and Africa FZ-LLC  
P. O. Box 502019  
Al Thuraya Tower 1 / Office 901  
Media City, Dubai  
UNITED ARAB EMIRATES  
Tel: +971 4 369 29 54  
Fax: +971 4 368 82 60  
info-dubai@eppendorf.ae  
www.eppendorf.ae

# Legal Notices, Trademarks, patent and design Attributions

## Eppendorf group patents:

Eppendorf is the owner of numerous patents worldwide. Please respect our intellectual property. The following products and services are protected by patents in the US and in other countries. The purpose of this catalog is to fulfill the provisions for the virtual arrogation of patents of the "America Invents Act". The following list of the products and services supplied by the Eppendorf group may be incomplete, and other products and services supplied by the Eppendorf group which are not listed here may be protected by American patents or patents of other countries. Any information on patents for products and services which are not listed in this catalog will be stated on the products, on the packaging or on the inserts, if in doubt, please check these. In addition to the patents listed below, other patents may have been applied for.

## Disclaimer

epMotion® M5073/M5073c/5075m: This product and its use may be covered by one or more patents owned by Gen-Probe Incorporated. The purchase price for this product includes only limited, nontransferable rights under certain claims of certain patents owned by Gen-Probe Incorporated to use this product for research purposes only. No other rights are conveyed. Purchaser is not granted any rights under patents of Gen-Probe Incorporated to use this product for any commercial use. Further information regarding purchasing a license under patents of Gen-Probe Incorporated to use this product for any other purposes, including, without limitation, for commercial use, may be obtained by contacting Gen-Probe Incorporated, Attn: Business Development Department, 10210 Genetic Center Drive, San Diego, California 92121-4362, U.S.A.

## Trademark Information:

The trademarks of the Eppendorf group are recognized worldwide. Please respect our brands as we will protect their use.

## US Patents Eppendorf Group

Product	Patent number
BioBLU® 5p, BioBLU® 5c, BioBLU® 14c, BioBLU® 50c	US 8,522,996
BioBLU® 1c, BioBLU® 3c, BioBLU® 5c, BioBLU® 5p, BioBLU® 14c, BioBLU® 50c	US 9,347,912
Impeller for BioFlo® 510, BioFlo® 610, BioFlo® PRO	US 8,292,591
Centrifuge 5418 R	US 6,866,621
Centrifuge 5418R, 5424R, 5430R, 5427R	US 8,845,967
Centrifuge 5424 R	US 6,866,621
Centrifuge 5424R, 5427 R	US 8,783,737
Centrifuge 5430 R	US 6,866,621
Centrifuge 5702 swing-bucket rotor	US 6,746,391
Centrifuge 5702 R, 5702 RH	US 6,866,621
Aerosol-tight fixed-angle rotor for Centrifuges 5920R, 5804, 5804R, 5810, 5810R, 5427R, 5430, 5430R, 5418, 5418R	US 9,149,815
Combitips advanced® 25ml / 50ml	US 8,839,685 US 8,813,584 US 9,291,529
Combitips advanced®	US 8,813,584 US 9,291,529
Easypet® 3	US 9,028,774

Electrofusation Buffers	US 7,157,257
Electroporation Buffer	US 7,157,257
ep Dualfilter T.I.P.S.® SealMax	US9,138,741
epMotion® 5073; epMotion® 5075	US 8,377,396
epMotion® 5075 VAC	US 6,666,978
Eppendorf BioSpectrometer® Family	US 8,464,171
Eppendorf Cell Culture Flasks (all)	US 9,708,576
Eppendorf Cell Culture Flasks (all Flasks with plug-seal cap)	US 9,776,771
Eppendorf Deepwell Plate	US 8,636,965
Eppendorf Injectman® 4	US 9,644,763
Eppendorf Microplates	US 8,636,965
Eppendorf PiezoXpert®	US 9,422,520
Eppendorf Reference® 2	US 7,674,432 US 8,297,134 US 9,044,749
Eppendorf Reference® 2 multi channel	US 7,673,532 US 9,339,811 US 9,393,561
Eppendorf Reference® 2 single channel ≤ 1000 µl Eppendorf Reference® 2 multi channel	US 7,434,484 US 9,027,419
Eppendorf Reference® 2 variable	US 9,295,986
Eppendorf Research® plus	US 7,674,432 US 8,133,453 US 8,297,134
Eppendorf Research® plus ≤ 1000 µl	US 7,434,484
Eppendorf Research® plus multi channel	US 7,673,532 US 9,393,561
Eppendorf ThermoMixer® C	US 8,827,540 US 9,016,929 US 9,352,323
Eppendorf ThermoMixer® F0.5, F1.5, F2.0	US 8,827,540 US 9,016,929
Eppendorf ThermoMixer® FP	US 8,827,540 US 9,352,323
Eppendorf ThermoStat™ C	US 9,352,323
Eppendorf TransferMan® 4r	US 9,644,763
Eppendorf TransferMan® 4m	US 9,644,763
Eppendorf Xplorer®/ Eppendorf Xplorer® plus	US 6,499,365 US 6,778,917 US 7,585,468 US 7,674,432 US 7,694,592 US 8,028,592 US 8,096,198 US 8,570,051 US 9,403,163 US 9,579,645
Eppendorf Xplorer®/Eppendorf Xplorer® plus multi channel	US 7,673,532 US 9,393,561
Eppendorf Xplorer®/Eppendorf Xplorer® plus single channel ≤ 1.000 µl	US 7,434,484
Eppendorf Xplorer®/Eppendorf Xplorer® plus multi channel <1.250 µl	US 7,673,532 US 9,393,561
Eppendorf µCuvette®	US 9,677,994
gripping tool for epMotion® 5073; epMotion® 5075	US 7,462,327
Innova S44i	US 8,226,291
MagSep reagent kits	US 8,940,248

Mastercycler® pro Family	US 8,492,137 US 8,722,394
Mastercycler® pro Family; Mastercycler® nexus Family	US 8,322,918 US 8,722,394
MixMate®	US 7,575,363 US 8,550,696
Multipette®/Repeater family	US 8,114,361 US 9,011,799 US 9,579,645
Multipette®/Repeater M4	US 8,408,079 US 9,180,446 US 8,813,584 US 9,291,529 US 9,289,762 US 9,579,644
Multipette®/Repeater® stream/ Xstream, Multipette®/Repeater® E3/ E3x	US 6,499,365 US 6,778,917 US 7,585,468 US 7,731,908 US 8,813,584 US 9,291,529 US 9,289,762
Multiporator®	US 6,008,038
Optical sensor epMotion®; epMotion® 5070, 5057 - alle Typen	US 6,819,437
PCR Cooler	US 6,616,897
Pipetting tool for epMotion®	US 8,377,396
twin.tec PCR Plates	US 6,340,589 US 7,347,977 US 7,767,153 US 8,636,965
Uvette®	US 6,249,345

## US Design Patents Eppendorf Group

	Patent number
epMotion® 96 Interface	US D771661
Eppendorf Centrifuge Rotor	US D760400
Eppendorf Combitips®	US D709623 US D706946 US D733909 US D733910 US D740436 US D740437 US D782619
ep Dualfilter T.I.P.S.®	US D679826
Eppendorf Research® plus	US D625429
Eppendorf ThermoMixer®	US D569988 US D731237 US D759265 US D759266 US D798468 US D798467 US D798466
Eppendorf Plates®	US D601713 US D601714
Eppendorf Xplorer®	US D674913
Eppendorf µCuvette®	US D731671
Multipette® stream and Multipette® Xstream	US D548358

## Trademarks Eppendorf Group















Trademark	Status	Owner
BioBLU	®	Eppendorf AG
BioCommand	®	Eppendorf, Inc.
BioFlo	®	Eppendorf, Inc.
Biomaster	®	Eppendorf AG
Biopur	®	Eppendorf AG
cellferm-pro	®	DASGIP Information and Process Technology GmbH
CelliGen	®	Eppendorf, Inc.
CellTram	®	Eppendorf AG
CellXpert	®	Eppendorf AG
Combilong	®	Eppendorf AG
Combitips	®	Eppendorf AG
Combitips advanced	®	Eppendorf AG
Combitips plus	®	Eppendorf AG
condens.protect	®	Eppendorf AG
ConvexAccess	™	Eppendorf AG
CryoCube	®	Eppendorf AG
DASbox	®	DASGIP Information and Process Technology GmbH
DASGIP	®	DASGIP Information and Process Technology GmbH
DASware	®	DASGIP Information and Process Technology GmbH
DualSpeed	™	Eppendorf AG
Easypet	®	Eppendorf AG
eLAB	™	Bio-ITech BV
eLabJournal	®	Bio-ITech BV
ep Dualfilter T.I.P.S.	®	Eppendorf AG
epBlue	™	Eppendorf AG
epGreen	®	Eppendorf AG
epMotion	®	Eppendorf AG
Eppendorf	®	Eppendorf AG
Eppendorf µCuvette	®	Eppendorf AG
Eppendorf Advantage	™	Eppendorf AG
Eppendorf BioPhotometer	®	Eppendorf AG
Eppendorf BioPhotometer plus	®	Eppendorf AG
Eppendorf BioSpectrometer	®	Eppendorf AG
Eppendorf Combitips	®	Eppendorf AG
Eppendorf EasyCon	™	Eppendorf AG
Eppendorf Eporator	®	Eppendorf AG
Eppendorf Kit rotor	®	Eppendorf AG
Eppendorf LoBind	®	Eppendorf AG
Eppendorf MagSep	™	Eppendorf AG
Eppendorf PerfectPiston	®	Eppendorf AG
Eppendorf PhysioCare Concept	®	Eppendorf AG
Eppendorf PiezoXpert	®	Eppendorf AG
Eppendorf Plates	®	Eppendorf AG
Eppendorf Quality	™	Eppendorf AG
Eppendorf QuickLock	®	Eppendorf AG
Eppendorf QuickRelease	™	Eppendorf AG
Eppendorf Reference	®	Eppendorf AG
Eppendorf Research	®	Eppendorf AG
Eppendorf Research pro	®	Eppendorf AG
Eppendorf SmartBlock	™	Eppendorf AG
Eppendorf SpectraZoom	®	Eppendorf AG
Eppendorf ThermoMixer	®	Eppendorf AG
Eppendorf ThermoMixer 1.5 mL	®	Eppendorf AG
Eppendorf ThermoMixer plates	®	Eppendorf AG

















## Legal Notices, Trademarks, patent and design Attributions

Trademark	Status	Owner
Eppendorf ThermoStat	™	Eppendorf AG
Eppendorf ThermoStat expert	®	Eppendorf AG
Eppendorf ThermoTop	®	Eppendorf AG
Eppendorf Top Buret	™	Eppendorf AG
Eppendorf Tubes	®	Eppendorf AG
Eppendorf twin.tec	®	Eppendorf AG
Eppendorf Varitips	®	Eppendorf AG
Eppendorf Xplorer	®	Eppendorf AG
Eppi	™	Eppendorf AG
epPoints	®	Eppendorf AG
epServices for premium performance	®	Eppendorf AG
epT.I.P.S.	®	Eppendorf AG
Excella	®	Eppendorf, Inc.
FastTemp pro	®	Eppendorf AG
fedbatch-pro	®	DASGIP Information and Process Technology GmbH
FemtoJet	®	Eppendorf AG
Femtotips	®	Eppendorf AG
flexlid	®	Eppendorf AG
Flex-Tube	®	Eppendorf AG
Galaxy	®	Eppendorf, Inc.
GELoader	®	Eppendorf AG
g-Safe	®	Eppendorf AG
HEF	®	Eppendorf, Inc.
In touch with life	®	Eppendorf AG
InjectMan	®	Eppendorf AG
Innova	®	Eppendorf, Inc.
IsoTherm-System	®	Eppendorf AG
Masterclear	®	Eppendorf AG
Mastercycler	®	Eppendorf AG
Mastertip	®	Eppendorf AG
Maxipettor	®	Eppendorf AG
Microloader	™	Eppendorf AG
Mimitate	™	Eppendorf AG
Minispin	®	Eppendorf AG
MixMate	®	Eppendorf AG
Multipette	®	Eppendorf AG
Multipette smart	®	Eppendorf AG
Multiporator	®	Eppendorf AG
Nanotip	®	Eppendorf AG
New Brunswick	™	Eppendorf AG
OptiBowl	®	Eppendorf AG
OptiTrack	®	Eppendorf AG
PhysioCare Concept	®	Eppendorf AG
PourMatic	®	Eppendorf, Inc.
Picaso	®	Eppendorf AG
Pipet Helper	®	Eppendorf AG
RecoverMax	®	Eppendorf AG
Repeater	®	Eppendorf AG
Silence   Speed   Simplicity	®	Eppendorf AG
SplashProtect	™	Eppendorf AG
STAGBIO	®	Eppendorf AG
SteadySlope	®	Eppendorf AG

Trademark	Status	Owner
ThermoMixer	®	Eppendorf AG
TransferMan	®	Eppendorf AG
TransferTip	®	Eppendorf AG
Transjector	®	Eppendorf AG
UVette	®	Eppendorf AG
Vacufuge	®	Eppendorf AG
vapoprotect	®	Eppendorf AG
Varipette	®	Eppendorf AG
Varispenser	®	Eppendorf AG
ViscoTip	™	Eppendorf AG
VisioNize	®	Eppendorf AG







### Figurative marks / 3D marks

Trademark	Status	Owner
	®	Eppendorf AG
	®	Eppendorf AG
	®	Eppendorf AG
	®	Eppendorf AG
	®	Eppendorf AG
	®	Eppendorf AG
	®	Eppendorf AG
	®	Eppendorf AG
	®	Eppendorf AG
	®	Eppendorf AG
	®	Eppendorf AG
	®	Eppendorf AG
	®	Eppendorf AG
	®	Eppendorf AG

Trademark	Status	Owner
	®	Eppendorf AG
	®	Eppendorf AG (USPTO)
	®	Eppendorf AG
	®	Eppendorf AG
	®	Eppendorf AG
	®	Eppendorf AG
	®	Eppendorf AG
	®	Eppendorf AG
	®	Eppendorf AG
	®	Eppendorf AG
	®	Eppendorf AG
	®	Eppendorf AG
	®	Eppendorf AG
	®	Eppendorf AG
	®	Eppendorf AG
	®	Eppendorf AG

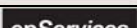
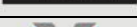
## Legal Notices, Trademarks, patent and design Attributions

### Figurative marks

Trademark	Status	Owner
	®	Eppendorf AG
	®	Eppendorf AG
	®	Eppendorf AG
	®	Eppendorf AG
	®	Eppendorf AG
	TM	Eppendorf AG
	®	Bio-ITech BV
	®	Bio-ITech BV
	®	Calibration Technology LTD.

### Further Trademarks

Trademark	Status	Owner
AddThis	®	Addthis Inc.
Adidas	®	Adidas AG
Adobe	®	Adobe Systems Inc.
Adobe Flash	®	Adobe Systems Inc.
Adobe logo	®	Adobe Systems Inc.
Allen Bradley	™	Rockwell Automation Inc.
Amazon	®	Amazon Europe Holding Tech. SCS
American Express	®	The American Express Company
Android	™	Google Inc.
analytica	®	Messe München GmbH
Apple	®	Apple Inc.
Applikon	®	Applikon B.V.
Axio	®	Carl-Zeiss-Stiftung DBA Carl Zeiss
Axiovert	®	Carl-Zeiss-Stiftung DM Carl Zeiss
Biochrom	®	Harvard Apparatus, Inc
BIODISCOVERY	®	BioDiscovery, Inc.
Bio-Rad	®	Bio-Rad Laboratories
BioSpec	®	Secomam & Societe d'etudes et de construction
Brij	®	Croda Americas LLC
Centriprep	®	Millipore Corporation
Centronics	®	Centronics Data Computer Corporation
CompactLogix	™	Rockwell Automation Inc.
Cryotube	®	Vanguard International, Inc
Cryovial	®	Simport Plastiques Corporation
Diaphot	®	Nikon Inc
Duran	®	Schott AG
ErgoOne	®	Starlab International GmbH
ErgoOne logo	®	Starlab International GmbH
Excel	®	Microsoft Corporation
Facebook	®	Facebook Inc.
Falcon	®	Becton, Dickinson and Company
Fibra-Cel	®	Imerys Minerals California, Inc.
Ficoll	®	Pharmacia Fine Chemicals, Inc.
Fortron	®	Fortron Industries Corporation
FTA	®	Flinders Technologies Pty Ud.
FugeOne	®	Starlab International GmbH
Fujifilm	®	Fuji Photo Film Co., Ltd.
GAMP	®	International Society For Pharmaceutical Engineering Inc.
GE Healthcare	®	General Electric Company
Genequant	®	Harvard Apparatus, Inc
GEO	®	Gruner + Jahr AG & Co KG
GEO schützt den Regenwald e.V. logo	®	Gruner + Jahr AG & Co KG
GEO.DE	®	Gruner + Jahr AG & Co KG

### Trademark Status Owner

Trademark	Status	Owner
Google Apps	™	Google Inc.
Google Maps	™	Google Inc.
Google Store	™	Google Inc.
HAMA	®	HAMA GmbH & Co. KG.
HARIBO	®	HARIBO GmbH
Hellma	®	Hellma GmbH
Hitachi	®	Hitachi, Ud
ilmac	®	MCH Group AG
ImaGene	®	BioDiscovery, Inc.
in-cosmetics	®	Reed Exhibitions Ltd.
Interphex	®	Reed Elsevier Properties Inc.
iOS	®	Apple Inc.
iPad	®	Apple Inc.
iPhone	®	Apple Inc.
iPod	®	Apple Inc.
iPod touch	®	Apple Inc.
ISM	®	Mettler-Toledo AG
iTunes	®	Apple Inc.
LabMed	®	Medirex a.s.
Laborama	®	UDIAS A.S.B.L
Leatherman	®	Leatherman Tool Group Inc.
Leica	®	Leica Technology
Leica logo	®	Leica Technology
LightCycler	®	Roche Diagnostics GmbH
Maglite	®	MAG Instrument, Inc.
MasterCard	®	MasterCard International tncorporated
Mathlab	®	Mathworks Inc.
MegaBACE	®	Amersham Pharmacia Biotech
Mettler Toledo	®	Mettler-Toledo AG
MICROONE	®	Starlab International GmbH
Microsoft	®	Microsoft Corporation
Microtainer	®	Becton , Dickinson And Company
Moleskine	®	Moleskine S.R.L.
MVS	®	MaeLean-Fogg Company
Nalgene	®	Nalge Nunc International Corp.
Nikon	®	Nikon Inc.
Nikon logo	®	Nikon Inc.
NIST	®	National Institute of Standards and Technology U.S.Department of Commerce
Nunc	®	Nunc NS Corporation
Ohaus	®	Ohaus Cooperation
Olympus	®	Olympus Optical Co., Ltd
Olympus logo	®	Olympus Optical Co., Ltd
Oregon Scientific	®	Oregon Scientific Inc.
Ortlieb	®	Ortlieb

### Trademark Status Owner

Trademark	Status	Owner
Pentium	®	Intel Corporation
PerkinElmer	®	PerkinElmer, Inc.
Philips	®	Philips GmbH
PicoGreen	®	Molecular Probes, Inc.
Plexiglas	®	Arkema Inc.
QIAGEN	®	QIAGEN GmbH
Red dot design award logo	®	red dot GmbH & Co. KG
Reisenthal	®	Reisenthal
RepeatOne	®	Starlab International GmbH
SanDisk	®	SanDisk Corp.
Sartorius	®	Sartorius AG
SENSEO	®	Koninklijke Douwe Egberts B.V.
Shimadzu	®	Shimadzu Corporation
SIGG	®	SIGG Switzerland AG
SmartCycler	®	Cepheid Corporation
Speedminton	®	Speedminton GmbH
SQL Server	®	Microsoft Corporation
STAR LAB logo	®	Starlab International GmbH
Techne	®	Techne Corporation
Thermo Fisher Scientific	®	Thermo Fisher Scientific, Inc.
TIPONE	®	USA Scientific Inc.
TIPONE L	®	USA Scientific Inc.
Triton	®	Union Carbide Chemicals & Plastics Inc.
TUBEONE	®	Starlab International GmbH
TÜV Nord logo	®	TÜV Nord GmbH
Tween	®	ICI Americas, Inc.
Twitter	®	Twitter Inc.
UVEX	®	UVEX Med. LLC Lim.
Vacutainer	®	Becton, Dickinson and Company
VISA	®	Visa International Service Association
Windows	®	Microsoft Corporation
YouTube	™	Google Inc.
Zeiss	®	Carl-Zeiss-Stiftung DM Carl Zeiss
Zeiss logo	®	Carl-Zeiss-Stiftung DM Carl Zeiss

## Application and Technical support



**Your local distributor:**  
[www.eppendorf.com/contact](http://www.eppendorf.com/contact)



**North America:**  
+1 800 645 3050, menu option 2  
[techserv@eppendorf.com](mailto:techserv@eppendorf.com)

**Asia Pacific:**  
+603 8023 6869  
[support\\_asiapacific@eppendorf.com](mailto:support_asiapacific@eppendorf.com)

Eppendorf Bioprocessing-Catalog. More info at [www.eppendorf.com/catalog](http://www.eppendorf.com/catalog)

