

Timesco is internationally recognised as one of the leading producers and suppliers of theatre quality (OR) surgical instruments and medical products. We produce products covering a vast spectrum of surgical and medical applications. Please contact your local Timesco Territory Manager or your local Timesco distributor for details on our full range, or visit our website at www.timesco.com

INSTRUMENTS FOR LIFE™

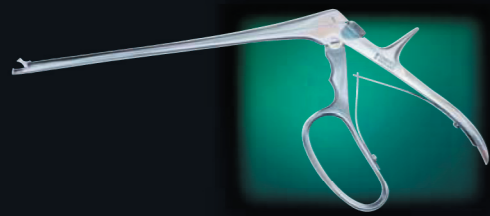

SURGICAL

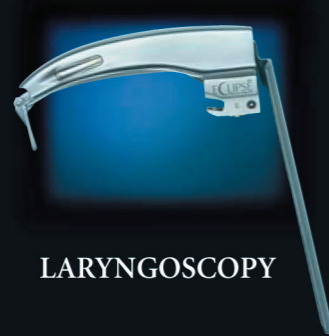

LARYNGOSCOPY



EMERGENCY



FOOTCARE

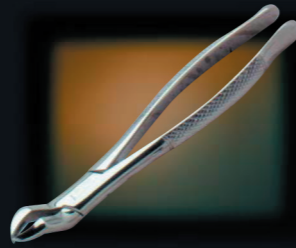

DENTAL



DIAGNOSTIC

DEALER INFO:



Timesco of London, Timesco House, 3 Carnival Park, Carnival Close, Basildon Essex SS14 3WN England.

T: 01268 297 700 F 01268 297 800 E: info@timesco.com
www.timesco.com

E & O.E. Copyright September 2005. Ref C.S.010/1

"Timesco" and "Instruments for Life" are registered trademarks of Timesco of London. All rights reserved.

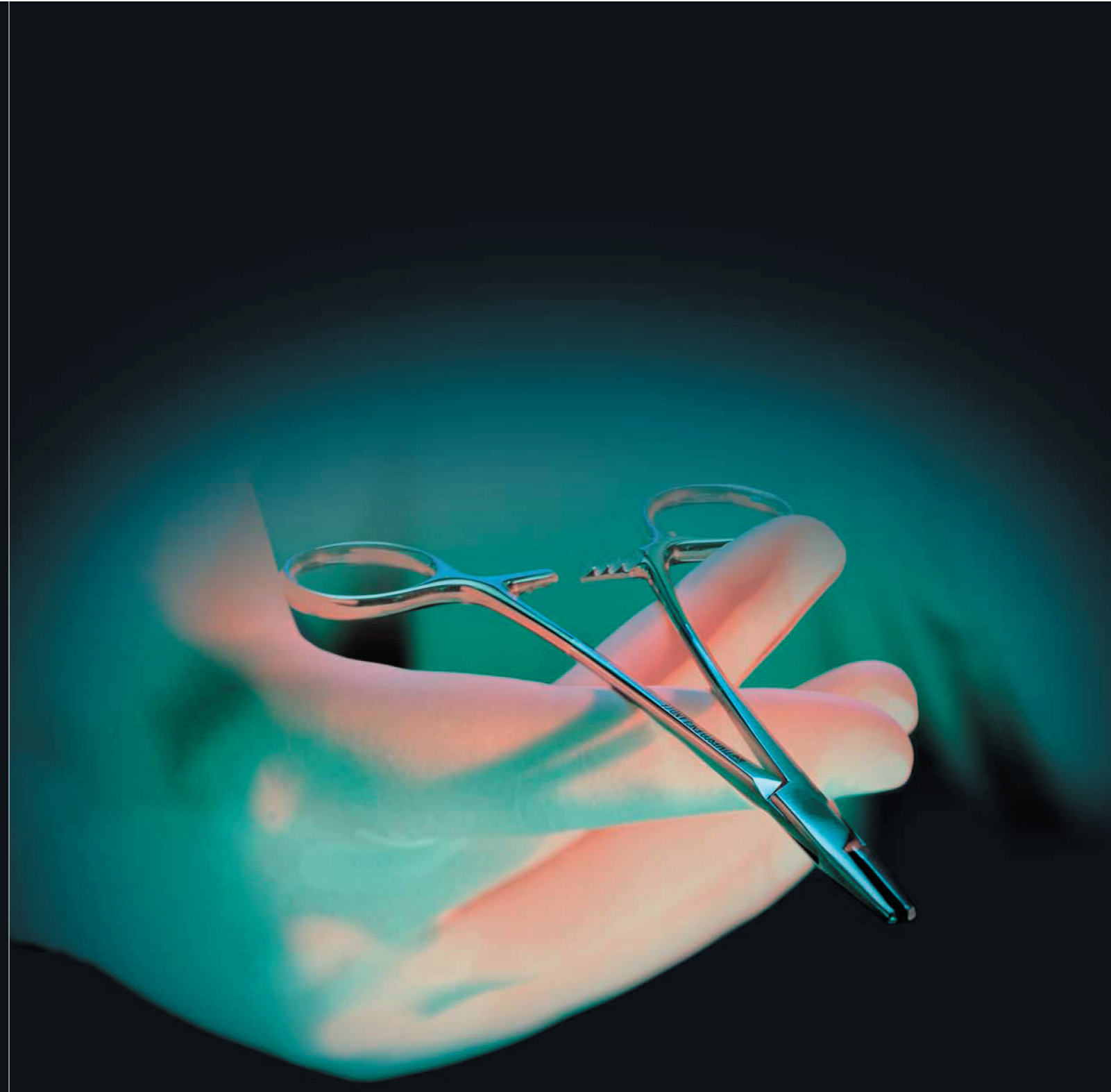

ESSENTIAL GENERAL SURGERY INSTRUMENTS



TIMESCO ESSENTIAL GENERAL SURGERY INSTRUMENTS

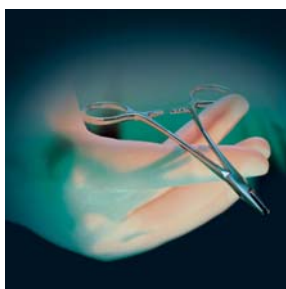

This catalogue has been produced to show some of the most popular General Surgical Instruments available from our complete product range.

Most surgical procedures will require a selection of general instruments and additional instrumentation specifically for the procedure involved, i.e. Gynaecology, Orthopaedics, E.N.T., Plastic Surgery etc. This catalogue illustrates the wide range of products which will commonly be used in most surgical procedures.

We have listed a large selection of dissecting forceps, artery forceps, needle holders, retractors, scissors and other essential items for general procedures.

Whilst the content of this catalogue has been carefully prepared with input from leading hospitals and consultants throughout the U.K. and Ireland, the range is by no means exhaustive or a full listing of our complete range. We produce over 6,000 surgical instruments covering all areas of surgery. We have a large range of catalogues for specialist areas of surgery which are available on request or via our website www.timesco.com.

The common thread through our product range is quality. All our surgical instruments are made of the highest grade stainless steels to exacting tolerances and specifications to produce some of the finest instruments available in the world. With over 40 years of manufacturing expertise, we believe our instruments provide excellent clinical performance and will provide years of trouble free service.

Our instruments are fully autoclaveable and covered by our unrivalled Lifetime Guarantee. If a product fails during its working life, due to a manufacturing or material defect, we will repair it or replace it - free of charge, with the minimum of fuss and delay. Can your current instrument provider deliver the same promise and back it up?

We hope this catalogue will give you a flavour of the exceptional range of quality surgical instruments we produce. If you have experienced the benefit of Timesco instruments, you will no doubt be familiar with the high level of service we provide to compliment the quality of our products. If you have not, simply contact your local Timesco Territory Manager or your local Timesco distributor for samples and further information, we promise you will not be disappointed.

TIMESCO – INSTRUMENTS FOR LIFE™

LIFETIME GUARANTEE

At Timesco, since 1964, we have maintained a simple philosophy, “look after our customers.” This is why all Timesco Reusable Surgical Instruments are covered by our unrivalled Lifetime Guarantee.

Should any of our reusable instruments crack, break, bend, deform, corrode or fail whilst being used for the intended purpose, we will simply replace it with a new one or repair it free of charge. This guarantee applies throughout the working life of the instrument.

We do not require purchase order numbers, copy invoices or other proofs of purchase, the Timesco brand on the product acts as your guarantee. All we ask is that the instrument is cared for and not abused. Our guarantee does not cover fair wear and tear. Please refer to the care and maintenance in our reprocessing instructions supplied with each instrument.

Should any of our products require attention at any time, we have a dedicated after sales team committed to resolving your problems, quickly and efficiently. Simply call us on (020) 7511 9980 or e-mail us at aftersales@timesco.com for our immediate attention. Customers based outside the UK should contact their local Timesco distributor.



QUALITY STANDARDS

All our reusable theatre instruments conform to the medical services directive 93/42/EEC.

Our instruments are manufactured to conform to the following standards (where applicable):

- BS 5194-2
- BS 5194-3
- BS 5194-4
- BSEN ISO 13402

Quality of Steel

Our instruments are manufactured from steel conforming to BSEN ISO 7153-1 or BS 5194-1 (where applicable). We are certified to ISO 13485 and all of our instruments are CE marked.

SCALPEL HANDLES

STAINLESS STEEL _____ 4

SCISSORS

DRESSING _____ 5
 McINDOE _____ 5
 KILNER _____ 5
 MAYO _____ 6
 IRIS _____ 6
 METZENBAUM _____ 6

SCISSORS

TUNGSTEN CARBIDE

DRESSING _____ 7
 IRIS _____ 7
 KILNER _____ 7
 MAYO _____ 8
 McINDOE _____ 8
 METZENBAUM _____ 8
 STRABISMUS _____ 8

DISSECTING FORCEPS

ADSON _____ 9
 BONNEY _____ 9
 LANE _____ 9
 IRIS _____ 9
 GILLIES _____ 10
 MAINGOT _____ 10
 OFFICER _____ 10
 WAUGH _____ 10
 DEBAKEY _____ 10

ARTERY FORCEPS

BIRKETT _____ 11
 CAIRN _____ 11
 CRILE _____ 11
 CUSHING _____ 11
 DENIS BROWN _____ 12
 DIEFFENBACH _____ 12
 DUNHILL _____ 12
 KELLY _____ 12
 KELLY FRASER _____ 12
 KILNER _____ 13
 LLOYD DAVIS _____ 13
 MAYO OSCHNER _____ 13
 MOYNIHAN _____ 13
 HALSTEAD _____ 14
 ROBERTS _____ 14
 ROCHESTER PEAN _____ 14
 SAWTELL _____ 14

RETRACTORS

LANDON VAGINAL _____ 15
 ST. MARKS (LLOYD DAVIS) _____ 15
 MOYNIHAN _____ 15
 VOLKMANN _____ 16
 DOYEN _____ 16
 DEAVER _____ 16
 KELLY _____ 17
 KILNER _____ 17
 MORRIS _____ 17
 CZERNY _____ 17
 WEISLANDER _____ 18
 TRAVERS _____ 18
 MOLLISON _____ 18
 NORFOLK & NORWICH _____ 18
 BALFOUR _____ 19
 GOLIGHER _____ 19
 GOSSET _____ 20
 JOLL THYROID _____ 20

SKIN RETRACTORS

ALMS SKIN _____ 21
 CUSHING VEIN & NERVE _____ 21

SKIN HOOKS

GILLIES _____ 21
 McINDOE _____ 21

INSTRUMENT PINS

MAYO _____ 21

TOWEL CLIPS

MOYNIHAN FORCEPS _____ 22
 CROSS ACTION _____ 22
 BACHAUSE _____ 22

SPONGE HOLDERS

RAMPLEY _____ 22

TISSUE FORCEPS

LITTLEWOOD _____ 23
 BABCOCK _____ 23
 DUVAL _____ 23
 JUDD ALLIS _____ 23
 ALLIS _____ 23
 ALLIS AMERICAN _____ 24
 LANE _____ 24

CHOLECYSTECTOMY

FORCEPS
 MOYNIHAN _____ 24
 LAHEY _____ 24

DISSECTORS

MACDONALD _____ 24
 WATSON CHEYNE _____ 24

NEEDLE HOLDERS

CRILE MURRAY _____ 25
 CRILE WOOD _____ 25
 DERF _____ 25
 DUNHILL _____ 25
 HALSEY _____ 25
 KILNER _____ 25
 MAYO HEGAR _____ 26
 OLSEN HEGAR _____ 26

NEEDLE HOLDERS

TUNGSTEN CARBIDE

DERF _____ 26
 CRILE WOOD _____ 26
 DEBAKEY _____ 27
 FINOCHIETTO _____ 27
 KILNER _____ 27
 HEANEY _____ 27
 CASTROVIEJO _____ 28
 MAYO HEGAR _____ 28
 GILLIES _____ 28
 HALSEY _____ 28

TROCARS & SUCTION TUBES

TILLEY LICHTWITZ _____ 29
 YANKAUER _____ 29
 FRAZIER _____ 29
 ZOELLNER _____ 29

STAINLESS STEEL HOLLOWWARE

KIDNEY DISHES _____ 30
 LOTION BOWLS _____ 30

11.550.10 No. 3 STAINLESS STEEL 4.75" (12CM)



11.550.15 No. 3 STAINLESS STEEL MARKED IN CM 4.75" (12CM)



11.550.30 No. 4 STAINLESS STEEL 5.25" (13.5CM)



11.550.70 No. 7 STAINLESS STEEL 6.25" (16CM)



11.550.90 No. 9 STAINLESS STEEL 4.5" (11.5CM)



No 3, 7 and 9 handles are suitable for use with the following blades sizes, 6, 9, 10, 10a, 11, 12, 14, 15, 15a, 16, SG3.

No 4 handles are suitable for use with the following blades sizes, 18, 19, 20, 21, 22, 23, 24, 25, 26, 27, 36.



Each instrument is permanently marked with our Timesco logo as our guarantee of quality.

- 12.005.30 DRESSING (STITCH) SCISSORS STRAIGHT 5" (13CM) SHARP/SHARP
- 12.005.40 DRESSING SCISSORS STRAIGHT 5.5" (14CM) SHARP/SHARP
- 12.005.50 DRESSING SCISSORS STRAIGHT 6" (15.5CM) SHARP/SHARP
- 12.005.60 DRESSING SCISSORS STRAIGHT 7" (18CM) SHARP/SHARP
- 12.015.30 DRESSING SCISSORS CURVED 5" (13CM) SHARP/SHARP
- 12.015.40 DRESSING SCISSORS CURVED 5.5" (14CM) SHARP/SHARP
- 12.015.50 DRESSING SCISSORS CURVED 6" (15.5CM) SHARP/SHARP
- 12.015.60 DRESSING SCISSORS CURVED 7" (18CM) SHARP/SHARP

- 12.025.50 DRESSING SCISSORS BLUNT/SHARP 6" (15.5CM)

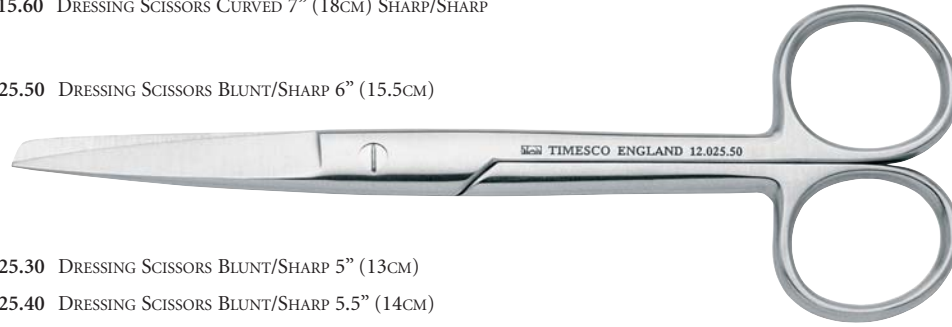

- 12.025.30 DRESSING SCISSORS BLUNT/SHARP 5" (13CM)
- 12.025.40 DRESSING SCISSORS BLUNT/SHARP 5.5" (14CM)
- 12.025.55 DRESSING SCISSORS BLUNT/SHARP 6.5" (16.5CM)
- 12.025.60 DRESSING SCISSORS BLUNT/SHARP 7" (18CM)

- 12.045.60 DRESSING SCISSORS STRAIGHT 7" (18CM) BLUNT/BLUNT

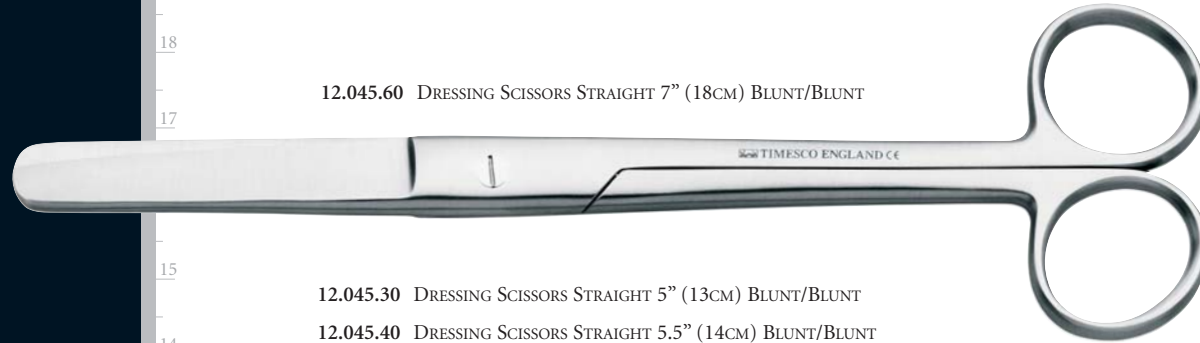

- 12.045.30 DRESSING SCISSORS STRAIGHT 5" (13CM) BLUNT/BLUNT
- 12.045.40 DRESSING SCISSORS STRAIGHT 5.5" (14CM) BLUNT/BLUNT
- 12.045.50 DRESSING SCISSORS STRAIGHT 6" (15.5CM) BLUNT/BLUNT
- 12.055.30 DRESSING SCISSORS CURVED 5" (13CM) BLUNT/BLUNT
- 12.055.40 DRESSING SCISSORS CURVED 5.5" (14CM) BLUNT/BLUNT
- 12.055.50 DRESSING SCISSORS CURVED 6" (15.5CM) BLUNT/BLUNT
- 12.055.60 DRESSING SCISSORS CURVED 7" (18CM) BLUNT/BLUNT

- 12.100.30 DRESSING SCISSORS STRAIGHT 5" (13CM) ONE PROBE POINT
- 12.102.30 DRESSING SCISSORS STRAIGHT 5" (13CM) TWO PROBE POINT

- 12.510.10 MCINDOE SCISSORS STRAIGHT 7.5" (19CM) BLUNT/BLUNT

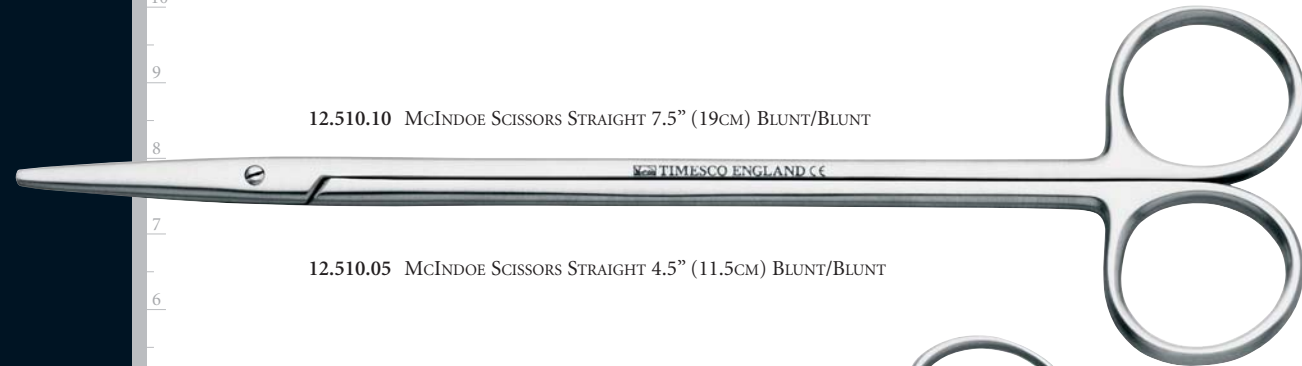

- 12.510.05 MCINDOE SCISSORS STRAIGHT 4.5" (11.5CM) BLUNT/BLUNT

- 12.455.50 KILNER SCISSORS CURVED 4.5" (11.5CM) BLUNT/BLUNT



- 12.502.05 MAYO SCISSORS ROUND STRAIGHT 5.5" (14CM) BLUNT/BLUNT
- 12.502.10 MAYO SCISSORS ROUND STRAIGHT 6.5" (16.5CM) BLUNT/BLUNT
- 12.502.30 MAYO SCISSORS ROUND CURVED 5.5" (14CM) BLUNT/BLUNT
- 12.502.35 MAYO SCISSORS ROUND CURVED 6.5" (16.5CM) BLUNT/BLUNT
- 12.505.05 MAYO SCISSORS FLAT STRAIGHT 5.5" (14CM) BLUNT/BLUNT
- 12.505.10 MAYO SCISSORS FLAT STRAIGHT 6.5" (16.5CM) BLUNT/BLUNT
- 12.505.30 MAYO SCISSORS FLAT CURVED 5.5" (14CM) BLUNT/BLUNT
- 12.505.35 MAYO SCISSORS FLAT CURVED 6.5" (16.5CM) BLUNT/BLUNT

- 12.500.10 MAYO SCISSORS DISHED STRAIGHT 6.5" (16.5CM) BLUNT/BLUNT



- 12.500.05 MAYO SCISSORS DISHED STRAIGHT 5.5" (14CM) BLUNT/BLUNT
- 12.500.15 MAYO SCISSORS DISHED STRAIGHT 7.5" (19CM) BLUNT/BLUNT
- 12.500.20 MAYO SCISSORS DISHED STRAIGHT 8.5" (21.5CM) BLUNT/BLUNT
- 12.500.25 MAYO SCISSORS DISHED STRAIGHT 9.5" (24CM) BLUNT/BLUNT
- 12.500.40 MAYO SCISSORS DISHED CURVED 5.5" (14CM) BLUNT/BLUNT
- 12.500.45 MAYO SCISSORS DISHED CURVED 6.5" (16.5CM) BLUNT/BLUNT

- 12.420.10 IRIS SCISSORS STRAIGHT 4" (10CM) SHARP/SHARP

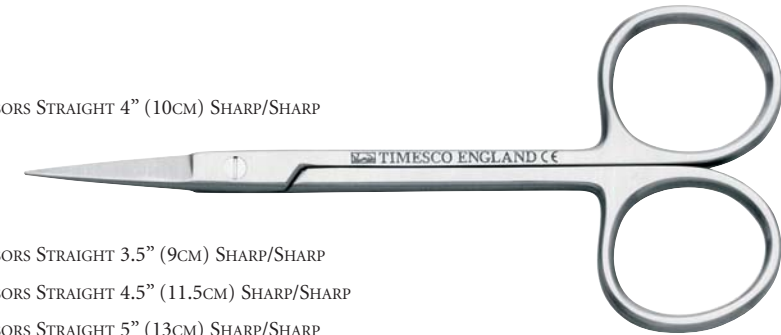

- 12.420.05 IRIS SCISSORS STRAIGHT 3.5" (9CM) SHARP/SHARP
- 12.420.15 IRIS SCISSORS STRAIGHT 4.5" (11.5CM) SHARP/SHARP
- 12.420.20 IRIS SCISSORS STRAIGHT 5" (13CM) SHARP/SHARP
- 12.420.40 IRIS SCISSORS CURVED 5" (13CM) SHARP/SHARP

- 12.540.10 METZENBAUM SCISSORS STRAIGHT 6.5" (16.5CM) BLUNT/BLUNT

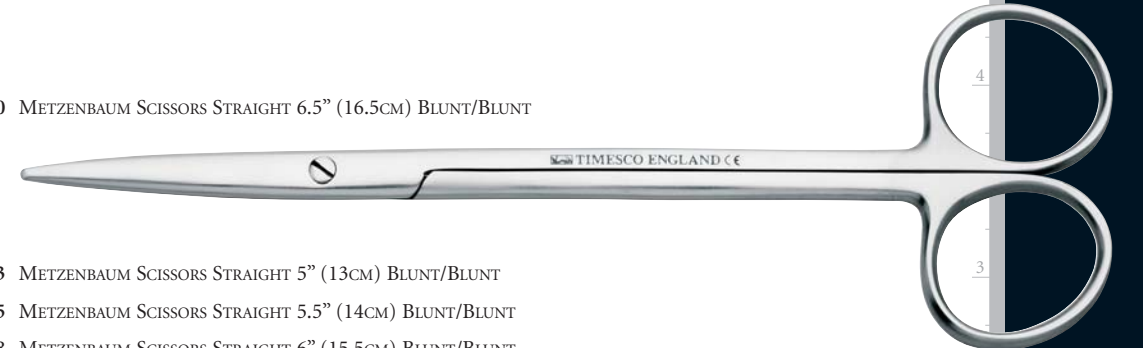

- 12.540.03 METZENBAUM SCISSORS STRAIGHT 5" (13CM) BLUNT/BLUNT
- 12.540.05 METZENBAUM SCISSORS STRAIGHT 5.5" (14CM) BLUNT/BLUNT
- 12.540.08 METZENBAUM SCISSORS STRAIGHT 6" (15.5CM) BLUNT/BLUNT
- 12.540.12 METZENBAUM SCISSORS STRAIGHT 7" (18CM) BLUNT/BLUNT
- 12.540.15 METZENBAUM SCISSORS STRAIGHT 7.5" (19CM) BLUNT/BLUNT
- 12.540.20 METZENBAUM SCISSORS STRAIGHT 8.5" (21.5CM) BLUNT/BLUNT
- 12.540.25 METZENBAUM SCISSORS STRAIGHT 9.5" (24CM) BLUNT/BLUNT
- 12.540.28 METZENBAUM SCISSORS STRAIGHT 10" (25.5CM) BLUNT/BLUNT
- 12.540.30 METZENBAUM SCISSORS STRAIGHT 10.5" (27CM) BLUNT/BLUNT
- 12.540.50 METZENBAUM SCISSORS CURVED 5.5" (14CM) BLUNT/BLUNT
- 12.540.55 METZENBAUM SCISSORS CURVED 6.5" (16.5CM) BLUNT/BLUNT

SCISSORS TUNGSTEN CARBIDE

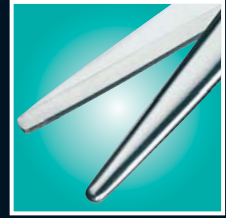

Our Tungsten Carbide scissors have a quality tungsten insert which provides an excellent cutting edge and durability.

- 12.900.20 DRESSING SCISSORS STRAIGHT 5.5" (14CM) SHARP/SHARP TUNGSTEN CARBIDE
- 12.900.30 DRESSING SCISSORS STRAIGHT 6.25" (16CM) SHARP/SHARP TUNGSTEN CARBIDE
- 12.900.60 DRESSING SCISSORS CURVED 5.5" (14CM) SHARP/SHARP TUNGSTEN CARBIDE
- 12.900.70 DRESSING SCISSORS CURVED 6.25" (16CM) SHARP/SHARP TUNGSTEN CARBIDE

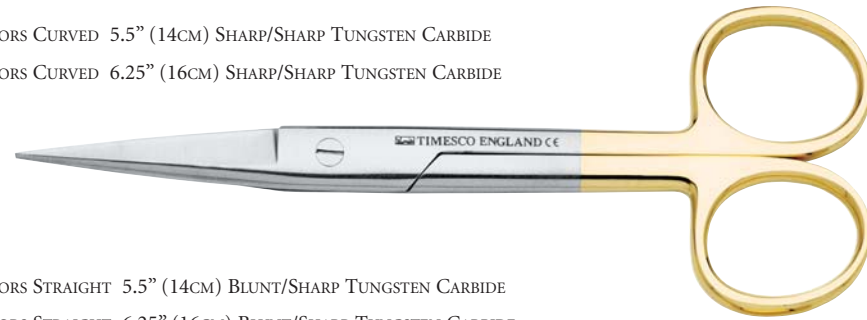

- 12.905.20 DRESSING SCISSORS STRAIGHT 5.5" (14CM) BLUNT/SHARP TUNGSTEN CARBIDE
- 12.905.30 DRESSING SCISSORS STRAIGHT 6.25" (16CM) BLUNT/SHARP TUNGSTEN CARBIDE
- 12.905.60 DRESSING SCISSORS CURVED 5.5" (14CM) BLUNT/SHARP TUNGSTEN CARBIDE
- 12.905.70 DRESSING SCISSORS CURVED 6.25" (16CM) BLUNT/SHARP TUNGSTEN CARBIDE
- 12.910.20 DRESSING SCISSORS STRAIGHT 5.5" (14CM) BLUNT/BLUNT TUNGSTEN CARBIDE
- 12.910.30 DRESSING SCISSORS STRAIGHT 6.25" (16CM) BLUNT/BLUNT TUNGSTEN CARBIDE
- 12.910.60 DRESSING SCISSORS CURVED 5.5" (14CM) BLUNT/BLUNT TUNGSTEN CARBIDE
- 12.910.70 DRESSING SCISSORS CURVED 6.25" (16CM) BLUNT/BLUNT TUNGSTEN CARBIDE

- 12.940.10 IRIS SCISSORS STRAIGHT 4.5" (11.5CM) SHARP/SHARP TUNGSTEN CARBIDE
- 12.940.20 IRIS SCISSORS CURVED 4.5" (11.5CM) SHARP/SHARP TUNGSTEN CARBIDE
- 12.940.30 IRIS SCISSORS ANGLED 4.5" (11.5CM) SHARP/ SHARP TUNGSTEN CARBIDE



- 12.950.10 KILNER SCISSORS STRAIGHT 4.5" (11.5CM) SHARP/SHARP TUNGSTEN CARBIDE

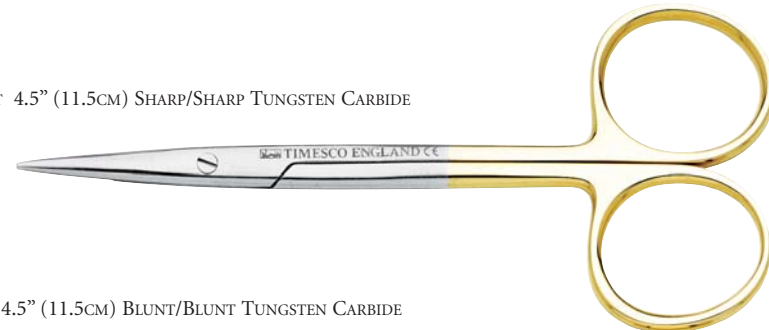

- 12.950.20 KILNER SCISSORS CURVED 4.5" (11.5CM) BLUNT/BLUNT TUNGSTEN CARBIDE

SCISSORS TUNGSTEN CARBIDE



The highest quality gold coating is applied to the handles of each instrument for easy recognition as a tungsten carbide tipped instrument.

- 12.960.15 MAYO SCISSORS FLAT STRAIGHT 6.75" (17CM) BLUNT/BLUNT TUNGSTEN CARBIDE



- 12.960.10 MAYO SCISSORS FLAT STRAIGHT 5.5" (14CM) BLUNT/BLUNT TUNGSTEN CARBIDE
- 12.960.17 MAYO SCISSORS FLAT STRAIGHT 8" (20CM) BLUNT/BLUNT TUNGSTEN CARBIDE
- 12.960.19 MAYO SCISSORS FLAT STRAIGHT 9" (23CM) BLUNT/BLUNT TUNGSTEN CARBIDE
- 12.960.20 MAYO SCISSORS FLAT CURVED 5.5" (14CM) BLUNT/BLUNT TUNGSTEN CARBIDE
- 12.960.30 MAYO SCISSORS FLAT CURVED 6.75" (17CM) BLUNT/BLUNT TUNGSTEN CARBIDE
- 12.960.40 MAYO SCISSORS FLAT CURVED 8" (20CM) BLUNT/BLUNT TUNGSTEN CARBIDE
- 12.960.50 MAYO SCISSORS FLAT CURVED 9" (23CM) BLUNT/BLUNT TUNGSTEN CARBIDE

- 12.965.20 MCINDOE SCISSORS CURVED 7" (18CM) BLUNT/BLUNT TUNGSTEN CARBIDE

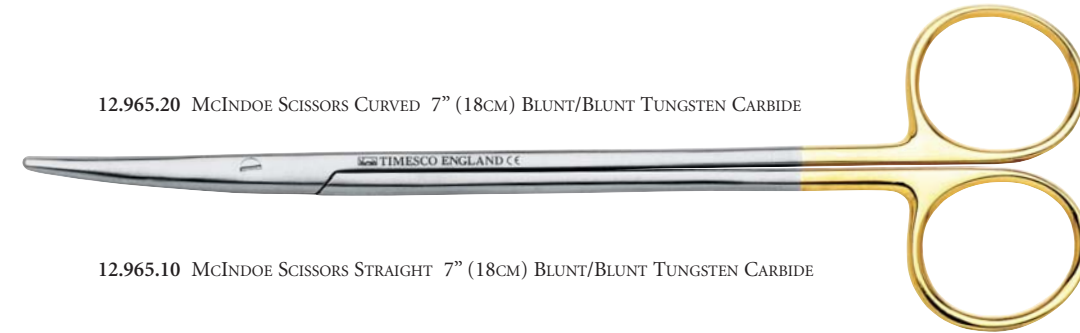

- 12.965.10 MCINDOE SCISSORS STRAIGHT 7" (18CM) BLUNT/BLUNT TUNGSTEN CARBIDE

- 12.970.10 METZENBAUM SCISSORS STRAIGHT 5.5" (14CM) BLUNT/BLUNT TUNGSTEN CARBIDE

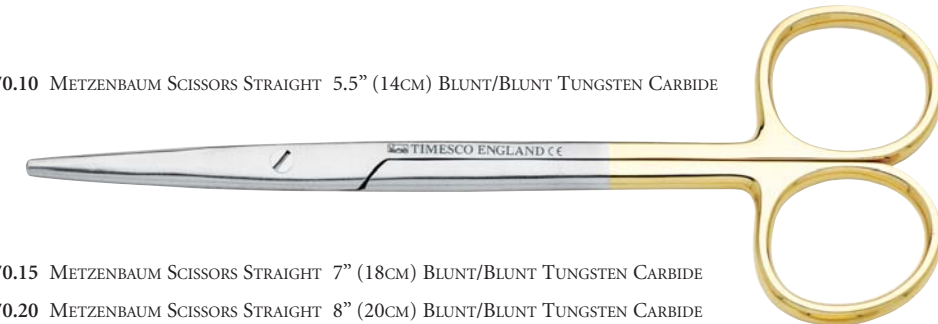

- 12.970.15 METZENBAUM SCISSORS STRAIGHT 7" (18CM) BLUNT/BLUNT TUNGSTEN CARBIDE
- 12.970.20 METZENBAUM SCISSORS STRAIGHT 8" (20CM) BLUNT/BLUNT TUNGSTEN CARBIDE
- 12.970.25 METZENBAUM SCISSORS CURVED 5.5" (14CM) BLUNT/BLUNT TUNGSTEN CARBIDE
- 12.970.30 METZENBAUM SCISSORS CURVED 7" (18CM) BLUNT/BLUNT TUNGSTEN CARBIDE
- 12.970.35 METZENBAUM SCISSORS CURVED 8" (20CM) BLUNT/BLUNT TUNGSTEN CARBIDE

- 12.985.10 STRABISMUS SCISSORS STRAIGHT 4.5" (11.5CM) BLUNT/BLUNT TUNGSTEN CARBIDE

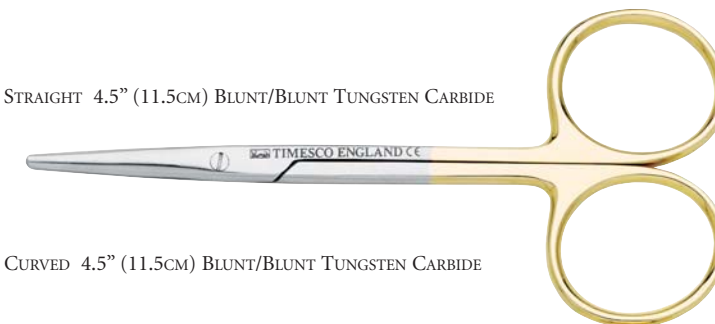

- 12.985.20 STRABISMUS SCISSORS CURVED 4.5" (11.5CM) BLUNT/BLUNT TUNGSTEN CARBIDE

13.080.05 ADSON DISSECTING FORCEPS 4.75" (12CM) SERRATED



13.080.30 ADSON DISSECTING FORCEPS 7" (18CM) SERRATED

13.080.10 ADSON DISSECTING FORCEPS 4.75" (12CM) 1 X 2 TEETH



13.080.35 ADSON DISSECTING FORCEPS 7" (18CM) 1 X 2 TEETH

13.130.10 BONNEY DISSECTING FORCEPS 7" (18CM) SERRATED



13.130.20 BONNEY DISSECTING FORCEPS 7" (18CM) 1 X 2 TEETH SERRATED

13.270.20 LANE DISSECTING FORCEPS 5.75" (14.5CM) 2 X 3 TEETH SERRATED



13.270.05 LANE DISSECTING FORCEPS 5.75" (14.5CM) TEETH SERRATED

13.270.10 LANE DISSECTING FORCEPS 5.75" (14.5CM) 1 X 2 TEETH SERRATED

13.270.30 LANE DISSECTING FORCEPS 5.75" (14.5CM) 3 X 4 TEETH SERRATED

13.270.40 LANE DISSECTING FORCEPS 7" (18CM) 1 X 2 TEETH SERRATED

13.270.50 LANE DISSECTING FORCEPS 7" (18CM) 2 X 3 TEETH SERRATED

13.270.60 LANE DISSECTING FORCEPS 7" (18CM) 3 X 4 TEETH SERRATED

13.270.80 LANE DISSECTING FORCEPS 8" (20CM) 1 X 2 TEETH SERRATED

13.270.90 LANE DISSECTING FORCEPS 8" (20CM) 2 X 3 TEETH SERRATED

13.240.10 IRIS DISSECTING FORCEPS STRAIGHT 4.5" (11.5CM) SERRATED



13.240.05 IRIS DISSECTING FORCEPS STRAIGHT 4" (10CM) SERRATED

13.225.10 GILLIES DISSECTING FORCEPS 6" (15.5CM) 1 X 12 TEETH SERRATED



13.285.20 MAINGOT DISSECTING FORCEPS 11" (28CM) 1 X 2 TEETH



13.285.10 MAINGOT DISSECTING FORCEPS 11" (28CM) SERRATED

13.325.20 OFFICER RECTAL DISSECTING FORCEPS 8" (20CM) 4 X 5 TEETH SERRATED



13.325.10 OFFICER RECTAL DISSECTING FORCEPS 6" (15.5CM) 4 X 5 TEETH SERRATED

13.325.30 OFFICER RECTAL DISSECTING FORCEPS 10" (25.5CM) 4 X 5 TEETH SERRATED

13.425.10 WAUGH DISSECTING FORCEPS 6" (15.5CM) SERRATED



13.425.20 WAUGH DISSECTING FORCEPS 7" (18CM) SERRATED

13.425.30 WAUGH DISSECTING FORCEPS 8" (20CM) SERRATED

13.425.40 WAUGH DISSECTING FORCEPS 6" (15.5CM) 1 X 2 TEETH SERRATED

13.425.50 WAUGH DISSECTING FORCEPS 7" (18CM) 1 X 2 TEETH SERRATED

13.425.60 WAUGH DISSECTING FORCEPS 8" (20CM) 1 X 2 TEETH SERRATED

13.625.10 DEBAKEY DISSECTING FORCEPS STRAIGHT 9.5" (24CM) 1.5MM TIP



13.625.20 DEBAKEY DISSECTING FORCEPS STRAIGHT 9.5" (24CM) 2MM TIP

13.625.30 DEBAKEY DISSECTING FORCEPS STRAIGHT 9.5" (24CM) 2.4MM TIP

13.625.40 DEBAKEY DISSECTING FORCEPS STRAIGHT 9.5" (24CM) 2.7MM TIP

13.625.50 DEBAKEY DISSECTING FORCEPS STRAIGHT 9.5" (24CM) 3.5MM TIP

ARTERY FORCEPS

29
27
26
25
23
22
21
20
19
18
17
16
15
14
13
12
11
10
9
8
7
6
5
4
3
2

14.020.10 BIRKETT ARTERY FORCEPS STRAIGHT 7.5" (19CM)

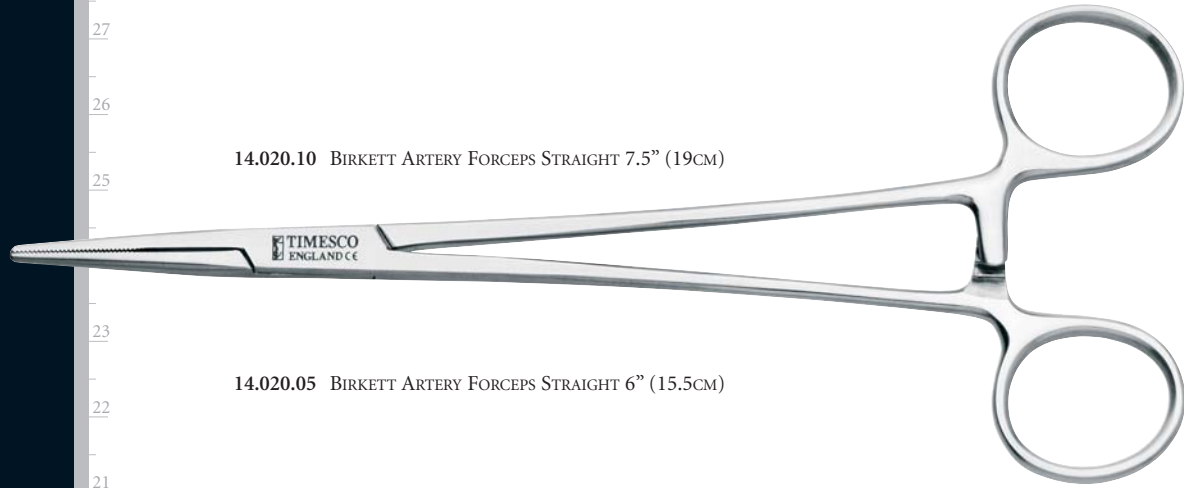

14.020.05 BIRKETT ARTERY FORCEPS STRAIGHT 6" (15.5CM)

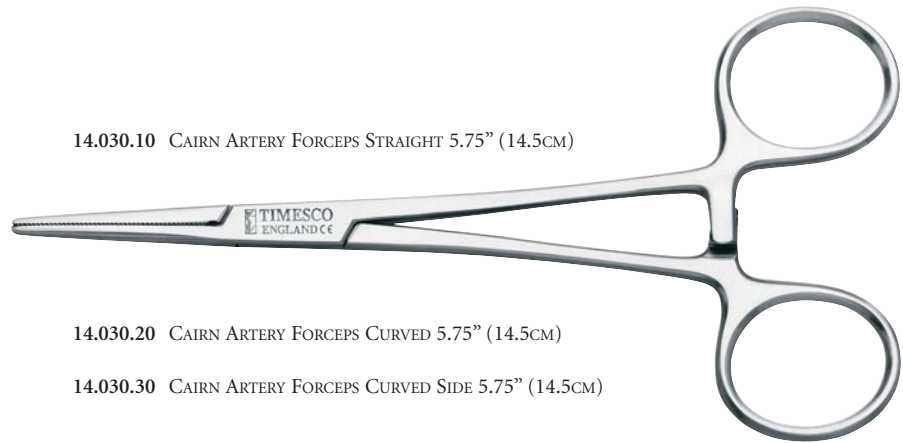

14.030.10 CAIRN ARTERY FORCEPS STRAIGHT 5.75" (14.5CM)



14.030.20 CAIRN ARTERY FORCEPS CURVED 5.75" (14.5CM)

14.030.30 CAIRN ARTERY FORCEPS CURVED SIDE 5.75" (14.5CM)

14.070.10 CRILE ARTERY FORCEPS STRAIGHT 5.5" (14CM)



14.070.20 CRILE ARTERY FORCEPS STRAIGHT 6.5" (16.5CM)

14.072.10 CRILE ARTERY FORCEPS STRAIGHT 5.5" (14CM) 1 X 2 TEETH

14.070.30 CRILE ARTERY FORCEPS CURVED 5.5" (14CM)

14.070.40 CRILE ARTERY FORCEPS CURVED 6.5" (16.5CM)

14.080.10 CUSHING ARTERY FORCEPS STRAIGHT 5.75" (14.5CM)

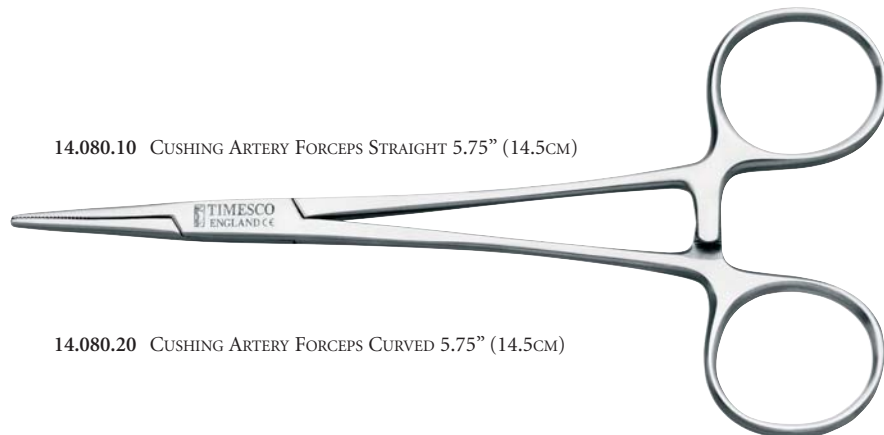

14.080.20 CUSHING ARTERY FORCEPS CURVED 5.75" (14.5CM)



ARTERY FORCEPS

10
9
8
7
6
5
4
3
2
1

14.090.10 DENIS BROWN TONSIL ARTERY FORCEPS ANGLED 8" (20CM)

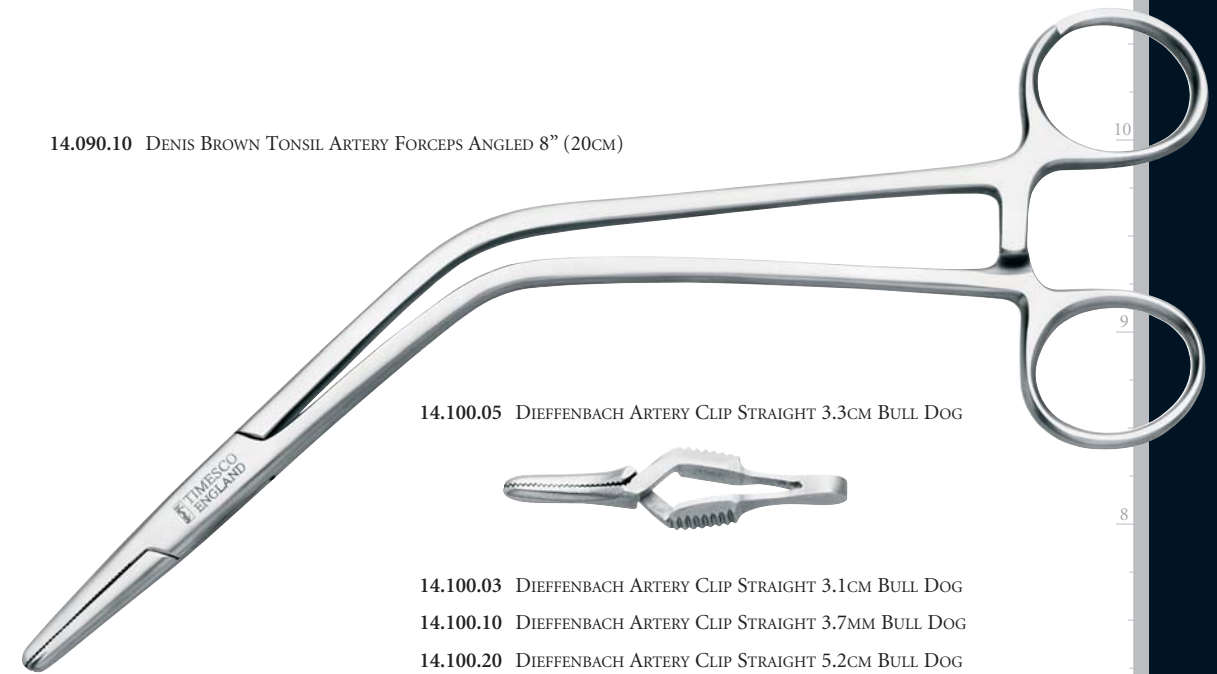

14.100.05 DIEFFENBACH ARTERY CLIP STRAIGHT 3.3CM BULL DOG



14.100.03 DIEFFENBACH ARTERY CLIP STRAIGHT 3.1CM BULL DOG

14.100.10 DIEFFENBACH ARTERY CLIP STRAIGHT 3.7MM BULL DOG

14.100.20 DIEFFENBACH ARTERY CLIP STRAIGHT 5.2CM BULL DOG

14.100.40 DIEFFENBACH ARTERY CLIP STRAIGHT 7.7CM BULL DOG

14.140.20 DUNHILL ARTERY FORCEPS CURVED 5" (13CM)

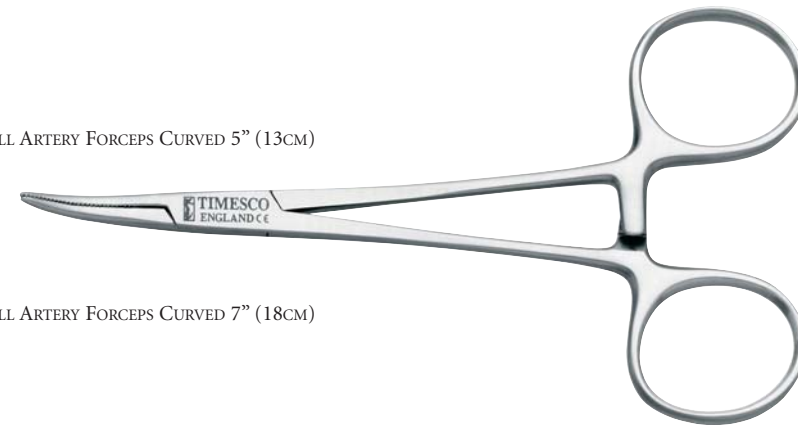

14.140.30 DUNHILL ARTERY FORCEPS CURVED 7" (18CM)

14.180.20 KELLY ARTERY FORCEPS STRAIGHT 6.5" (16.5CM)



14.180.10 KELLY ARTERY FORCEPS STRAIGHT 5.5" (14CM)

14.180.30 KELLY ARTERY FORCEPS CURVED 5.5" (14CM)

14.180.40 KELLY ARTERY FORCEPS CURVED 6.5" (16.5CM)

14.190.10 KELLY FRASER ARTERY FORCEPS STRAIGHT 7" (18CM)

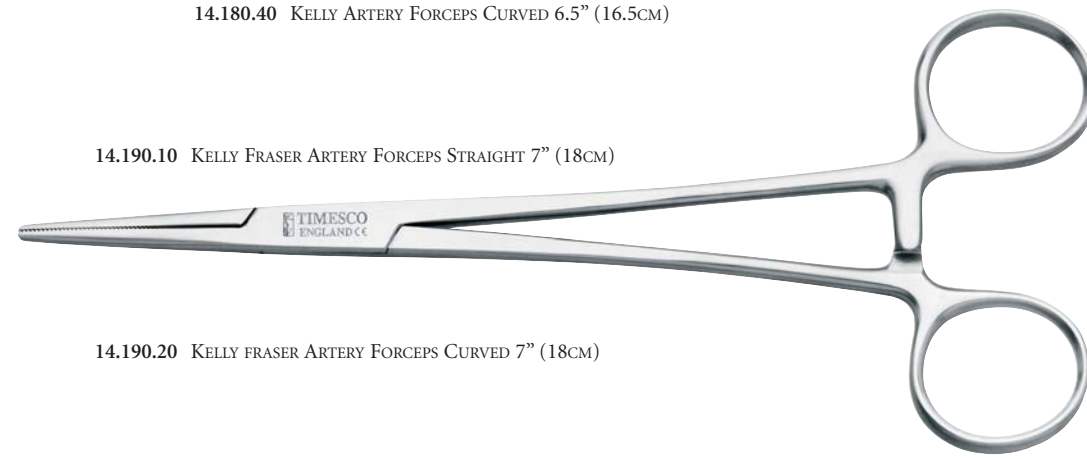

14.190.20 KELLY FRASER ARTERY FORCEPS CURVED 7" (18CM)

14.200.10 KILNER ARTERY FORCEPS STRAIGHT 5.75" (14.5CM) PROVIDENCE



14.240.10 LLOYD DAVIES ARTERY FORCEPS SEMI CURVED 10" (25.5CM)

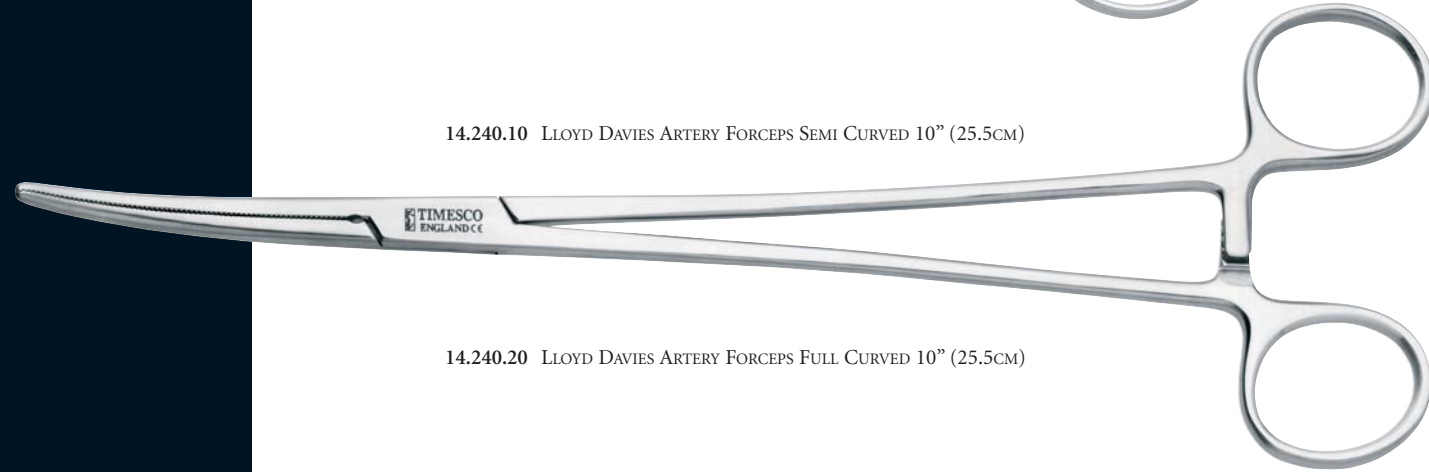

14.240.20 LLOYD DAVIES ARTERY FORCEPS FULL CURVED 10" (25.5CM)

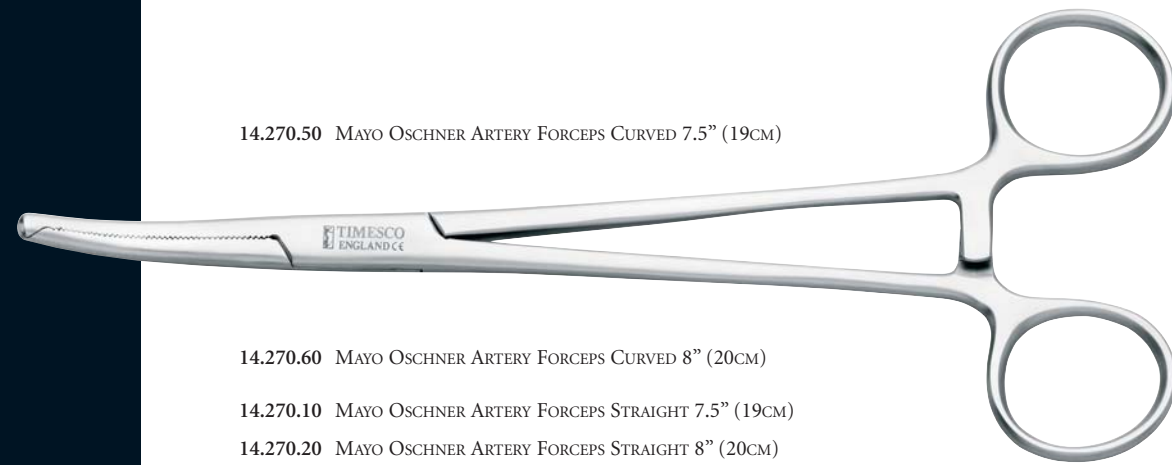

14.270.50 MAYO OSCHNER ARTERY FORCEPS CURVED 7.5" (19CM)



14.270.60 MAYO OSCHNER ARTERY FORCEPS CURVED 8" (20CM)

14.270.10 MAYO OSCHNER ARTERY FORCEPS STRAIGHT 7.5" (19CM)

14.270.20 MAYO OSCHNER ARTERY FORCEPS STRAIGHT 8" (20CM)

14.370.10 MOYNIHAN ARTERY FORCEPS STRAIGHT 5.75" (14.5CM)



14.370.20 MOYNIHAN ARTERY FORCEPS CURVED 5.75" (14.5CM)

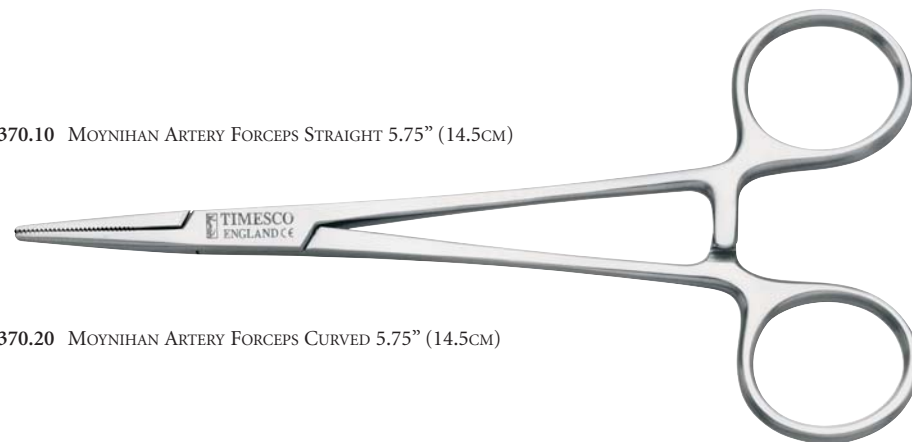

14.325.20 HALSTEAD MOSQUITO ARTERY FORCEPS STRAIGHT 5" (13CM) STANDARD

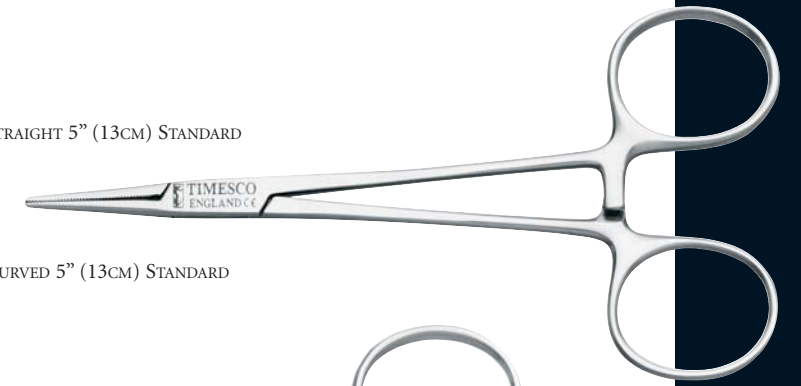

14.325.40 HALSTEAD MOSQUITO ARTERY FORCEPS CURVED 5" (13CM) STANDARD

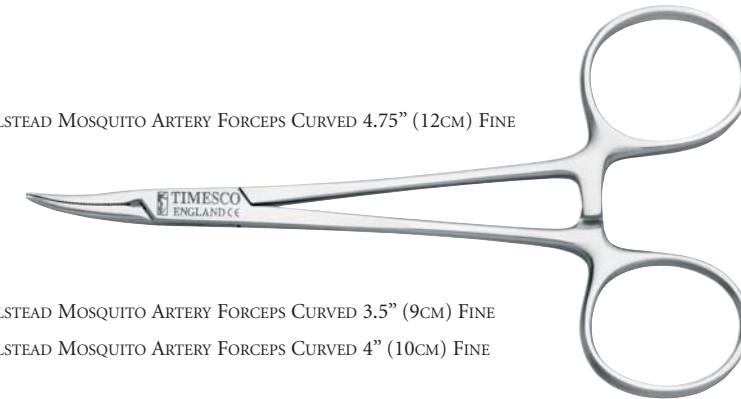

14.320.80 HALSTEAD MOSQUITO ARTERY FORCEPS CURVED 4.75" (12CM) FINE

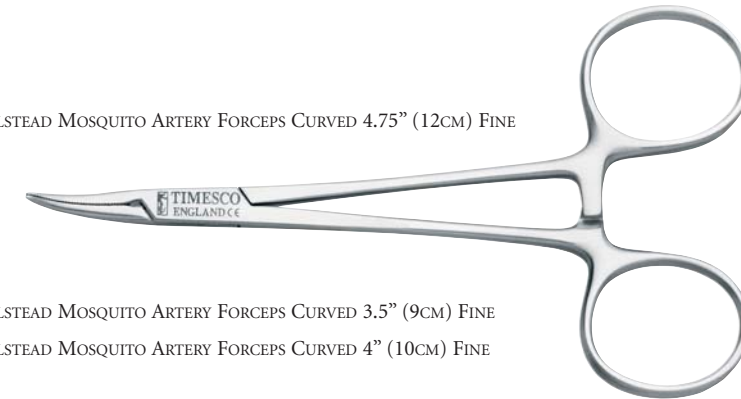

14.320.60 HALSTEAD MOSQUITO ARTERY FORCEPS CURVED 3.5" (9CM) FINE

14.320.70 HALSTEAD MOSQUITO ARTERY FORCEPS CURVED 4" (10CM) FINE

14.400.20 ROBERTS ARTERY FORCEPS CURVED 9" (23CM)

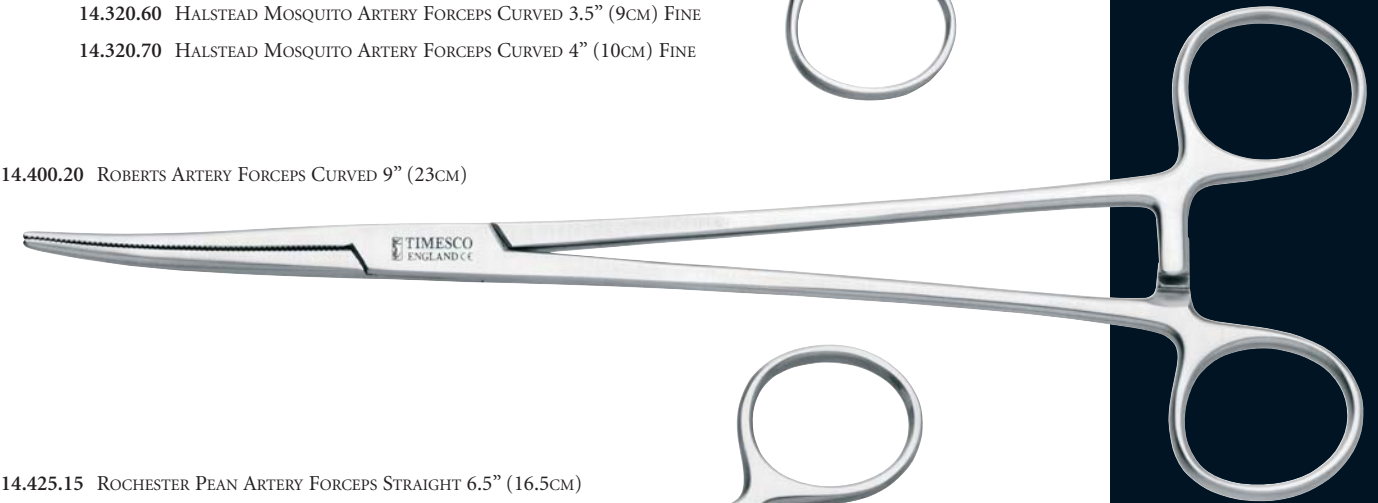

14.425.15 ROCHESTER PEAN ARTERY FORCEPS STRAIGHT 6.5" (16.5CM)

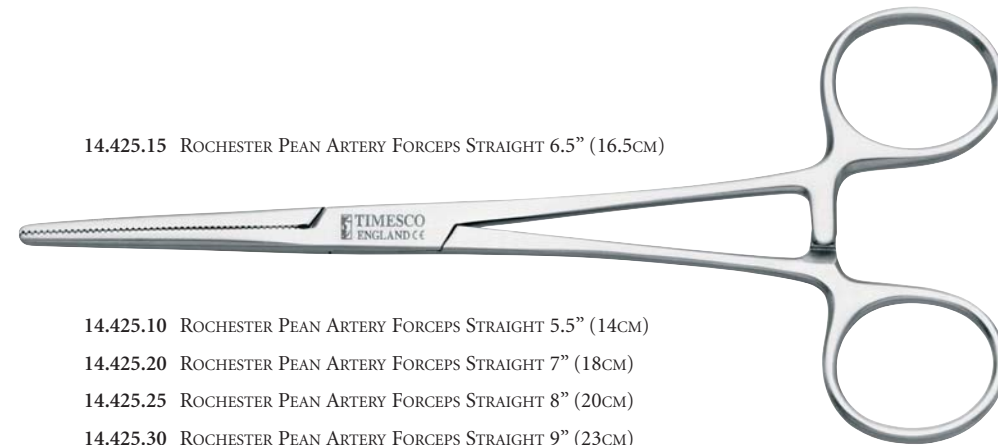

14.425.10 ROCHESTER PEAN ARTERY FORCEPS STRAIGHT 5.5" (14CM)

14.425.20 ROCHESTER PEAN ARTERY FORCEPS STRAIGHT 7" (18CM)

14.425.25 ROCHESTER PEAN ARTERY FORCEPS STRAIGHT 8" (20CM)

14.425.30 ROCHESTER PEAN ARTERY FORCEPS STRAIGHT 9" (23CM)

14.425.50 ROCHESTER PEAN ARTERY FORCEPS CURVED 5.5" (14CM)

14.425.55 ROCHESTER PEAN ARTERY FORCEPS CURVED 6.5" (16.5CM)

14.425.60 ROCHESTER PEAN ARTERY FORCEPS CURVED 7" (18CM)

14.430.10 SAWTELL ARTERY FORCEPS CURVED 7" (18CM)

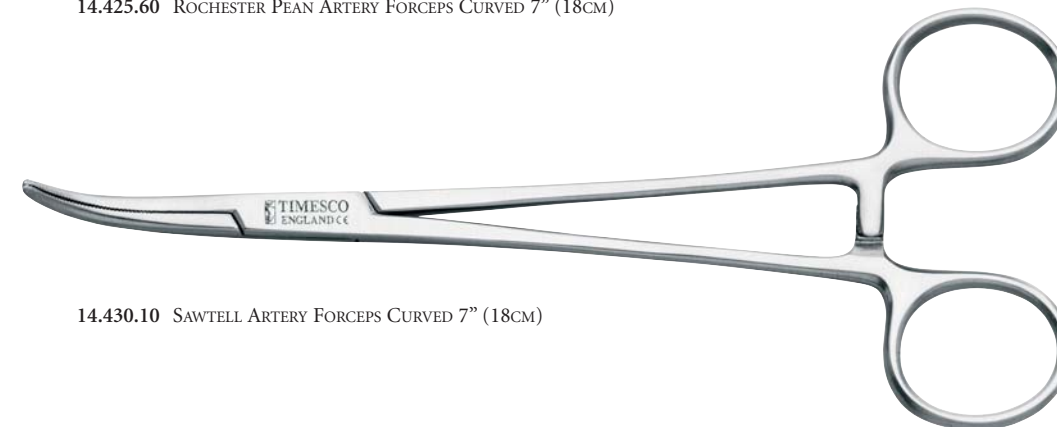

15.425.10 LONDON VAGINAL RETRACTOR 8" (20CM) BLADE SIZE 1" x 3.5" (2.5CM x 9CM)



15.440.20 ST. MARKS (LLOYD DAVIS) RETRACTOR LONG BLADE TAPERED

15.440.30 ST. MARKS (LLOYD DAVIS) RETRACTOR LONG BLADE TAPERED LIP

15.440.40 ST. MARKS (LLOYD DAVIS) RETRACTOR 9" (23CM) BLADE TAPERED

15.440.10 ST. MARKS (LLOYD DAVIES) RETRACTOR SHORT BLADE

15.440.15 ST. MARKS (LLOYD DAVIES) RETRACTOR 5.25" (13.5CM) BLADE WITH LIP

15.490.10 MOYNIHAN RETRACTOR 8.5" (21.5CM) BLADE SIZE 1/2" x 7/8" (1.25CM x 2CM)



15.640.90 VOLKMAN RETRACTOR 4 PRONG BLUNT 8.5" (21.5CM)



15.640.60 VOLKMAN RETRACTOR 1 PRONG BLUNT 8.5" (21.5CM)

15.640.70 VOLKMAN RETRACTOR 2 PRONG BLUNT 8.5" (21.5CM)

15.640.80 VOLKMAN RETRACTOR 3 PRONG BLUNT 8.5" (21.5CM)

15.640.95 VOLKMAN RETRACTOR 6 PRONG BLUNT 8.5" (21.5CM)

15.640.10 VOLKMAN RETRACTOR 1 PRONG SHARP 8.5" (21.5CM)

15.640.20 VOLKMAN RETRACTOR 2 PRONG SHARP 8.5" (21.5CM)

15.640.30 VOLKMAN RETRACTOR 3 PRONG SHARP 8.5" (21.5CM)

15.640.40 VOLKMAN RETRACTOR 4 PRONG SHARP 8.5" (21.5CM)

15.640.50 VOLKMAN RETRACTOR 6 PRONG SHARP 8.5" (21.5CM)

15.220.10 DOYEN ABDOMINAL RETRACTOR RING HANDLE BLADE WIDTH 3.5" (9CM)



15.220.20 DOYEN ABDOMINAL RETRACTOR RING HANDLE BLADE WIDTH 4" (10CM)

15.220.30 DOYEN ABDOMINAL RETRACTOR RING HANDLE BLADE WIDTH 4.5" (11.5CM)

15.205.50 DEAVER RETRACTOR HOLLOW HANDLE 2"W x 12"L (5CM x 30.5CM)

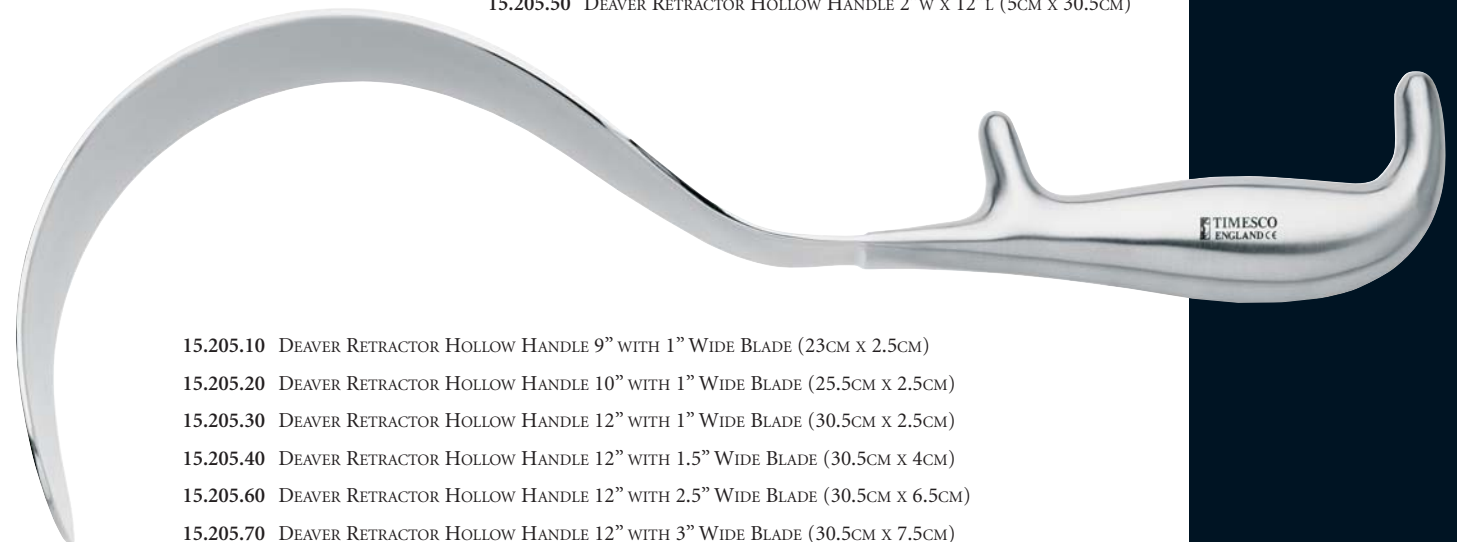

15.205.10 DEAVER RETRACTOR HOLLOW HANDLE 9" WITH 1" WIDE BLADE (23CM x 2.5CM)

15.205.20 DEAVER RETRACTOR HOLLOW HANDLE 10" WITH 1" WIDE BLADE (25.5CM x 2.5CM)

15.205.30 DEAVER RETRACTOR HOLLOW HANDLE 12" WITH 1" WIDE BLADE (30.5CM x 2.5CM)

15.205.40 DEAVER RETRACTOR HOLLOW HANDLE 12" WITH 1.5" WIDE BLADE (30.5CM x 4CM)

15.205.60 DEAVER RETRACTOR HOLLOW HANDLE 12" WITH 2.5" WIDE BLADE (30.5CM x 6.5CM)

15.205.70 DEAVER RETRACTOR HOLLOW HANDLE 12" WITH 3" WIDE BLADE (30.5CM x 7.5CM)

15.390.10 KELLY RETRACTOR 10.75" (27CM) BLADE SIZE 1.5" X 7.5" (4CM X 19CM)



15.390.20 KELLY RETRACTOR 10.75" (27CM) BLADE SIZE 2.25" X 7.5" (5.75CM X 19CM)



15.405.10 KILNER RETRACTOR DOUBLE ENDED 5" (12.5CM) BLADE WIDTHS 0.75" AND 1" (1.9CM AND 2.5CM)

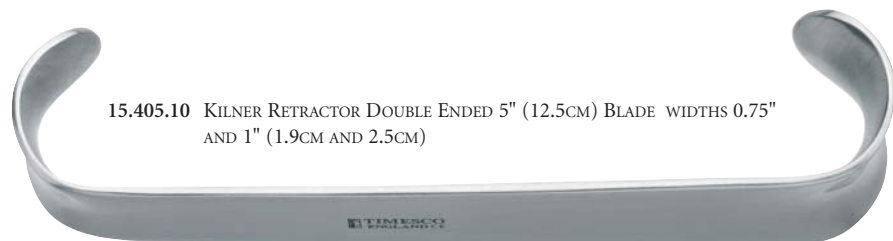

15.405.20 KILNER RETRACTOR DOUBLE ENDED 5" (12.5CM) BLADE WIDTHS 0.9" AND 1" (2.25CM AND 2.5CM)

15.405.30 KILNER RETRACTOR DOUBLE ENDED 5" (12.5CM) BLADE WIDTHS 1.25" AND 1.5" (3.1CM AND 3.75CM)

15.405.50 KILNER RETRACTOR DOUBLE ENDED 7" (17.5CM) BLADE WIDTHS 0.75" AND 1" (1.9CM AND 2.5CM)

15.480.20 MORRIS RETRACTOR DOUBLE ENDED 9" (23CM) BOTH BLADE SIZES 1.25" X 1.5" (3.2CM X 3.8CM)

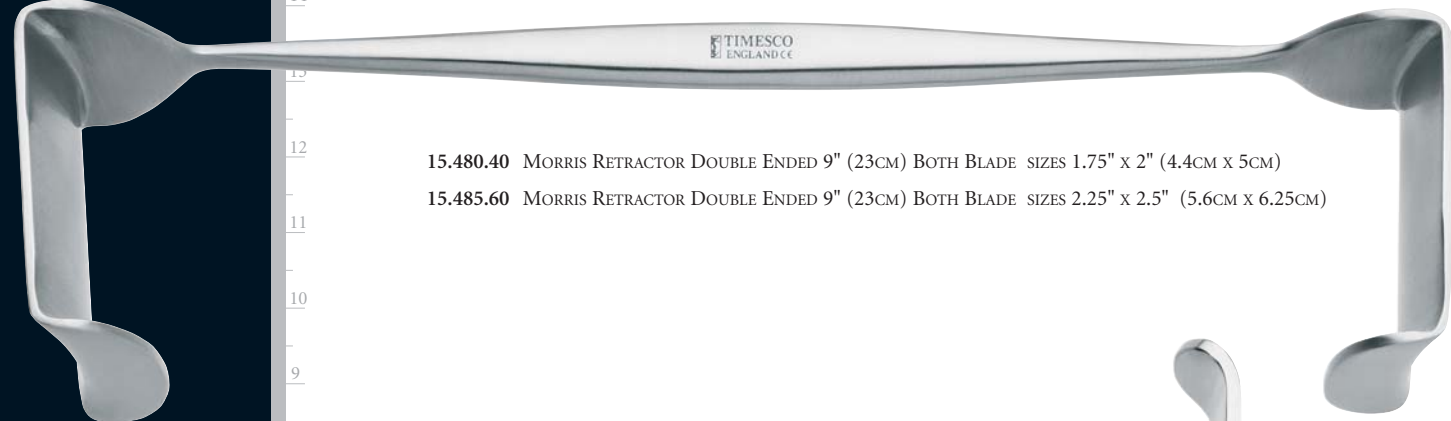

15.480.40 MORRIS RETRACTOR DOUBLE ENDED 9" (23CM) BOTH BLADE SIZES 1.75" X 2" (4.4CM X 5CM)

15.485.60 MORRIS RETRACTOR DOUBLE ENDED 9" (23CM) BOTH BLADE SIZES 2.25" X 2.5" (5.6CM X 6.25CM)

15.180.10 CZERNY RETRACTOR DOUBLE ENDED 7" (18CM)

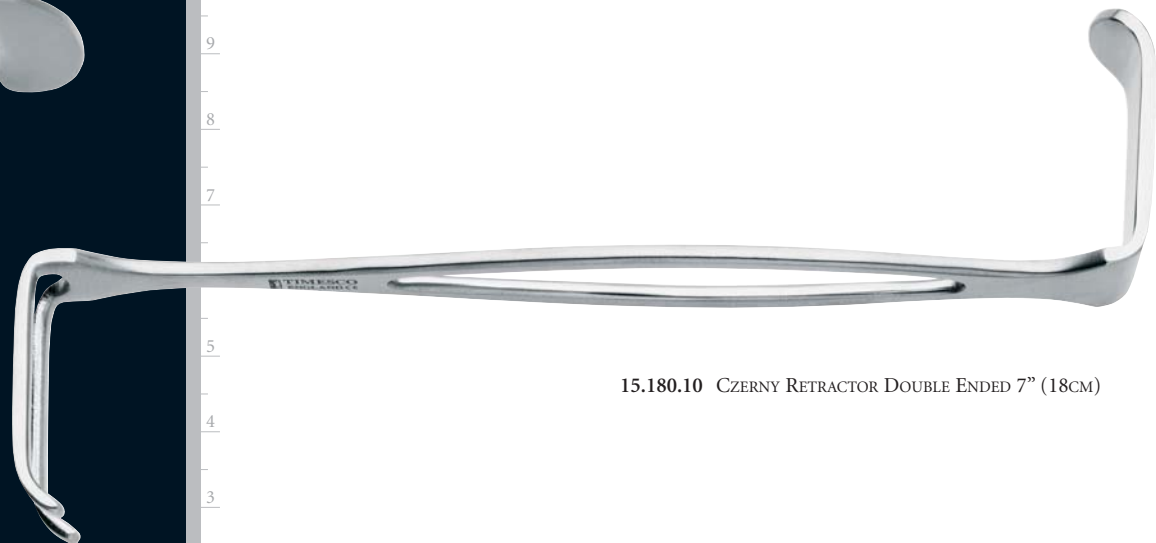

15.675.10 WEISLANDER RETRACTOR SELF RETAINING 3 X 4 PRONG BLUNT 5.5" (14CM)



15.675.15 WEISLANDER RETRACTOR SELF RETAINING 3 X 4 PRONG BLUNT 6.5" (16.5CM)



15.620.10 TRAVERS RETRACTOR SELF RETAINING 4 X 5 PRONG BLUNT 8" (20CM)

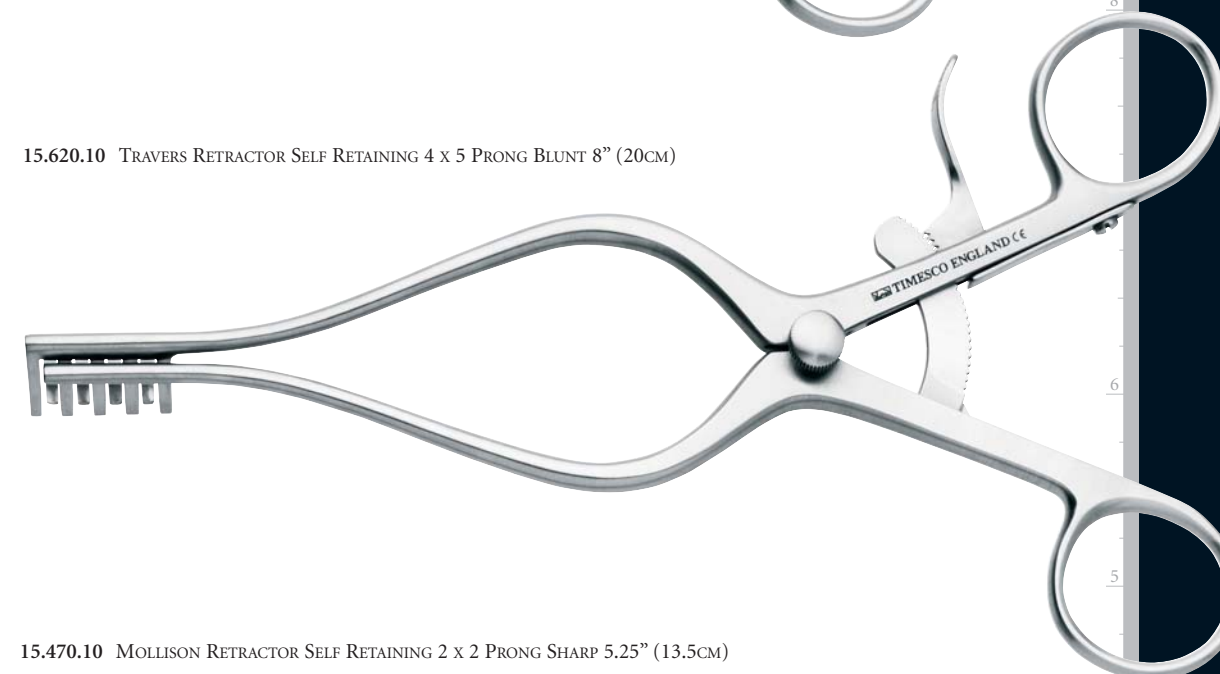

15.470.10 MOLLISON RETRACTOR SELF RETAINING 2 X 2 PRONG SHARP 5.25" (13.5CM)

15.470.20 MOLLISON RETRACTOR SELF RETAINING 4 X 4 PRONG SHARP 6.5" (16.5CM)

15.470.30 MOLLISON RETRACTOR SELF RETAINING 4 X 4 PRONG SHARP 7" (18CM)

15.500.10 NORFOLK AND NORWICH RETRACTOR SELF RETAINING 8.5" (21.5CM)



- 15.060.10 BALFOUR RETRACTOR SELF RETAINING INFANT
- 15.060.20 BALFOUR RETRACTOR SELF RETAINING CHILD
- 15.060.40 BALFOUR RETRACTOR SELF RETAINING ADULT
- 15.060.45 BALFOUR RETRACTOR SELF RETAINING ADULT
CENTRE BLADE ONLY
- 15.060.50 BALFOUR RETRACTOR SELF RETAINING
EXTRA LARGE ADULT

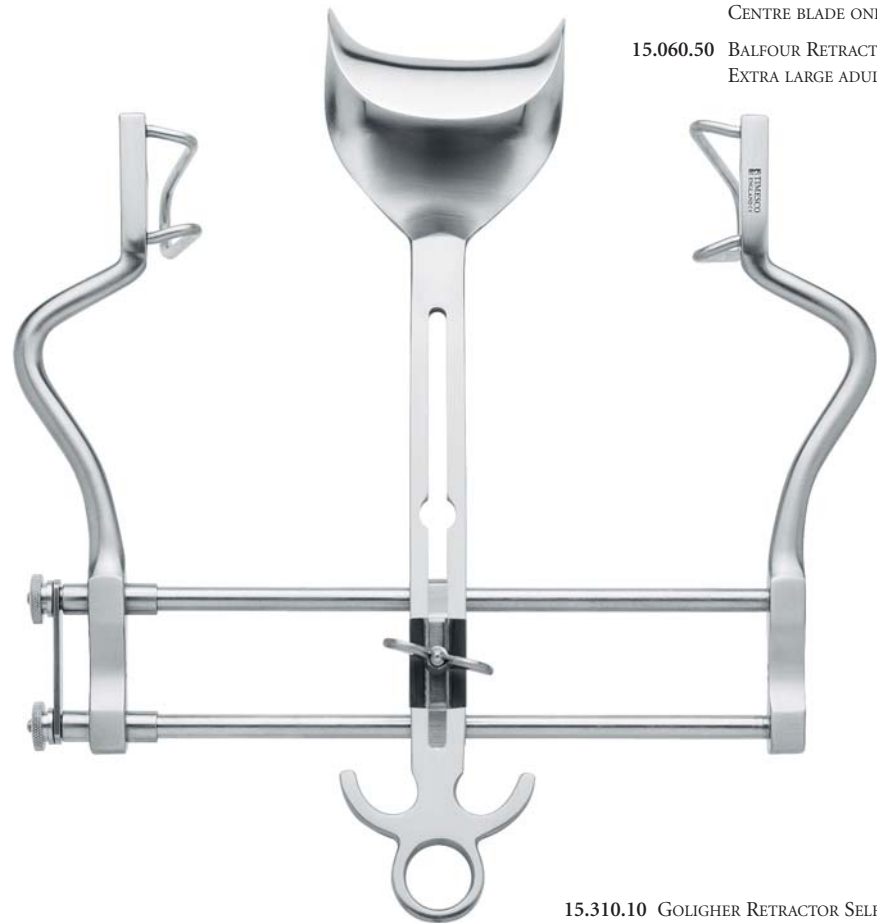

- 15.310.10 GOLIGHER RETRACTOR SELF RETAINING FRAME AND 6 BLADES
- 15.310.20 GOLIGHER RETRACTOR SIDE BLADE SMALL
- 15.310.30 GOLIGHER RETRACTOR SIDE BLADE LARGE
- 15.310.40 GOLIGHER RETRACTOR CENTRE BLADE SMALL
- 15.310.50 GOLIGHER RETRACTOR CENTRE BLADE LARGE



- 15.315.10 GOSSET RETRACTOR SELF RETAINING SMALL BLADES
- 15.315.20 GOSSET RETRACTOR SELF RETAINING LARGE BLADES



- 15.380.10 JOLL THYROID RETRACTOR SELF RETAINING 6" (15.5CM)



RETRACTORS & SKIN HOOKS

15.020.10 ALMS SKIN RETRACTOR SELF RETAINING SHARP PRONGS 3" (7.5CM)

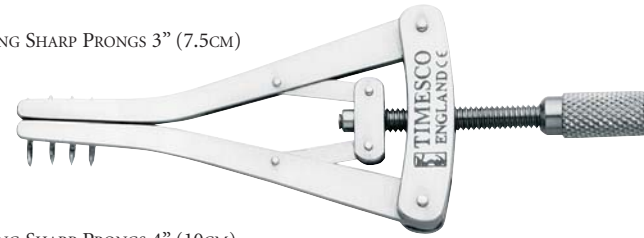

15.030.10 ALMS SKIN RETRACTOR SELF RETAINING SHARP PRONGS 4" (10CM)

15.020.20 ALM SKIN RETRACTOR SELF RETAINING BLUNT PRONGS 3" (7.5CM)

15.030.20 ALM SKIN RETRACTOR SELF RETAINING BLUNT PRONGS 4" (10CM)

15.175.10 CUSHING VEIN + NERVE RETRACTOR 8MM BLADE 9" (23CM)



15.910.10 GILLIES SKIN HOOK STANDARD 6.5" (16.5CM)



15.910.20 GILLIES SKIN HOOK HALF SIZE 6.5" (16.5CM)

15.940.10 MCINDOE SKIN HOOK 2 PRONG 9MM X 6.5" (15.5CM)



15.940.20 MCINDOE SKIN HOOK 2 PRONG 10MM X 6.5" (15.5CM)

15.940.30 MCLNDOE SKIN HOOK 2 PRONG 11MM X 6.5" (15.5CM)

INSTRUMENT PINS

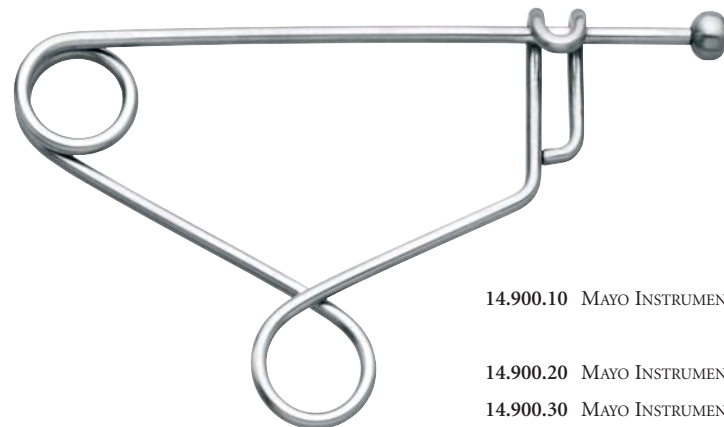

14.900.10 MAYO INSTRUMENT PIN 4.5" (11.5CM)

14.900.20 MAYO INSTRUMENT PIN DOUBLE 5" (13CM)

14.900.30 MAYO INSTRUMENT PIN 6" (15.5CM)

TOWEL CLIPS

16.540.20 MOYNIHAN TOWEL FORCEPS SINGLE TETRA 7.5" (19CM)

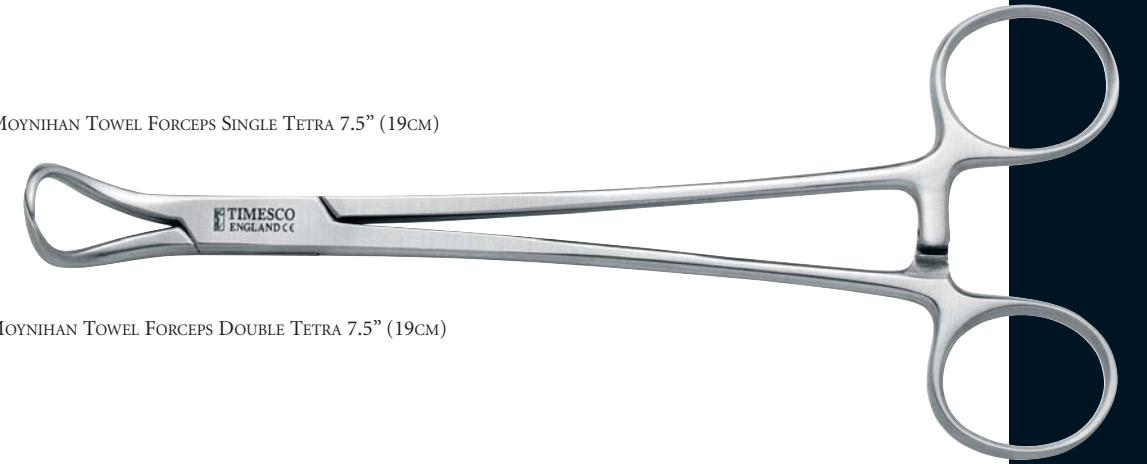

16.540.40 MOYNIHAN TOWEL FORCEPS DOUBLE TETRA 7.5" (19CM)

16.455.10 CROSS ACTION TOWEL CLIP ATRAUMATIC 3.5" (9CM) BALL & SOCKET



16.510.10 BACHAUSE TOWEL FORCEP ATRAUMA 3.75" (9.5CM)



16.510.20 BACHAUSE TOWEL FORCEP ATRAUMA 5.25" (13.5CM)

SPONGE HOLDERS

16.100.40 RAMPLEY SPONGE HOLDING FORCEPS 9.5" (24CM)



16.100.30 RAMPLEY SPONGE HOLDING FORCEPS 7" (18CM)

TISSUE FORCEPS

29

27

26

25

24

23

22

21

20

19

18

17

16

15

14

13

12

11

10

9

8

7

6

5

4

3

2

23

CM

16.695.10 LITTLEWOOD TISSUE FORCEPS 7.5" (19CM)

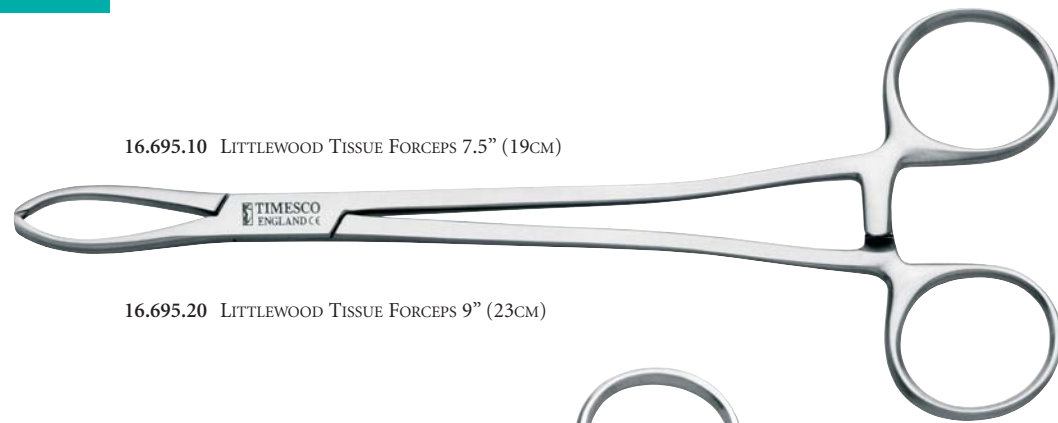

16.695.20 LITTLEWOOD TISSUE FORCEPS 9" (23CM)

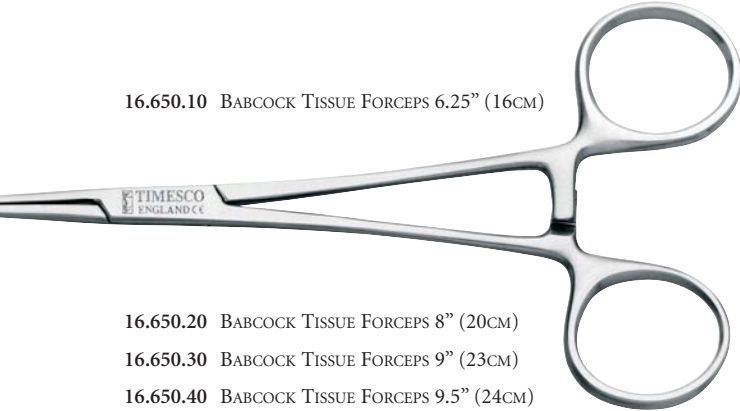

16.650.10 BABCOCK TISSUE FORCEPS 6.25" (16CM)



16.650.20 BABCOCK TISSUE FORCEPS 8" (20CM)

16.650.30 BABCOCK TISSUE FORCEPS 9" (23CM)

16.650.40 BABCOCK TISSUE FORCEPS 9.5" (24CM)

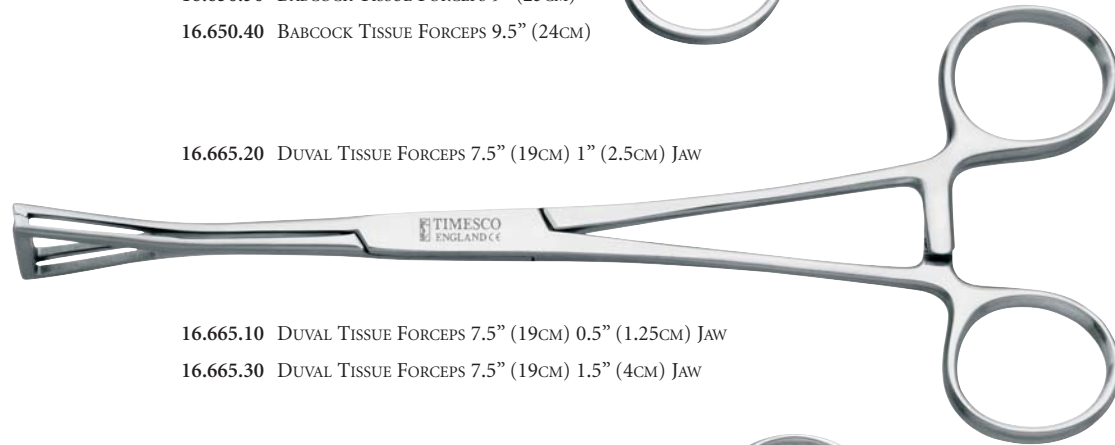

16.665.20 DUVAL TISSUE FORCEPS 7.5" (19CM) 1" (2.5CM) JAW

16.665.10 DUVAL TISSUE FORCEPS 7.5" (19CM) 0.5" (1.25CM) JAW

16.665.30 DUVAL TISSUE FORCEPS 7.5" (19CM) 1.5" (4CM) JAW

16.675.10 JUDD ALLIS TISSUE FORCEPS 7.75" (19.5CM)

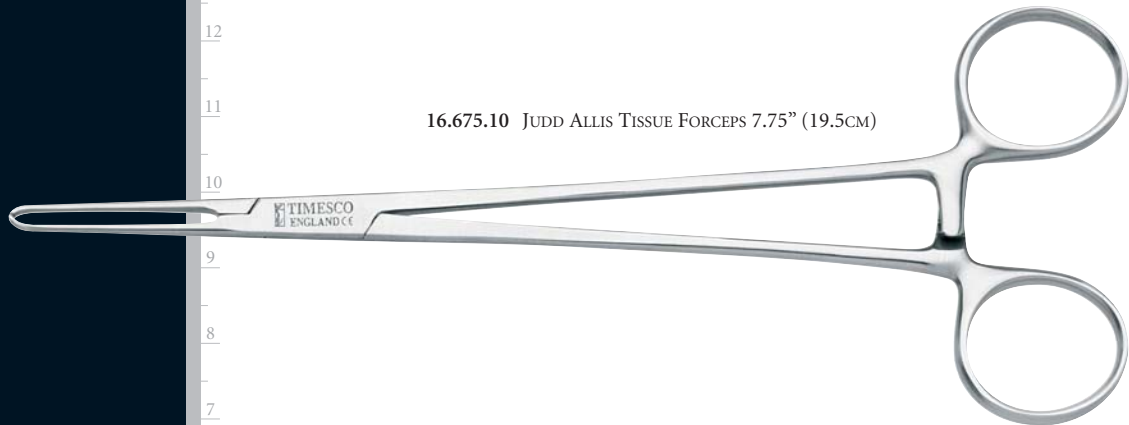

16.600.20 ALLIS TISSUE FORCEPS 6" (15.5CM) 3X4TH

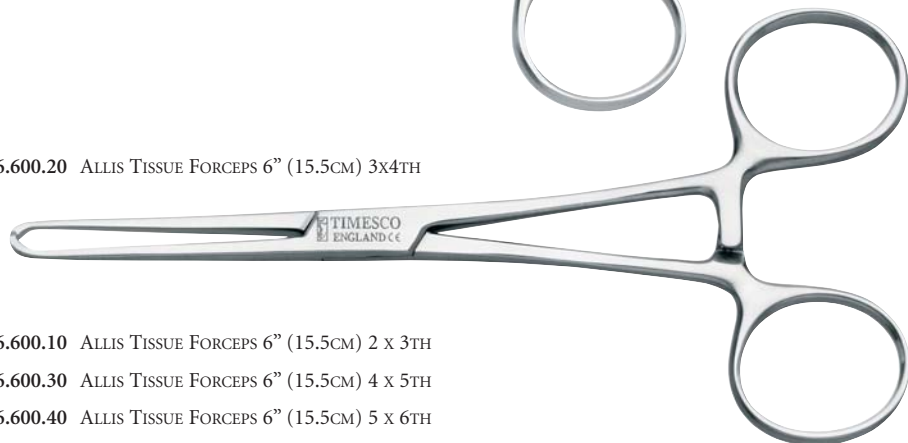

16.600.10 ALLIS TISSUE FORCEPS 6" (15.5CM) 2 X 3TH

16.600.30 ALLIS TISSUE FORCEPS 6" (15.5CM) 4 X 5TH

16.600.40 ALLIS TISSUE FORCEPS 6" (15.5CM) 5 X 6TH

16.600.50 ALLIS TISSUE FORCEPS 6" (15.5CM) 6 X 7TH

16.600.60 ALLIS TISSUE FORCEPS 6" (15.5CM) 7 X 8TH



TISSUE FORCEPS

16.640.10 ALLIS AMERICAN TISSUE FORCEPS 5.75" (14.5CM) 3X4TH



16.685.20 LANE TISSUE FORCEPS 6" (15.5CM) 1 X 2 TEETH



16.685.10 LANE TISSUE FORCEPS 5" (13CM) 1 X 2 TEETH

16.685.30 LANE TISSUE FORCEPS 7.75" (19.5CM) 1 X 2 TEETH

CHOLECYSTECTOMY FORCEPS

51.595.20 MOYNIHAN CHOLECYSTECTOMY FORCEPS CURVED 8.75" (22CM)

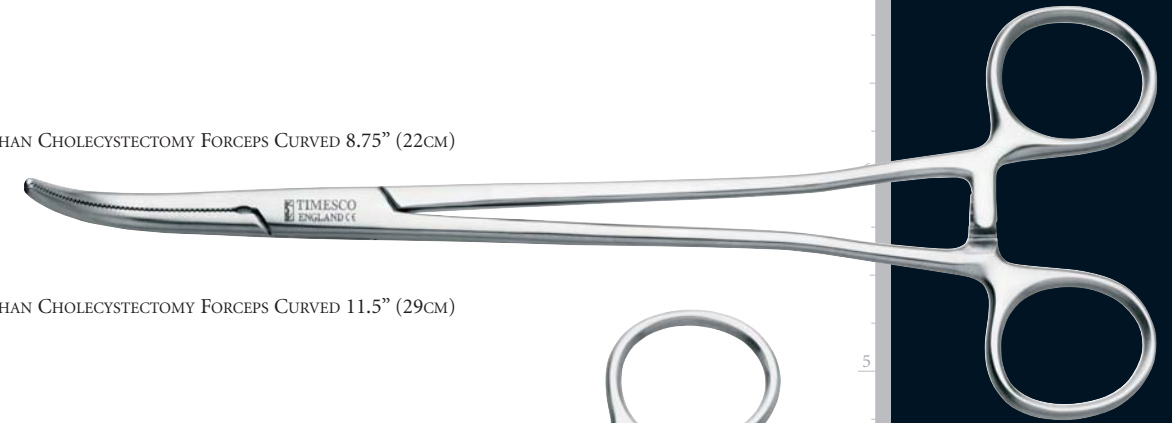

51.595.60 MOYNIHAN CHOLECYSTECTOMY FORCEPS CURVED 11.5" (29CM)

51.590.20 LAHEY CHOLECYSTECTOMY FORCEPS CURVED 7.75" (19.5CM)

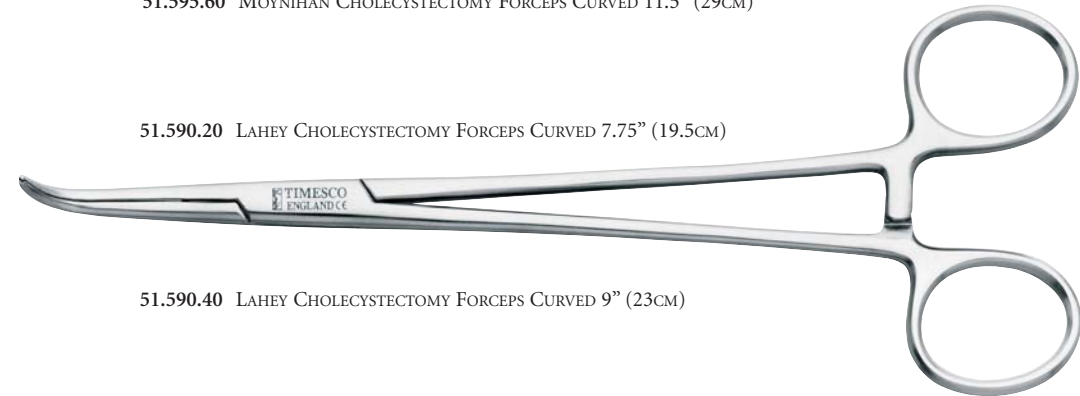

51.590.40 LAHEY CHOLECYSTECTOMY FORCEPS CURVED 9" (23CM)

DISSECTORS

20.675.10 MACDONALD DISSECTOR 7.5" (19CM) DOUBLE ENDED



20.700.20 WATSON CHEYNE DISSECTOR 7" (18CM) DOUBLE ENDED



20.700.10 WATSON CHEYNE DISSECTOR 5" (13CM) DOUBLE ENDED

24

INCHES

17.060.10 CRILE MURRAY NEEDLE HOLDER 6" (15.5CM)



17.070.20 CRILE WOOD NEEDLE HOLDER 7" (18CM)

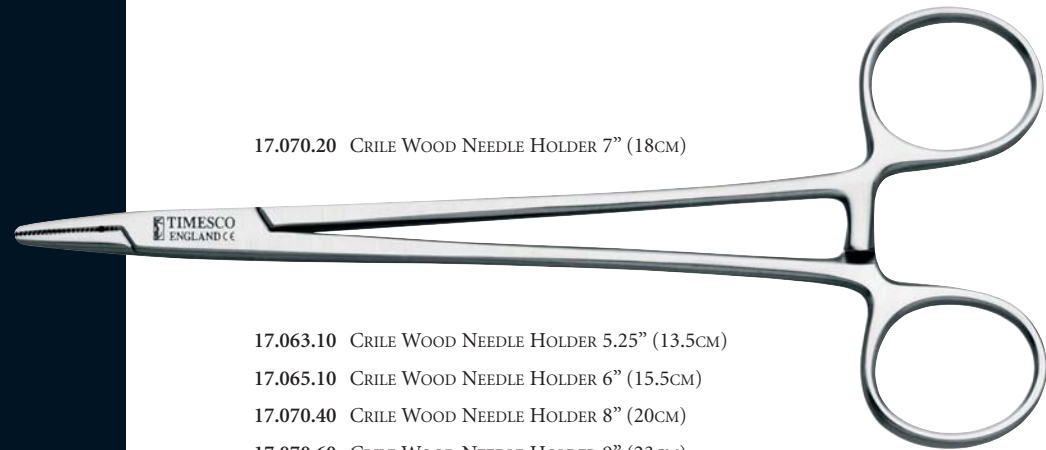

17.063.10 CRILE WOOD NEEDLE HOLDER 5.25" (13.5CM)

17.065.10 CRILE WOOD NEEDLE HOLDER 6" (15.5CM)

17.070.40 CRILE WOOD NEEDLE HOLDER 8" (20CM)

17.070.60 CRILE WOOD NEEDLE HOLDER 9" (23CM)

17.070.80 CRILE WOOD NEEDLE HOLDER 10" (25.5CM)

17.075.10 DERF NEEDLE HOLDER 4.75" (12CM)

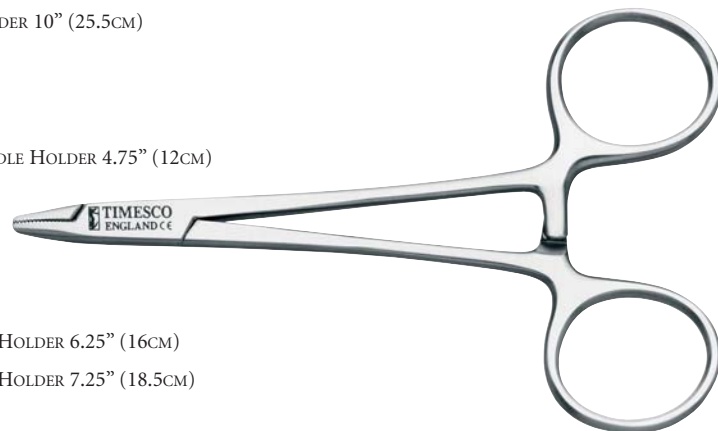

17.080.10 DUNHILL (MAYO) NEEDLE HOLDER 6.25" (16CM)

17.080.20 DUNHILL (MAYO) NEEDLE HOLDER 7.25" (18.5CM)

17.110.10 HALSEY NEEDLE HOLDER SMOOTH JAW 5" (13CM)



17.125.20 KILNER NEEDLE HOLDER 5.25" (13.5CM)



17.125.30 KILNER NEEDLE HOLDER 6.25" (16CM)

17.125.50 KILNER NEEDLE HOLDER LAMINATED JAW 5.25" (13.5CM)

17.170.10 MAYO HEGAR NEEDLE HOLDER 5.5" (14CM)

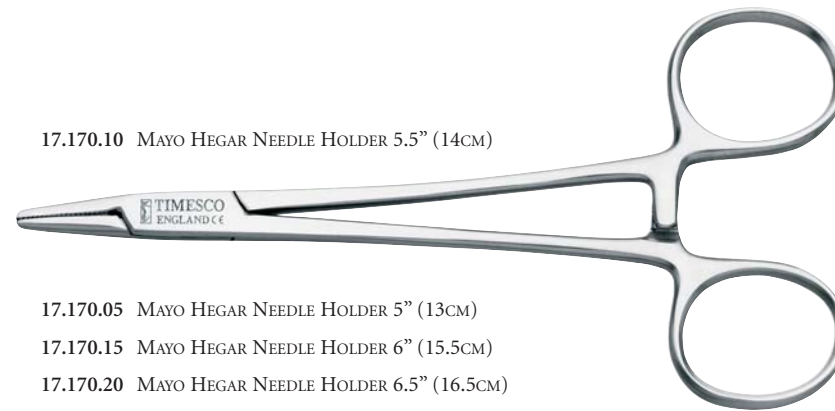

17.170.05 MAYO HEGAR NEEDLE HOLDER 5" (13CM)

17.170.15 MAYO HEGAR NEEDLE HOLDER 6" (15.5CM)

17.170.20 MAYO HEGAR NEEDLE HOLDER 6.5" (16.5CM)

17.170.25 MAYO HEGAR NEEDLE HOLDER 7" (18CM)

17.170.30 MAYO HEGAR NEEDLE HOLDER 7.5" (19CM)

17.170.35 MAYO HEGAR NEEDLE HOLDER 8" (20CM)

17.170.40 MAYO HEGAR NEEDLE HOLDER 9" (23CM)

17.170.45 MAYO HEGAR NEEDLE HOLDER 10" (25.5CM)

17.170.65 MAYO HEGAR NEEDLE HOLDER 12" (30.5CM)

17.210.20 OLSEN HEGAR NEEDLE HOLDER 7" (18CM)



17.210.10 OLSEN HEGAR NEEDLE HOLDER 5.5" (14CM)

17.210.30 OLSEN HEGAR NEEDLE HOLDER 8" (20CM)

17.345.10 DERF NEEDLE HOLDER 4.75" (12CM) TUNGSTEN CARBIDE



17.330.20 CRILE WOOD NEEDLE HOLDER 7" (18CM) TUNGSTEN CARBIDE

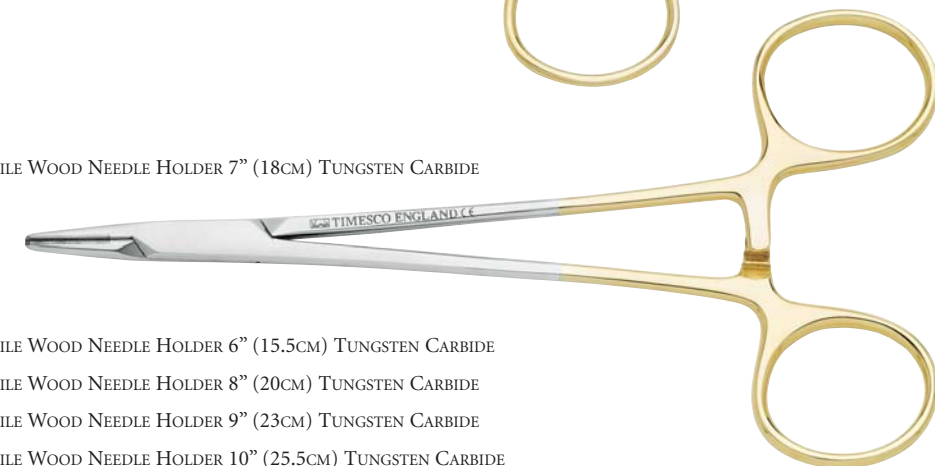

17.330.10 CRILE WOOD NEEDLE HOLDER 6" (15.5CM) TUNGSTEN CARBIDE

17.330.30 CRILE WOOD NEEDLE HOLDER 8" (20CM) TUNGSTEN CARBIDE

17.330.40 CRILE WOOD NEEDLE HOLDER 9" (23CM) TUNGSTEN CARBIDE

17.330.50 CRILE WOOD NEEDLE HOLDER 10" (25.5CM) TUNGSTEN CARBIDE

17.330.60 CRILE WOOD NEEDLE HOLDER 12.25" (31CM) TUNGSTEN CARBIDE

NEEDLE HOLDERS TUNGSTEN CARBIDE

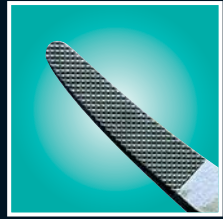

Our Tungsten Carbide needle holders are tipped with especially hardened tungsten inserts with a "diamond" profile for superb grip.

17.340.10 DEBAKEY NEEDLE HOLDER 7" (18CM) TUNGSTEN CARBIDE



17.340.03 DEBAKEY NEEDLE HOLDER 5" (13CM) TUNGSTEN CARBIDE

17.340.05 DEBAKEY NEEDLE HOLDER 6" (15.5CM) TUNGSTEN CARBIDE

17.340.20 DEBAKEY NEEDLE HOLDER 8" (20CM) TUNGSTEN CARBIDE.

17.340.30 DEBAKEY NEEDLE HOLDER 9" (23CM) TUNGSTEN CARBIDE

17.340.40 DEBAKEY NEEDLE HOLDER 10" (25.5CM) TUNGSTEN CARBIDE

17.340.50 DEBAKEY NEEDLE HOLDER 12.25" (31CM) TUNGSTEN CARBIDE

17.355.10 FINOCHIETTO NEEDLE HOLDER 8" (20CM) TUNGSTEN CARBIDE

17.355.20 FINOCHIETTO NEEDLE HOLDER 10.5" (27CM) TUNGSTEN CARBIDE

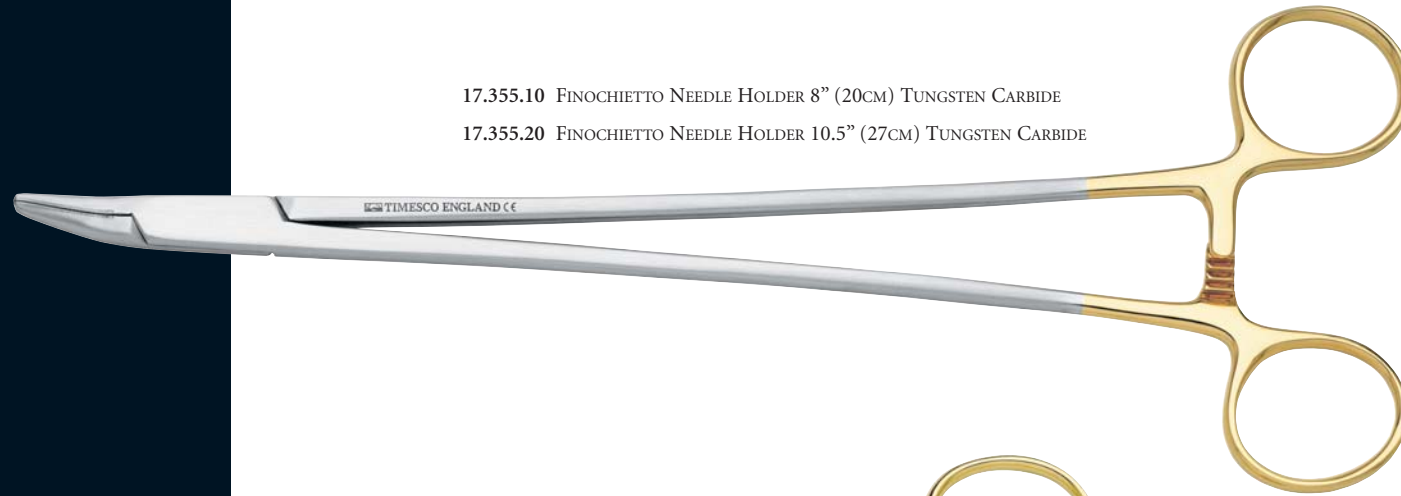

17.390.10 KILNER NEEDLE HOLDER 5.25" (13.5CM) TUNGSTEN CARBIDE

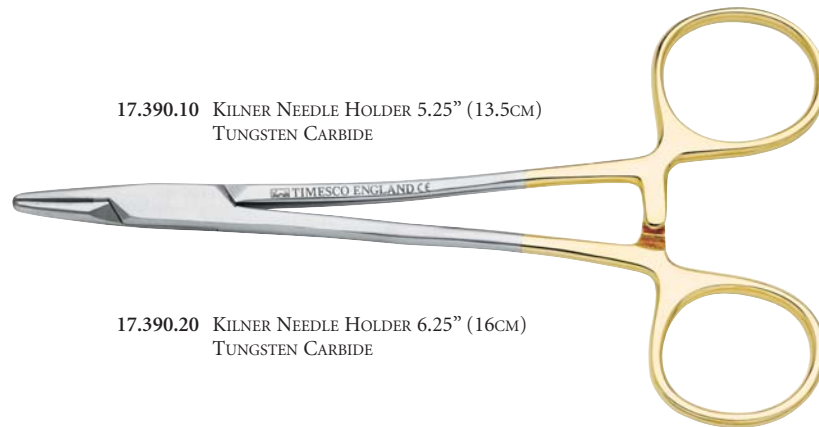

17.390.20 KILNER NEEDLE HOLDER 6.25" (16CM) TUNGSTEN CARBIDE



17.385.10 HEANEY NEEDLE HOLDER 8" (20CM) TUNGSTEN CARBIDE

17.385.15 HEANEY NEEDLE HOLDER 9" (23CM) TUNGSTEN CARBIDE

17.385.20 HEANEY NEEDLE HOLDER 10.5" (27CM) TUNGSTEN CARBIDE

NEEDLE HOLDERS TUNGSTEN CARBIDE

17.320.20 CASTROVIEJO STRAIGHT FLAT HANDLE + LOCK 5.5" (14CM) TUNGSTEN CARBIDE

17.320.40 CASTROVIEJO STRAIGHT FLAT HANDLE + LOCK 7" (18CM) TUNGSTEN CARBIDE

17.320.60 CASTROVIEJO STRAIGHT FLAT HANDLE + LOCK 8.5" (21.5CM) TUNGSTEN CARBIDE



17.320.70 CASTROVIEJO CURVED FLAT HANDLE + LOCK 5.5" (14CM) TUNGSTEN CARBIDE

17.320.80 CASTROVIEJO CURVED FLAT HANDLE + LOCK 7" (18CM) TUNGSTEN CARBIDE

17.320.90 CASTROVIEJO CURVED FLAT HANDLE + LOCK 8.5" (21.5CM) TUNGSTEN CARBIDE

17.323.10 CASTROVIEJO STRAIGHT ROUND HANDLE + LOCK 5.5" (14CM) TUNGSTEN CARBIDE

17.323.20 CASTROVIEJO STRAIGHT ROUND HANDLE + LOCK 7" (18CM) TUNGSTEN CARBIDE

17.323.40 CASTROVIEJO CURVED ROUND HANDLE + LOCK 5.5" (14CM) TUNGSTEN CARBIDE

17.323.50 CASTROVIEJO CURVED ROUND HANDLE + LOCK 7" (18CM) TUNGSTEN CARBIDE

17.410.05 MAYO HEGAR NEEDLE HOLDER 5" (13CM) TUNGSTEN CARBIDE

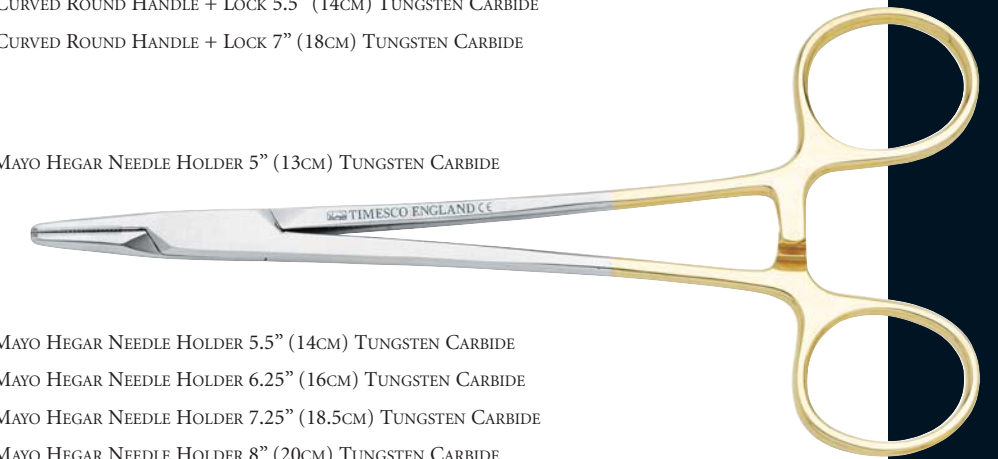

17.410.10 MAYO HEGAR NEEDLE HOLDER 5.5" (14CM) TUNGSTEN CARBIDE

17.410.20 MAYO HEGAR NEEDLE HOLDER 6.25" (16CM) TUNGSTEN CARBIDE

17.410.30 MAYO HEGAR NEEDLE HOLDER 7.25" (18.5CM) TUNGSTEN CARBIDE

17.410.40 MAYO HEGAR NEEDLE HOLDER 8" (20CM) TUNGSTEN CARBIDE

17.410.50 MAYO HEGAR NEEDLE HOLDER 9" (23CM) TUNGSTEN CARBIDE

17.410.60 MAYO HEGAR NEEDLE HOLDER 10" (25.5CM) TUNGSTEN CARBIDE

17.410.70 MAYO HEGAR NEEDLE HOLDER 12" (30.5CM) TUNGSTEN CARBIDE

17.365.20 GILLIES NEEDLE HOLDER 6.25" (16CM) RIGHT HAND TUNGSTEN CARBIDE



17.365.40 GILLIES NEEDLE HOLDER 6.25" (16CM) LEFT HAND TUNGSTEN CARBIDE

17.380.10 HALSEY NEEDLE HOLDER 5" (13CM) SMOOTH TUNGSTEN CARBIDE



Our Gillies Needle Holder also incorporates a scissors cutting edge for convenient suturing and cutting in one instrument.

TROCARS & SUCTION TUBES

21.200.20 TILLEY LICHTWITZ TROCAR COMPLETE 7FG



21.200.10 TILLEY LICHTWITZ TROCAR COMPLETE 5FG

21.200.15 TILLEY LICHTWITZ TROCAR COMPLETE 6FG

21.200.25 TILLEY LICHTWITZ TROCAR COMPLETE 7.5FG

21.200.30 TILLEY LICHTWITZ TROCAR COMPLETE 8FG

21.200.35 TILLEY LICHTWITZ TROCAR COMPLETE 9FG

21.860.10 YANKAUER SUCTION TUBE COMPLETE

21.860.30 YANKAUER SUCTION ROSE END ONLY

21.860.31 YANKAUER SUCTION ROSE END STILLETTE ONLY

21.860.40 YANKAUER SUCTION TUBE END ONLY

21.600.30 FRAZIER SUCTION TUBE 8FG



21.600.20 FRAZIER SUCTION TUBE 7FG

21.600.40 FRAZIER SUCTION TUBE 9FG

21.600.50 FRAZIER SUCTION TUBE 10FG

21.600.60 FRAZIER SUCTION TUBE 12FG

21.870.10 ZOELLNER SUCTION TUBE

21.870.11 ZOELLNER SUCTION TUBE STILLETTE ONLY

21.870.35 ZOELLNER SUCTION TUBE END 20SWG

21.870.30 ZOELLNER SUCTION TUBE END 18SWG

21.870.40 ZOELLNER SUCTION TUBE END 22SWG

21.870.45 ZOELLNER SUCTION TUBE END 24SWG

21.870.50 ZOELLNER SUCTION TUBE END 26SWG

STAINLESS STEEL HOLLOWARE

89.350.20 KIDNEY DISH 6" (15.5CM)

89.350.40 KIDNEY DISH 8" (20CM)

89.350.60 KIDNEY DISH 10" (25.5CM)

89.350.80 KIDNEY DISH 12" (30.5CM)

89.353.20 KIDNEY DISH LID ONLY 6" (15.5CM)

89.353.40 KIDNEY DISH LID ONLY 8" (20CM)

89.353.60 KIDNEY DISH LID ONLY 10" (25.5CM)

89.353.80 KIDNEY DISH LID ONLY 12" (30.5CM)



89.375.10 LOTION BOWL 4" (10CM)

89.375.15 LOTION BOWL 5" (13CM)

89.375.20 LOTION BOWL 6" (15.5CM)

89.375.30 LOTION BOWL 8" (20CM)

89.375.40 LOTION BOWL 10" (25.5CM)

89.375.45 LOTION BOWL 12" (30.5CM)

89.378.20 LOTION BOWL LID ONLY 6" (15.5CM)