



GYNAECOLOGICAL AND OBSTETRIC INSTRUMENTS

TIMESCO
INSTRUMENTS FOR LIFE

TIMESCO GYNAECOLOGICAL AND OBSTETRIC INSTRUMENTS



In this publication we have only illustrated the 'popular' instruments, which are used today. Timesco's range encompasses many additional Gynaecological and Obstetric instruments, which are listed either in our price lists or in additional literature.

General instruments which are used in all surgical procedures are not listed in this publication but are available in our General Surgical instruments catalogue separately.

Traditionally, English manufactured instruments were all finished in mirror polish. We have now followed the convention in North America and in Europe and are producing all our instruments in Satin (Matt finish). This is a gradual process and is being applied to all new manufactured product once current stocks are depleted.

In Gynaecology and Obstetrics, some products have always been made in soft metals (eg. brass) and then plated, eg. dilators and lumened items such as catheters. These are also as an ongoing process being replaced once stocks are depleted by stainless steel.

The joints on items which may currently exist in screw joint are also being replenished with box joints. These improvements, upgrades will be automatically done.

For diameters/gauges charts such as MM, French gauge (FG), English gauge (EG) and comparison between, please refer to the back of this publication. Any conversion of measurements in inches or MM from gauges have been rounded to the nearest whole numbers.

Unless specifically listed otherwise, all products listed are stainless steel. S/P=Silver Plated, C/P=Chromium Plated.

For reprocessing and autoclaving, please refer to relevant Timesco data sheets.

The use, care and maintenance of products contained in this publication is limited to trained professionals only.

For Timesco's terms of trading, please refer to our price lists.

Orders can be placed by phone, fax, mail & email.

Please address all orders to:
Timesco Healthcare Ltd
Timesco House
3 Carnival Park,
Carnival Close,
Basildon, Essex,
SS14 3WN, England
Phone: + 44 (0) 1268 297 700
Fax: + 44 (0) 1268 297 800
Email: export@timesco.com



On all orders please state the invoice and delivery address together with your order number , quantity and description of the items required. For speedier processing of your orders, please specify Timesco catalogue numbers wherever appropriate.

Please specify any particular date you require the delivery of your goods, otherwise orders will be shipped within 10 to 12 weeks, unless urgently required by you.

All orders are confirmed by email / fax by us on receipt. If you do not receive our confirmation within 2 days of sending your order to us, please contact us.

All prices are quoted ex works, unless otherwise stated. All prices are per single unit, that is, 1, unless a packet quantity is specified.

All goods are shipped by UPS courier , unless the weight / volume justifies a shipment by alternative means.

CERTIFICATES & APPROVALS

Timesco Healthcare Ltd. are registered, approved, hold licences or are authorised by organisation as listed below:

- 1) ISO 13485 / ISO 9001: 2000
- 2) CE 0120 (Class II)
- 3) FDA Manufacturers License (USA)
(Registration Number: 8021788)
- 4) SFDA CHINA
- 5) SFDA SAUDI ARABIA
- 6) PRODUCTS REGISTERED IN FOLLOWING COUNTRIES:
U.S.A., CANADA, MEXICO, CHINA, SAUDI ARABIA.



CE
0120



Classification

Unless specified otherwise, TIMESCO products are classified under the harmonised tariff: 90-1890-8400. Instruments medical and surgical/appliances/dental/veterinary.

For certificates please visit our website www.timesco.com

TIMESCO GUARANTEE

The respective guarantee will be the number of years or the number of autoclave cycles, whichever is sooner and is from the date of purchase. Autoclave cycles are approved to 134 °C for 3 minutes holding time or 134°C for 18 minutes holding time.

If any of Timesco's reusable products crack, bend, deform, corrode or fail whilst being used for the intended purpose within the guarantee period, we will repair it or replace it free of charge.

Reusable Surgical Instruments:

Range	Guarantee	No. of Autoclave Cycles
Reusable surgical instruments (excluding the sections of the products listed below)	5 years	4,000
• The cutting, shearing, grinding and rasping edges (excluding Tungsten Carbide)	1 year	800
• The cutting, shearing, grinding and rasping edges (Tungsten Carbide)	2 years	1,600

BRANDING & LOT NUMBERING



Timesco products carry serial / LOT numbers on the packaging and on the products themselves to aid traceability.

SCISSORS- UMBILICAL CORD

BUSCH _____	7
AMERICAN _____	7

SCISSORS - UTERINE

DUBOIS _____	8
FERGUSSON _____	8
SIMS _____	9
UTERINE _____	9

SCISSORS - EPISIOTOMY

LAWSON TAIT _____	10
STADLER BRAUN _____	10

RETRACTORS

COMYN BERKELEY _____	11
DOYEN _____	11
DOYEN POZZI _____	12
GELPI _____	12
DOYEN (VAGINAL) _____	13
JOLL _____	13
LANDON _____	14
WERTHEIM _____	14

HORMONE TROCARS

TROCAR SETS _____	15
-------------------	----

CATHETERS

FEMALE _____	15
ROTUNDA _____	15

NEEDLE EXTENSIONS

TIMESCO _____	16
---------------	----

BLADDER SOUNDS

FEMALE _____	16
--------------	----

VAGINAL CLAMPS

FEMALE _____	16
--------------	----

DRESSING FORCEPS

BOZEMAN _____	17
VAGINAL _____	17

SPECULUMS

AUVARD _____	18
COLLIN _____	19
CUSCO _____	20
CUSCO (SIDE SCREW) _____	21
GRAVES _____	22
GRAVES (WIDE) _____	23
WEISMAN GRAVES _____	24-25
PEDERSON _____	26
SIMS (SINGLE ENDED) _____	27
SIMS (DOUBLE ENDED) _____	28-29
WINTERTON _____	30

LATERAL WALL RETRACTORS

TIMESCO (VAGINAL) _____	31-32
-------------------------	-------

BIOPSY FORCEPS

BURKE _____	33
EPPENDORF _____	33
FAURE _____	34
KEVORKIAN YOUNG _____	34
LEECH WILKINSON _____	34
SCHUBERT _____	35
SCHUMACHER _____	35-36
TISCHLER _____	36-37
VAN DORAN _____	37
WITTNER _____	37

DILATORS

BONNEY - BARKER _____	38
HANK _____	38
HAWKIN AMBLER _____	39
HEGAR _____	39-40
PRATT _____	40

ENDOCERVICAL SPECULUMS

KOGAN _____	41
-------------	----

TENACULUM / VULSELLUM FORCEPS

ATRAUMA _____	41
TIMESCO ATRAUMA _____	41

BIERER _____	42
BRAUN _____	42
DUPLAY _____	42
LEWER _____	43
LUER _____	43
TIMESCO LUER _____	43
ROTUNDA _____	44
SCHROEDER _____	44
TEAL _____	44

ENDOCERVICAL CURETTES

KEVORKIAN _____	45
-----------------	----

UTERINE CURETTES

RECAIMER _____	46-49
SIMS (SINGLE ENDED) _____	50
SIMS (DOUBLE ENDED) _____	50

FLUSHING CURETTES

RHEINSTADTER _____	51
--------------------	----

BIOPSY CURETTES

LEECH WILKINSON _____	51
NOVAK _____	52
RANDALL _____	52
SHARMAN _____	52

Continued Overleaf...

CONTENTS

DEEPRESSORS

BRAUN	53
SIMS	53

UTERUS HOLDING FORCEPS

COLLIN	54
DARTIGUE	54
SOMER	54

HYSTERECTOMY CLAMPS

BONNEY	55
BONNEY - BERKLEY	55
GWILLIAM	55
HEANEY	56
HUNTER	56
MAINGOT	56
MCCULLAGH	57
NAVRATILL	57
WERTHEIM	57
TIMESCO PARAMETRIUM	58

INSUFFLATION CANNULAS

CURRIE	58
HAYES - PROVIS	58
LEECH WILKINSON	59
PROVIS	59
SPACKMAN	59

MYOMA SCREWS

DOYEN MYOMA	60
-------------	----

MYOMECTOMY CLAMPS

BONNEY	60
--------	----

POLYPUS FORCEPS

BONNEY POLYPUS	61
KELLY POLYPUS	61
TIMESCO POLYPUS	61

UTERINE SOUNDS

GALABIN	62
HORROCK	62
SIMPSON	62
SIMS	63

IUCD UTERINE HOOKS

GRAFENBERG	63
------------	----

IUCD REMOVAL FORCEPS

TIMESCO	63
---------	----

CAESAREAN SECTION FORCEPS

GREEN - ARMYTAGE	64
------------------	----

INDUCTION CATHETERS

DREW SMYTHE	64
-------------	----

CRANIO AND CEPHALO

BRAUN	65
WINTER	65

UTERUS EVACUATION / ASPIRATION CURETTES

BIERER	65
--------	----

INDUCTION FORCEPS

GOODWIN	66
---------	----

OBSTETRIC FORCEPS

ANDERSON	66
BARNES NEVILLE	66
DE LEE	67
HAIG FERGUSON	67
KIELLAND	67
KIELLAND LUIKART	67
MILNE MURRAY	68
SIMPSON	68
TARNIER	68
WRIGLEY	68

MUCOUS EVACUATORS

CARTON	69
--------	----

OVUM / PLACENTA FORCEPS

BIERER	69
GREENHALGH	69
HEYWOOD SMITH	70
MCLINTOCK	70
WILLETT	70

PELVIMETERS

BREISKY	71
MARTIN	71

PERFORATORS

DENMAN	72
SIMPSON	72

UMBILICAL DILATORS	72
--------------------	----

STETHOSCOPES

PINARD	72
--------	----

SCISSORS - UMBILICAL CORD



12.230.25 BUSCH UMBILICAL CORD STRAIGHT 5" (13CM)

12.230.50 BUSCH UMBILICAL CORD CURVED TO SIDE 5" (13CM)

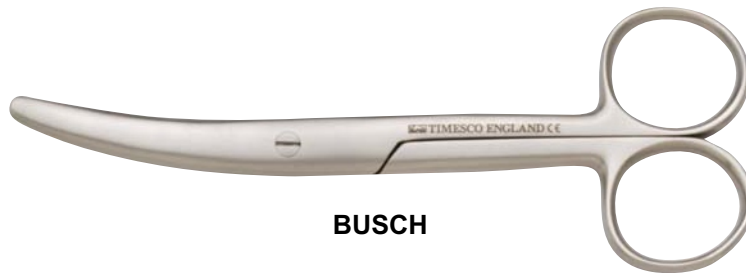

BUSCH

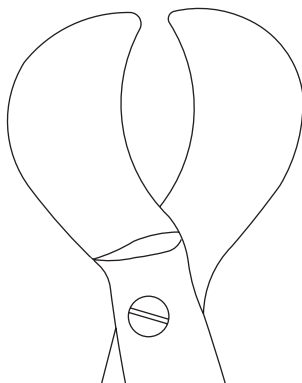

12.690.25 UMBILICAL CORD AMERICAN 4.25" (10.5CM)



AMERICAN

Timesco Umbilical Cord scissors, like all Timesco scissors feature super sharp cutting edges, which allow ease in cutting and minimal finger fatigue.

By far the most popular Umbilical Cord scissors are the 'American' pattern. This scissors feature 'parrot faced' curved inwards concave cutting edges which prevent the cord from slipping during shearing.

SCISSORS - UTERINE

Timesco Uterine scissors are powerful cutting instruments all of which feature strong shanks and thick blades, which can incise thick muscular tissue with ease in Gynaecological and Obstetric procedures.

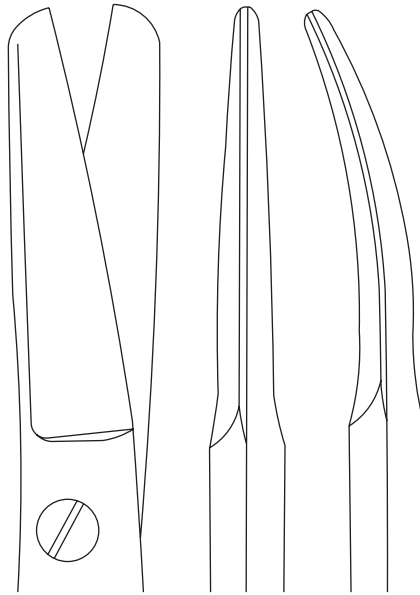

12.360.25 DUBOIS STRAIGHT 10.5" (27CM)

12.360.50 DUBOIS CURVED 10.5" (27CM)



DUBOIS

All Timesco cutting instruments are made from especially hardened and tempered steel to provide durable performance.

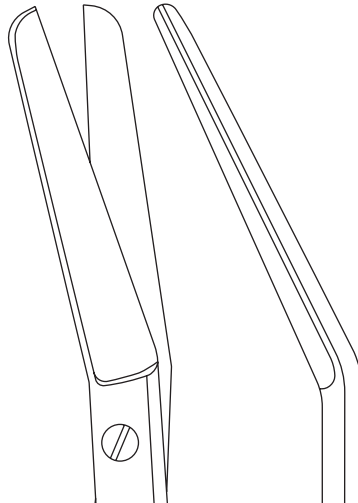

12.395.10 FERGUSSON UTERINE ANGLED 6.5" (16.5CM)

12.395.20 FERGUSSON UTERINE ANGLED 7" (18CM)

12.395.30 FERGUSSON UTERINE ANGLED 8.25" (21CM)



FERGUSSON

SCISSORS - UTERINE

Uterine scissors are also available in Tungsten Carbide cutting edges, please see separate catalogue.



12.640.25 SIMS UTERINE STRAIGHT 9" (23CM) BLUNT / BLUNT

12.640.50 SIMS UTERINE CURVED 9" (23CM) BLUNT / BLUNT



SIMS

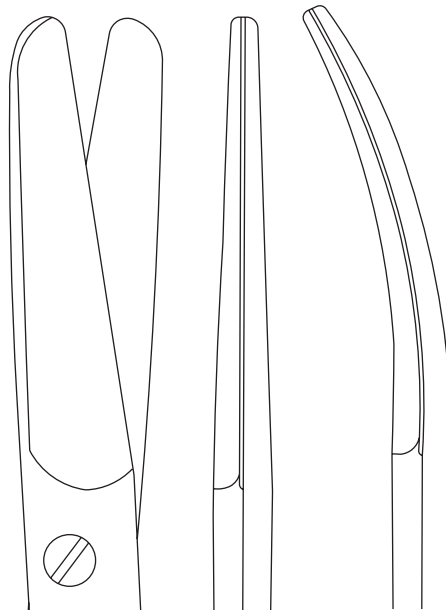

12.700.10 UTERINE STRAIGHT 9" (23CM) BLUNT / BLUNT

12.700.20 UTERINE Curved 9" (23CM) BLUNT / BLUNT



UTERINE

SCISSORS - EPISIOTOMY

Timesco Episiotomy scissors feature thick strong and powerful blades for efficient clean shearing in Episiotomy procedures.

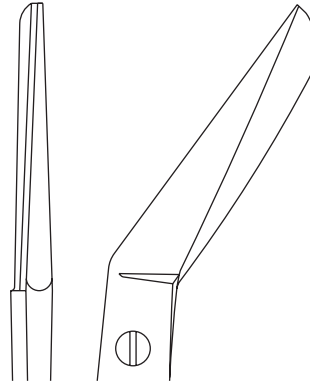

12.475.25 LAWSON TAIT EPISIOTOMY 5.5" (14CM)



LAWSON TAIT

Episiotomy scissors feature angled blades to allow easier access to the perinium. The peculiarly offset ringed 'Lawson Tait' scissors are also known as 'Barnes'.

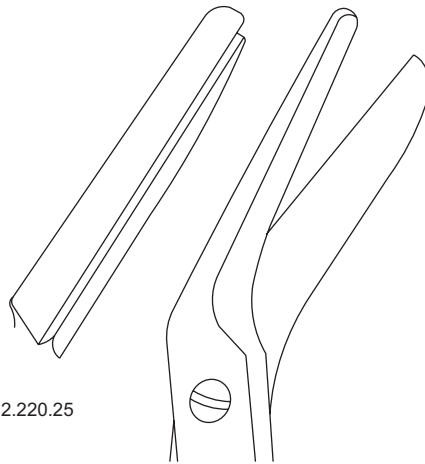

12.220.25

12.220.25 BRAUN STADLER EPISIOTOMY 5.5" (14CM)

12.220.50 BRAUN STADLER EPISIOTOMY 8.75" (22CM)

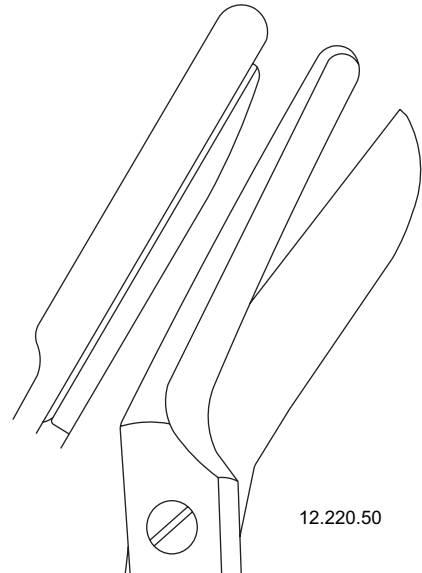

12.220.50

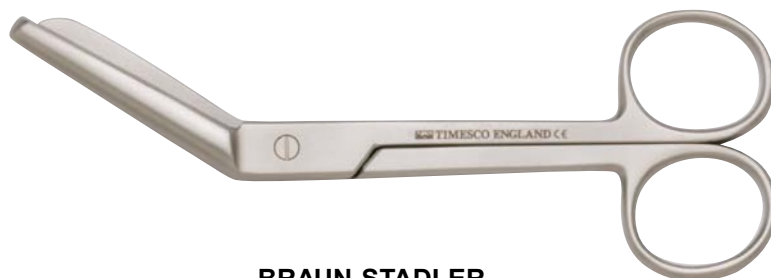

BRAUN STADLER

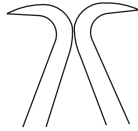

15.160.10 COMYN BERKELEY VULVA SELF RETAINING 6" (15.5CM)



COMYN BERKELEY

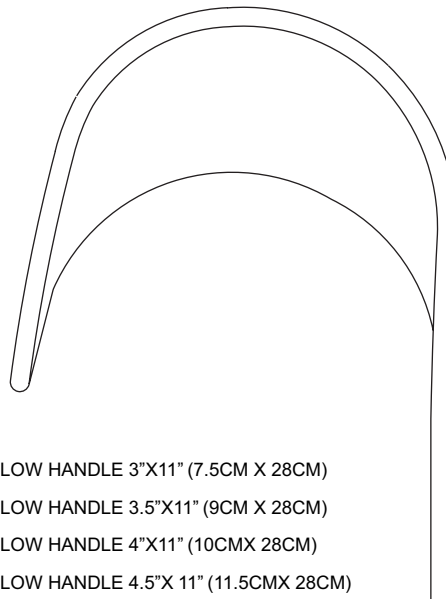

- 15.215.10 DOYEN SUPRA HOLLOW HANDLE 3"X11" (7.5CM X 28CM)
- 15.215.20 DOYEN SUPRA HOLLOW HANDLE 3.5"X11" (9CM X 28CM)
- 15.215.30 DOYEN SUPRA HOLLOW HANDLE 4"X11" (10CMX 28CM)
- 15.215.40 DOYEN SUPRA HOLLOW HANDLE 4.5"X 11" (11.5CMX 28CM)

The Doyen retractors in particular are very practical and useful instruments in procedures for caesarean sections and abdominal wall retraction in myomectomies / hysterectomies etc.

The large curved edges on the sides of the blades retract the abdominal wall very effectively allowing maximum exposure.



DOYEN

RETRACTORS

Many varieties of 'general retractors' are used not only in vaginal but abdominal Gynaecological and Obstetric procedures, we have only listed some popular designs in this catalogue.

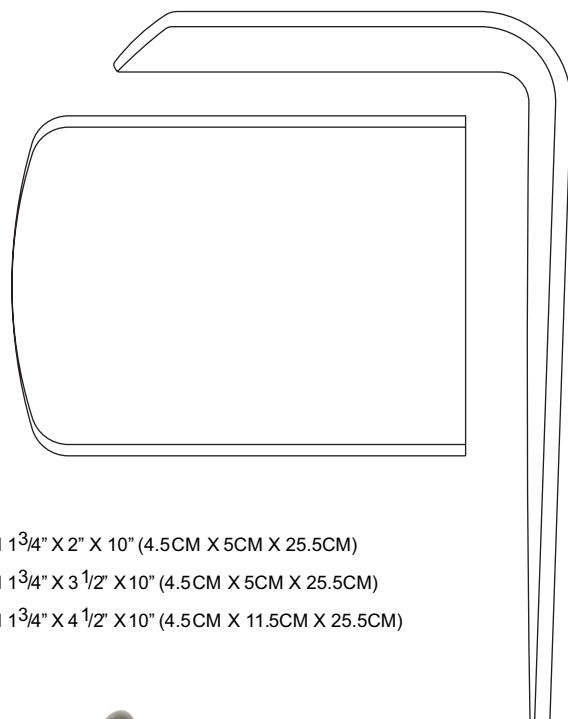

- 15.235.10 DOYEN POZZI 1³/₄" X 2" X 10" (4.5CM X 5CM X 25.5CM)
- 15.235.20 DOYEN POZZI 1³/₄" X 3 1/2" X 10" (4.5CM X 5CM X 25.5CM)
- 15.235.30 DOYEN POZZI 1³/₄" X 4 1/2" X 10" (4.5CM X 11.5CM X 25.5CM)

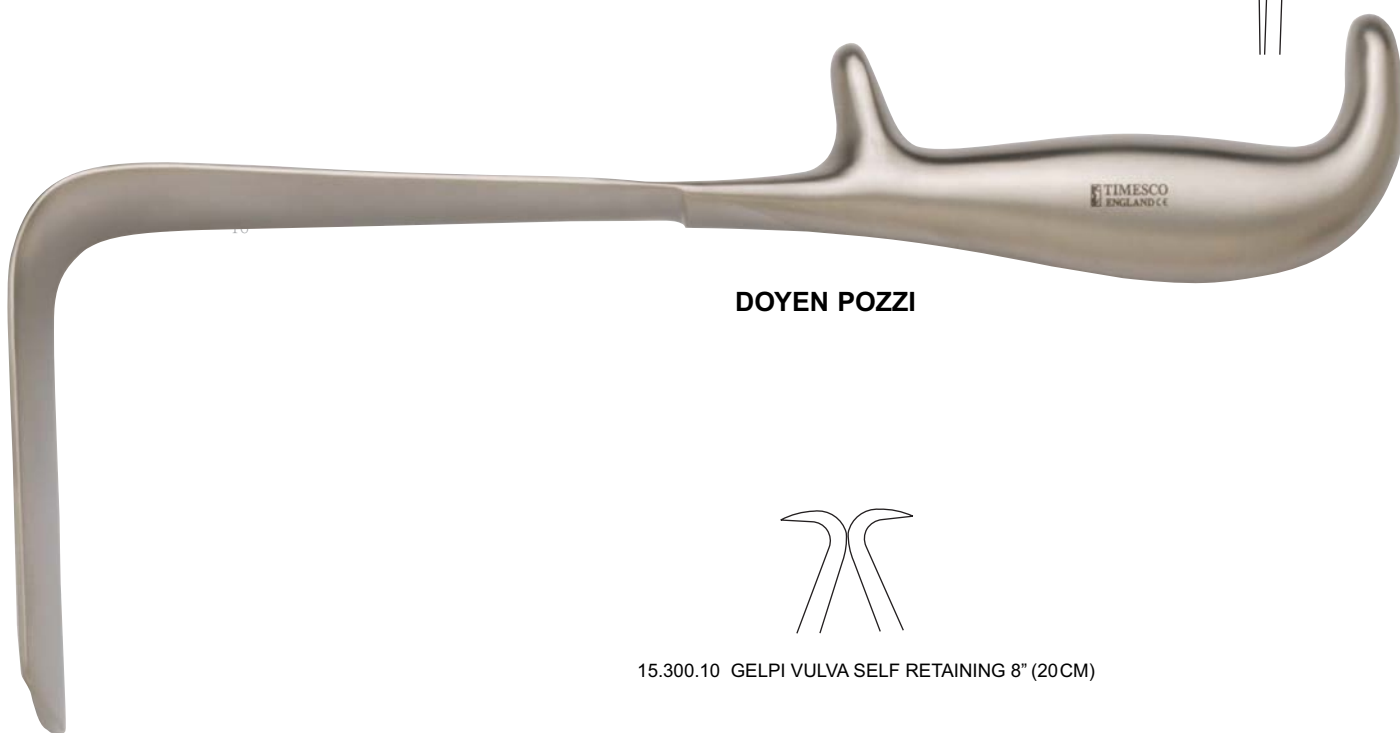

DOYEN POZZI



15.300.10 GELPI VULVA SELF RETAINING 8" (20CM)

Vulva retractors, such as Gelpi, Blair and Joll (Thyroid) feature sharp pin jaws which affix to the vulva walls, allowing unaided retraction and minimum trauma.



GELPI

DOYEN

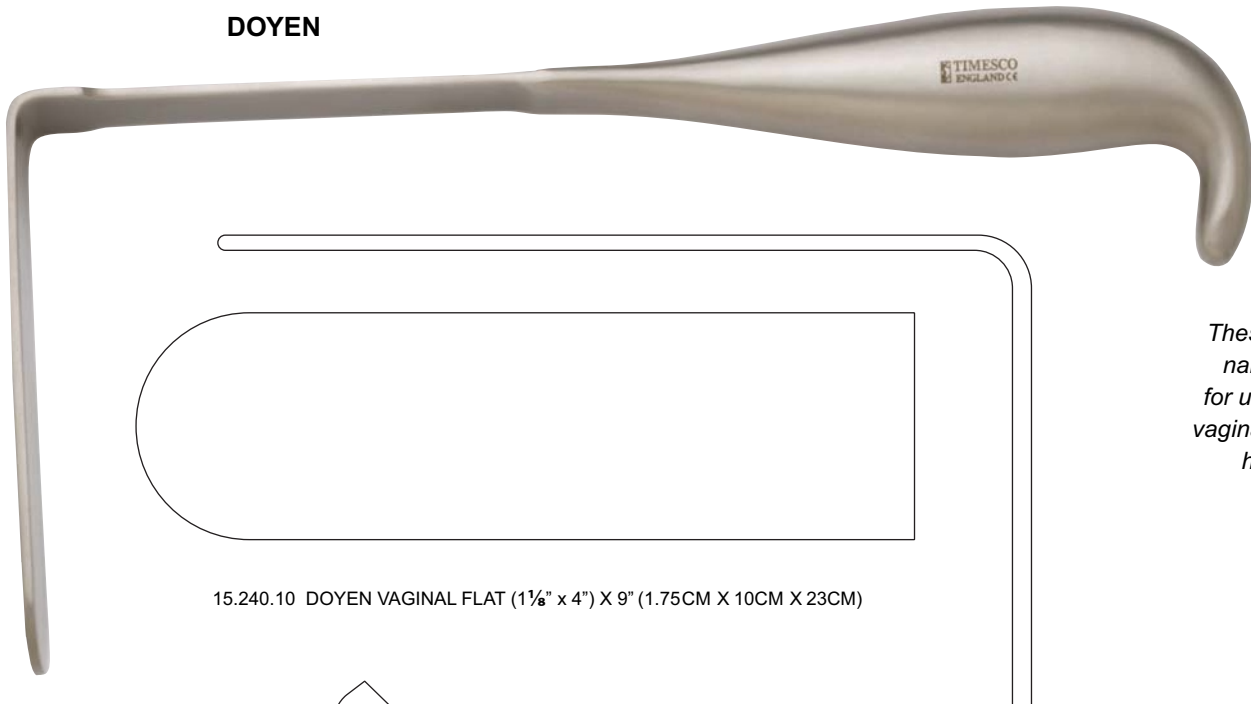

15.240.10 DOYEN VAGINAL FLAT (1 1/8" x 4") X 9" (1.75CM X 10CM X 23CM)

These feature long narrow blades, for use through the vaginal walls and are hand held.

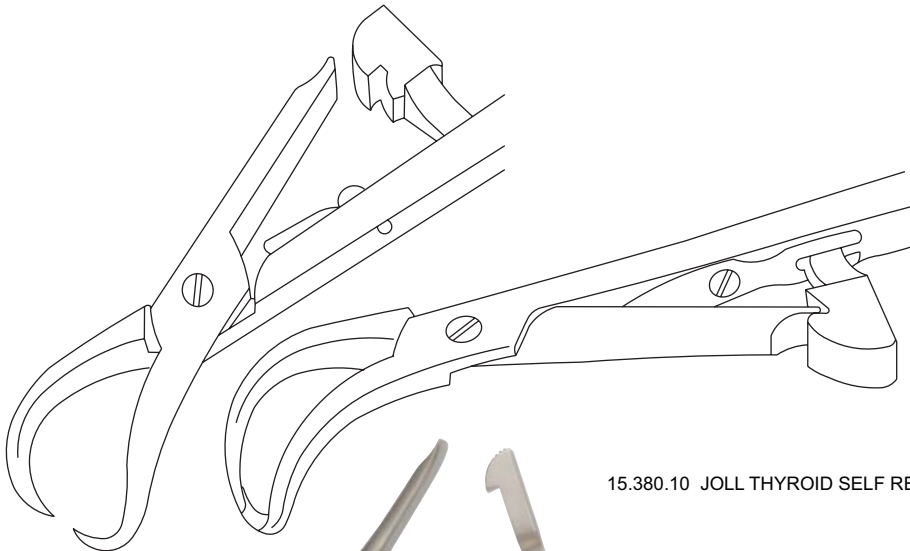

15.380.10 JOLL THYROID SELF RETAINING 6" (15.5CM)

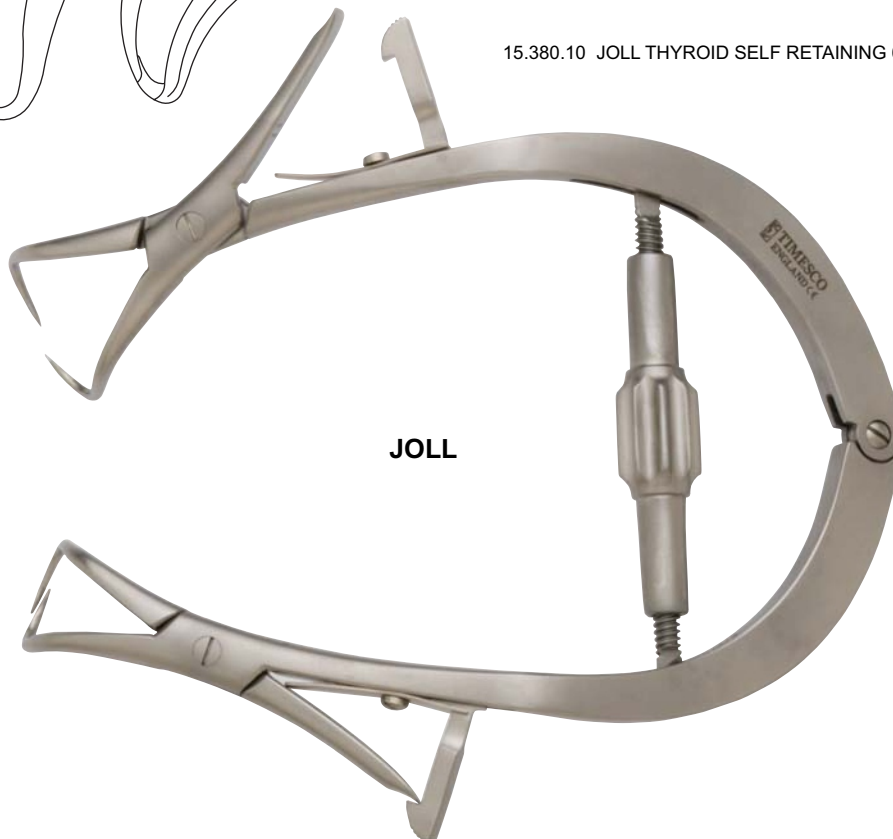

JOLL

The complete retractor range is available in our 'general surgical' sections.

RETRACTORS

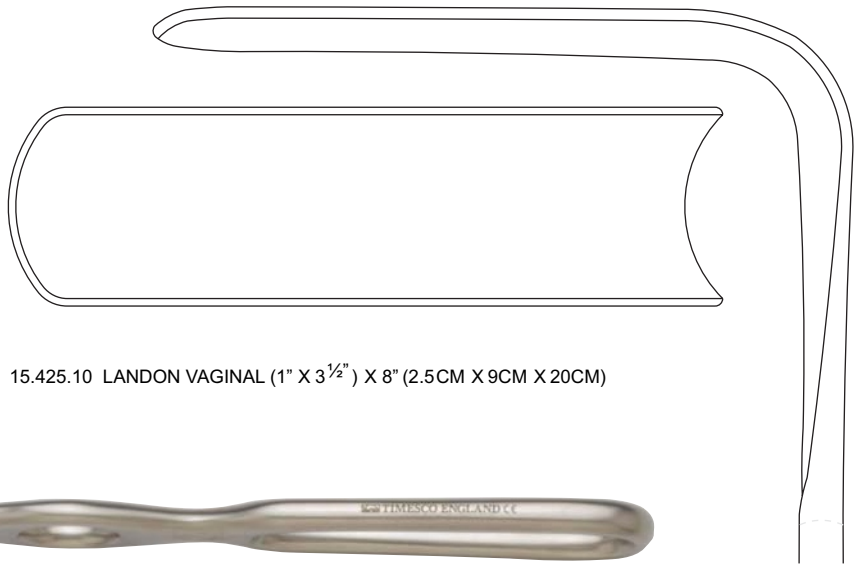

15.425.10 LANDON VAGINAL (1" X 3 1/2") X 8" (2.5CM X 9CM X 20CM)

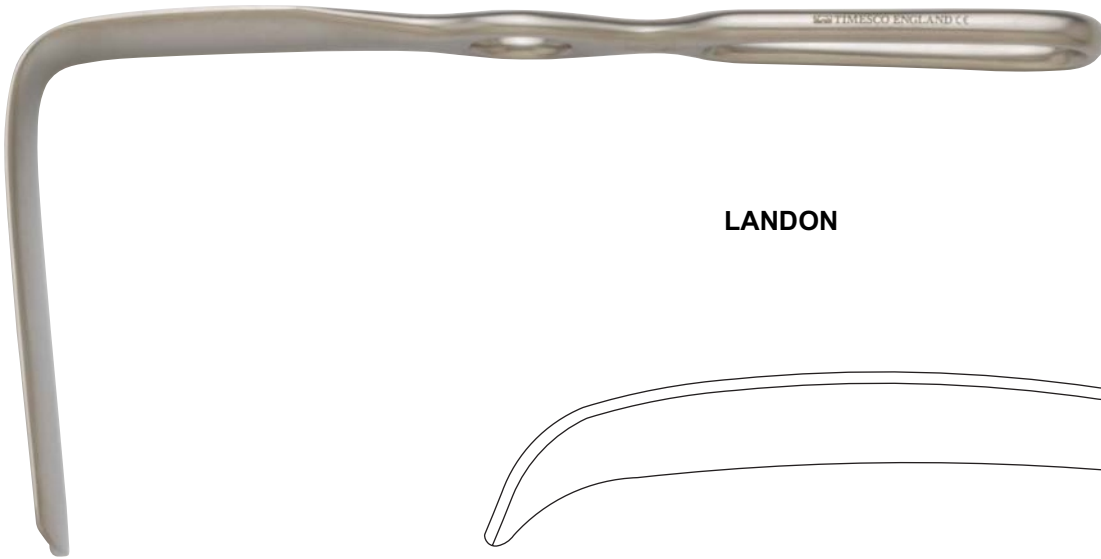

LANDON

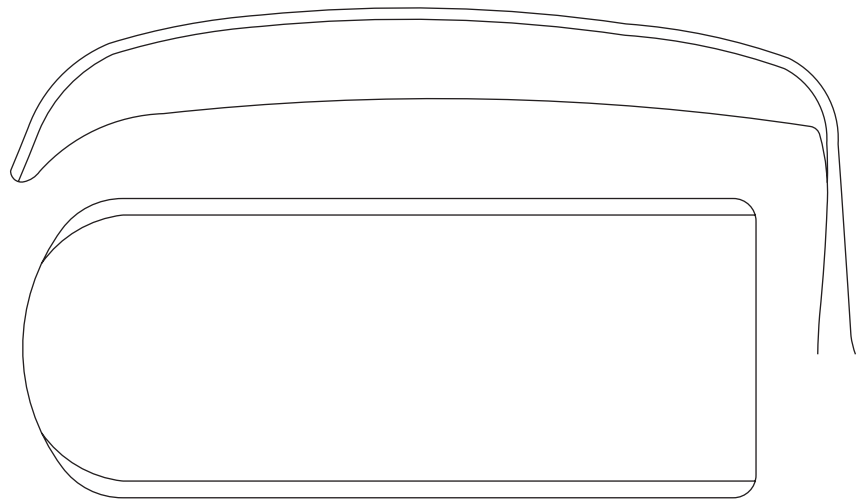

Wertheim retractors are also known as 'Breisky' and 'Vienna' patterns.

WERTHEIM

15.670.10 WERTHEIM (1 1/2" X 3 3/4" X 10 3/4" (3CM X 9.5CM X 27.5CM)

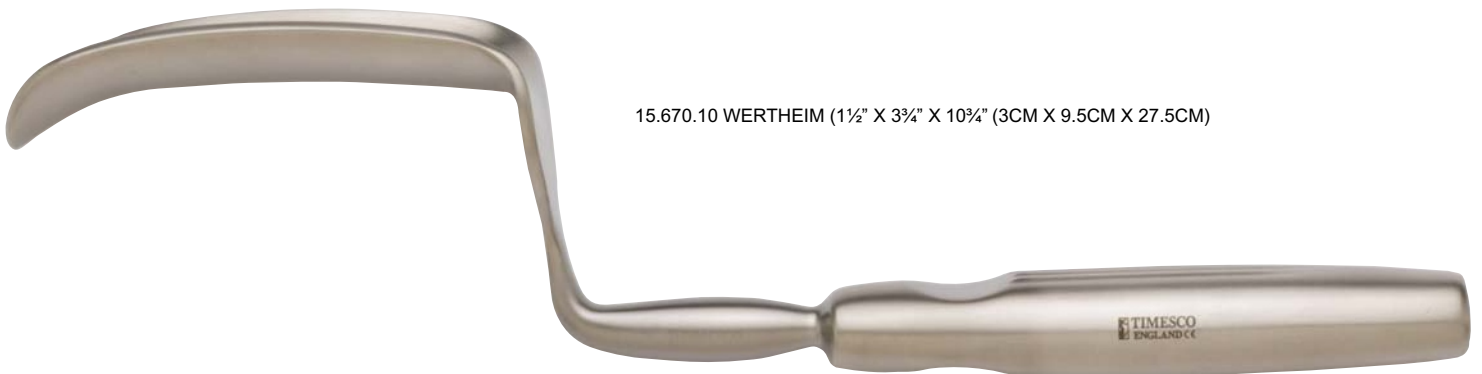

HORMONE TROCARS

○ 5mm



- 21.250.10 HORMONE IMPLANT TROCAR SET 5MM X 25MM CANNULA, 4.5" (11.5CM)
- 21.250.20 HORMONE IMPLANT TROCAR SET 5MM X 50MM CANNULA, 5.5" (14CM)
- 21.250.30 HORMONE IMPLANT TROCAR SET 5MM X 80MM CANNULA, 6.75" (17CM)

For H.R.T. (hormone replacement treatment), hormone pellets are introduced under the skin to introduce progesterone, testosterone and oestradiol. Timesco manufactures three of the most popular sizes, each supplied complete with pellet introducing rods.

CATHETERS

FEMALE



- 6EG 4mm
- 7EG 4.5mm
- 8EG 5mm
- 9EG 5.5mm
- 10EG 6mm

- 57.100.10 FEMALE 6" (15.5CM) 6EG S/P
- 57.100.20 FEMALE 6" (15.5CM) 7EG S/P
- 57.100.30 FEMALE 6" (15.5CM) 8EG S/P
- 57.100.40 FEMALE 6" (15.5CM) 9EG S/P
- 57.100.50 FEMALE 6" (15.5CM) 10EG S/P

The traditional 'female' and 'Rotunda' catheters for evacuation of the bladder are still available from Timesco despite many of these applications having been transferred to disposable plastic.

ROTUNDA



- 8EG 5mm
- 10EG 6mm

- 57.120.10 ROTUNDA FEMALE 7.5" (19CM) 8EG S/P
- 57.120.20 ROTUNDA FEMALE 7.5" (19CM) 10EG S/p

The catheters are made from toughened tube and then electroplated with silver. Stilletes for cleaning are supplied with all Timesco catheters.

NEEDLE EXTENSIONS

The size of the injection needles is often not long enough to inject the Para cervical or vaginal tissue in some procedures. Timesco produces three sizes of needle extensions, which can be used on the syringe to extend the working length of the needle. Needle extensions have luer lock fittings.



- 57.125.10 TIMESCO 3" (7.5CM) LEUR
- 57.125.20 TIMESCO 4" (10CM) LEUR
- 57.125.30 TIMESCO 5" (13CM) LEUR

BLADDER SOUNDS

We are illustrating these, but these are now rarely used.

The word 'sound' is a misnomer – it is a relic from the early days of surgery when a Bougie was said to have made a 'sound' when it made contact with stones in the bladder! etc.



- 6EG 4mm
- 8EG 5mm
- 10EG 6mm
- 12EG 7mm

- 57.130.20 FEMALE 6EG 9½" (24CM)
- 57.130.30 FEMALE 8EG 9½" (24CM)
- 57.130.40 FEMALE 10EG 9½" (24CM)
- 57.130.50 FEMALE 12EG 9½" (24CM)

VAGINAL CLAMPS



57.150.20 BONNEY 13.5" (34.5CM) SCREW JOINT

There are two 'Bonney' clamps, which are used for uterine applications. These forceps feature powerful clamping action, double finger rings and strong interlocking positive ratchets. This clamp was originally made for the classic 'Wertheim's operation'.

DRESSING FORCEPS

These forceps are available in a variety of jaw configurations and their principal use is in 'packing' (swab/gauge) in Gynaecological procedures. The Bozeman forceps are multipurpose instruments and are also used for holding/introducing catheters/drains etc.

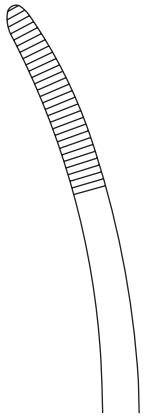

57.170.20

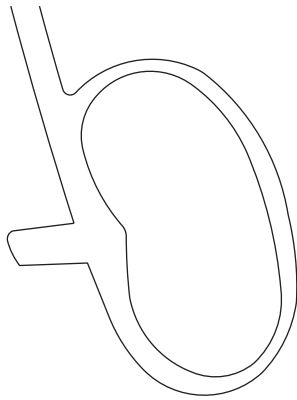

57.170.30

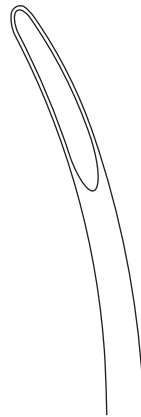

57.170.40

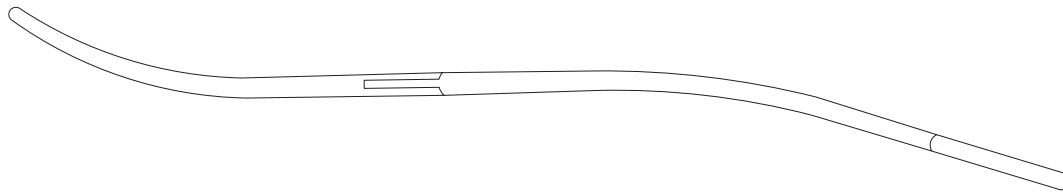

57.170.20 BOZEMAN SERRATED 10.5" (27CM) BOX JOINT

57.170.30 BOZEMAN LARGE BOW SERRATED 10.5" (27CM) BOX JOINT

57.170.40 BOZEMAN GROOVED 10.5" (27CM) BOX JOINT



BOZEMAN

57.190.20 VAGINAL 9.5" (24CM) SERRATED



SPECULUMS

From the simple retractor type 'Sims' speculum to the bivalve Cusco, Graves etc., Timesco manufacture an extensive range of speculums. Speculums are basic vaginal retractors, and open the vagina for exposure of the cervix etc.

If speculum sizes have been stated they are width x length.

- 57.235.20 AUVARD SMALL FIXED WEIGHT 38MM X 75MM
- 57.235.40 AUVARD LARGE FIXED WEIGHT 38MM X 105MM
- 57.235.60 AUVARD SMALL LOOSE WEIGHT 38MM X 75MM
- 57.235.80 AUVARD LARGE LOOSE WEIGHT 38MM X 105MM

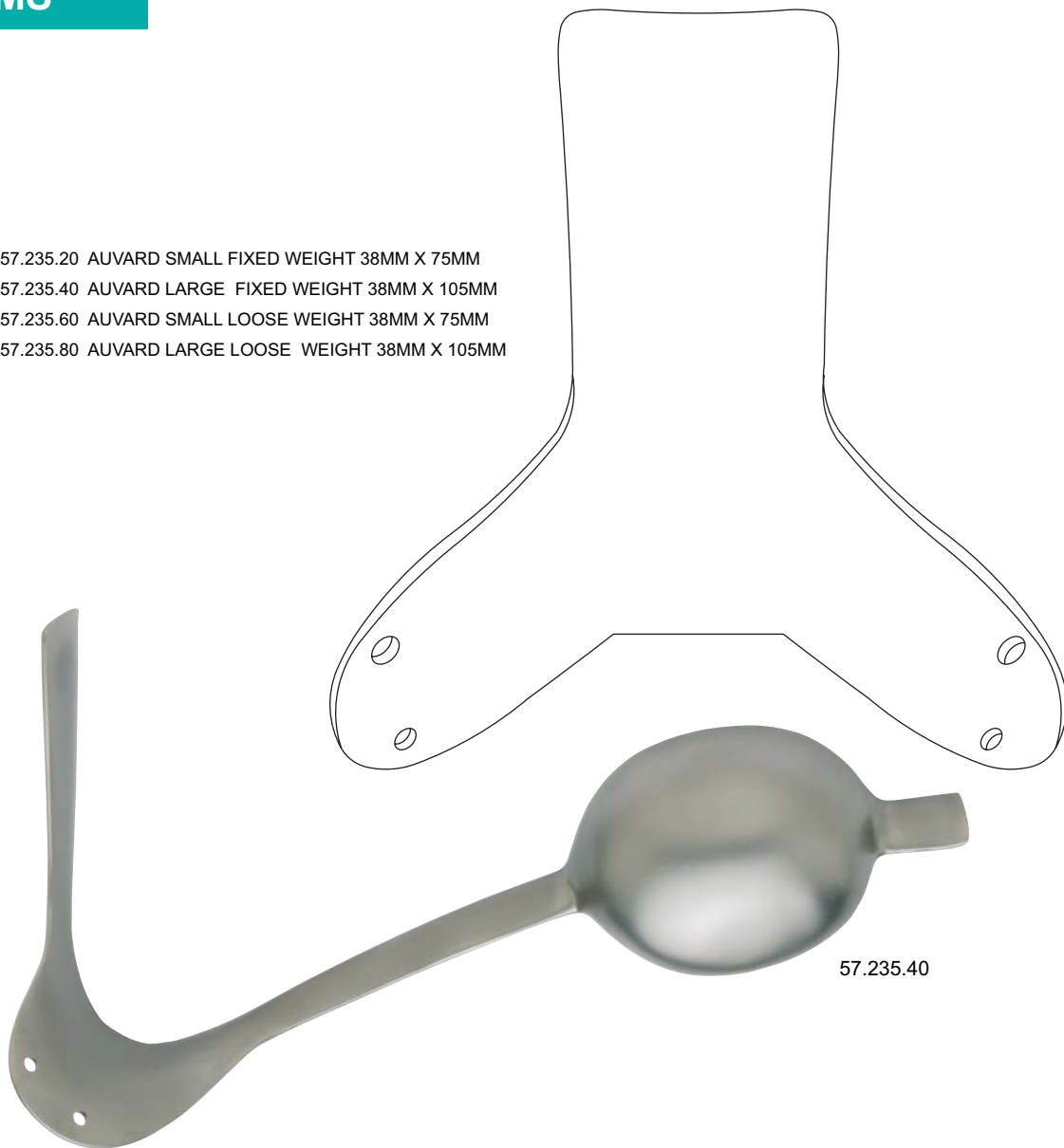

9

Wherever outline drawings of speculum blade sizes and rear profiles are given, for illustrative purposes, a 'medium' speculum size is used wherever available.



AUVARD

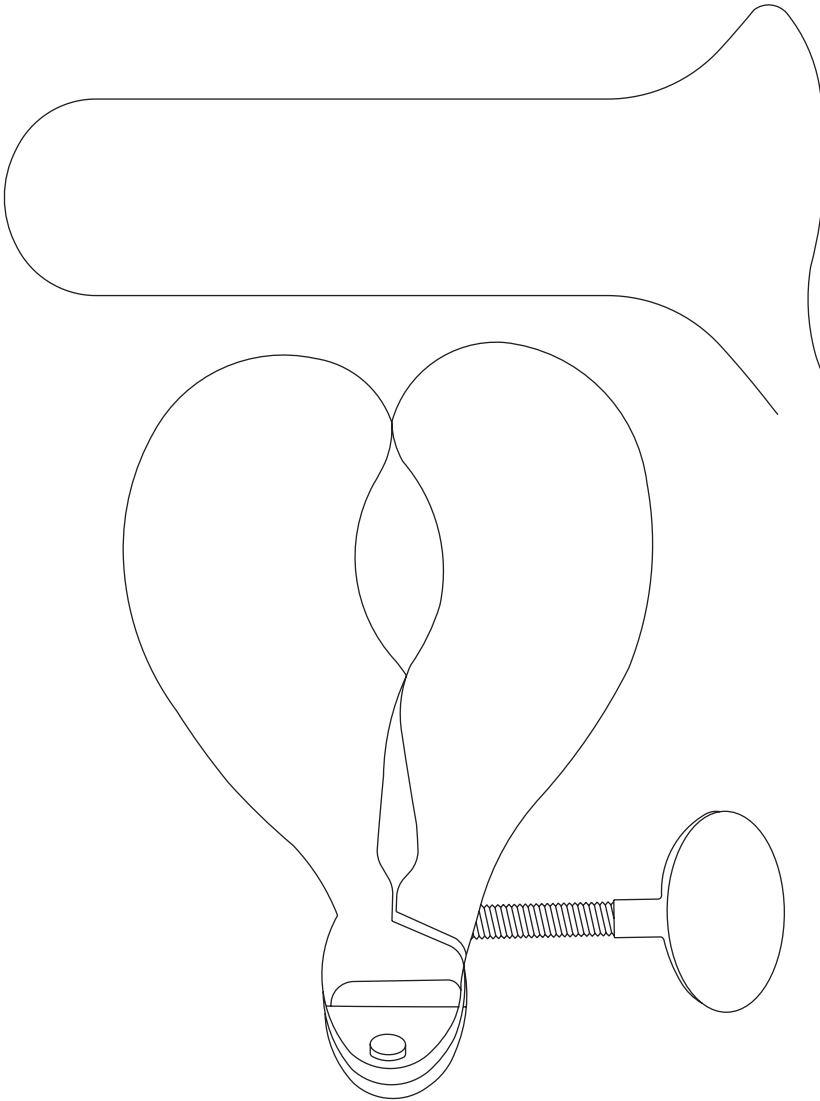

Speculums vary in size and pattern but function is the same. Some speculums, eg. Auvards, also feature 'weighted' handles, which allow unaided retraction.

- 57.280.20 COLLIN SMALL 30MM X 85MM
- 57.280.40 COLLIN MEDIUM 35MM X 100MM
- 57.280.60 COLLIN LARGE 40MM X 110MM



COLLIN

SPECULUMS

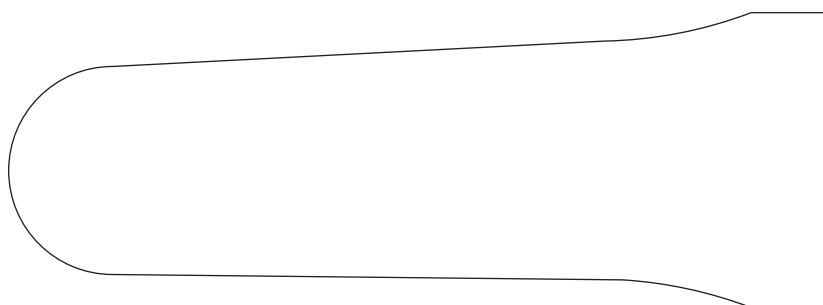

Timesco offer both versions of the classic speculum: Cusco, these are available in the traditional British through the handle screw lock arrangement and the Continental 'side screw' pattern.

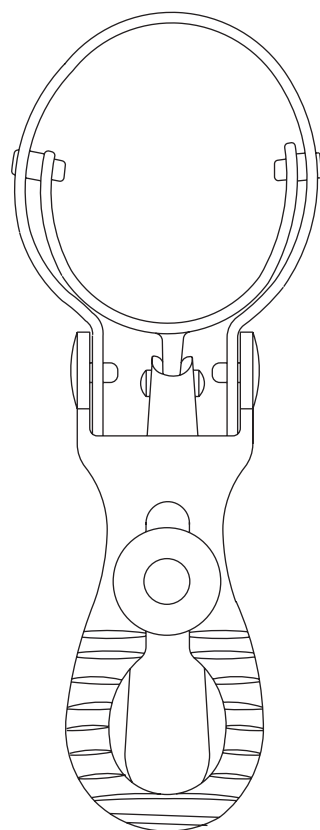

- 57.295.10 CUSCO VIRGIN 15MM X 65MM
- 57.295.13 CUSCO VIRGIN LONG 15MM X 85MM
- 57.295.15 CUSCO SMALL 25MM X 80MM
- 57.295.20 CUSCO MEDIUM 30MM X 90MM
- 57.295.25 CUSCO MEDIUM LONG 30MM X 115MM
- 57.295.30 CUSCO LARGE 35MM X 95MM

All Timesco speculums are now manufactured in stainless steel only.

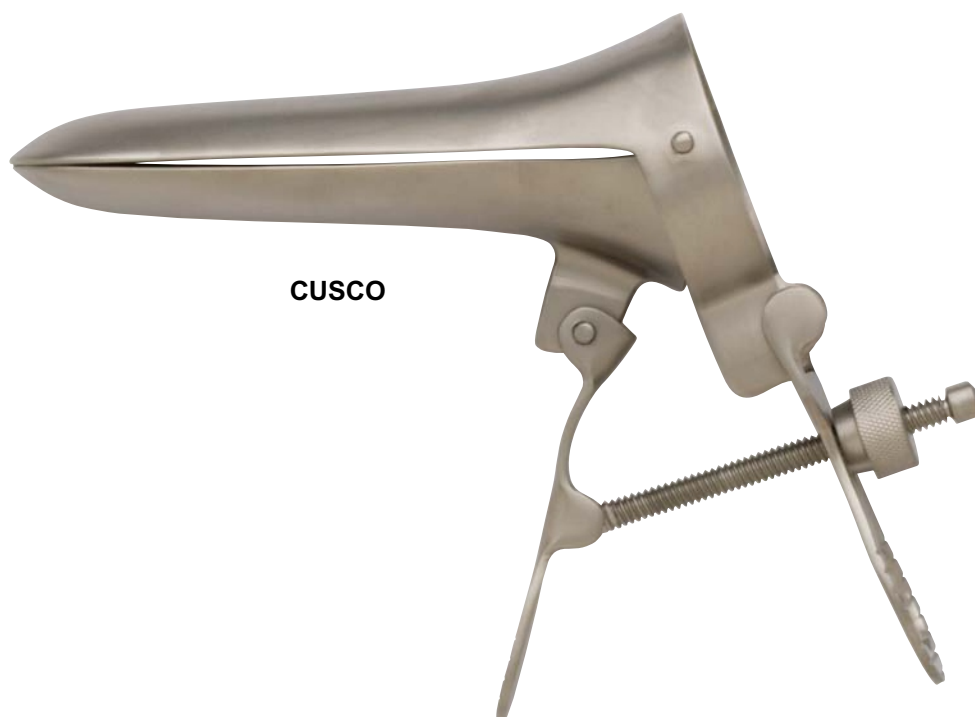

CUSCO

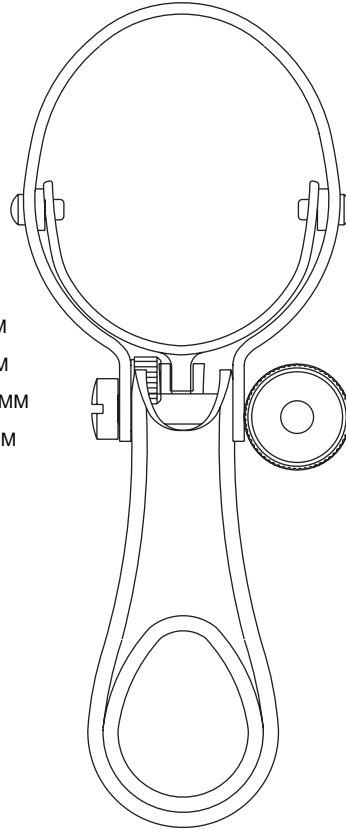
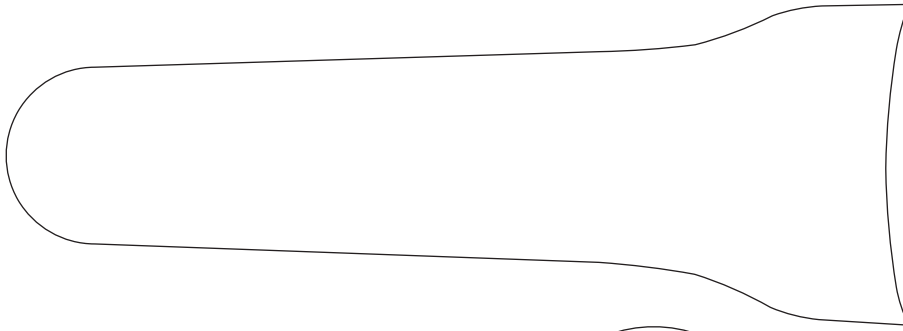

- 57.300.20 CUSCO VIRGIN SIDE SCREW 17MM X 75MM
- 57.300.30 CUSCO SMALL SIDE SCREW 22MM X 80MM
- 57.300.40 CUSCO MEDIUM SIDE SCREW 25MM X 100MM
- 57.300.50 CUSCO LARGE SIDE SCREW 27MM X 105MM

*This side screw
Cusco patterns are
also referred to
as 'Swiss pattern'.*



CUSCO

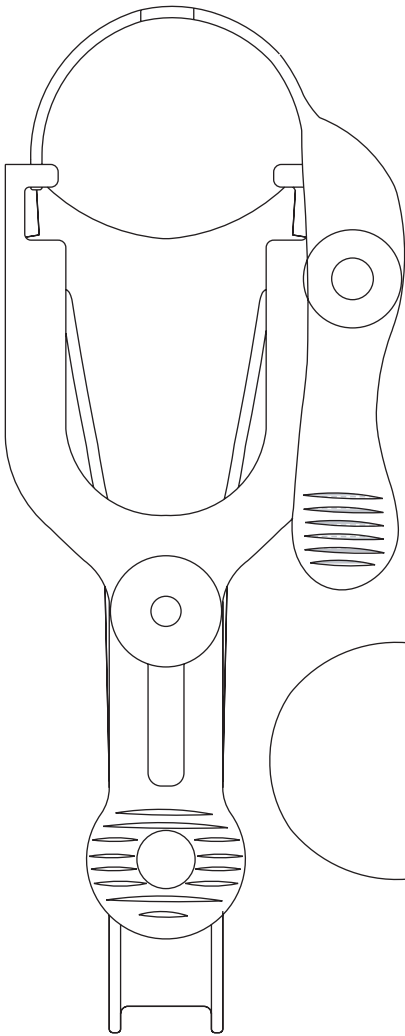

- 57.400.20 GRAVES (BREWER) SMALL 20MM X 75MM
- 57.400.30 GRAVES (BREWER) MEDIUM 35MM X 95MM
- 57.400.40 GRAVES (BREWER) LARGE 35MM X 115MM

Both the Graves and Pederson speculums can be unscrewed from the screw in their handles and the upper blades raised vertically.

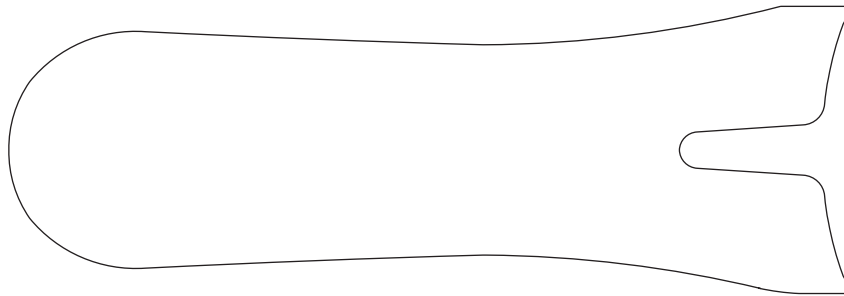

The speculum can also be used as single ended speculums, such as the Sims, by unscrewing the central screw and rotating one section 180°, for retrograde procedures.



GRAVES



Graves 'Wide' pattern speculums have a larger opening at the back of the speculums allowing larger exposure and ease of insertion of instruments such as the standard and 3" opening Timesco lateral wall retractors.

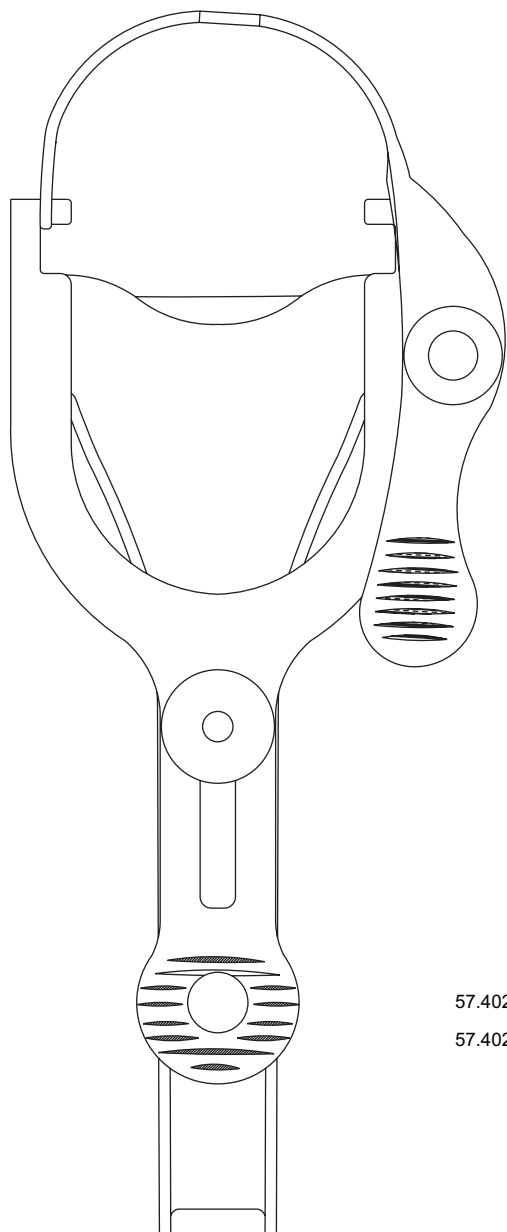

GRAVES WIDE

57.402.30 GRAVES MEDIUM WIDE PATTERN 33MM X 105MM

57.402.40 GRAVES LARGE WIDE PATTERN 34MM X 115MM

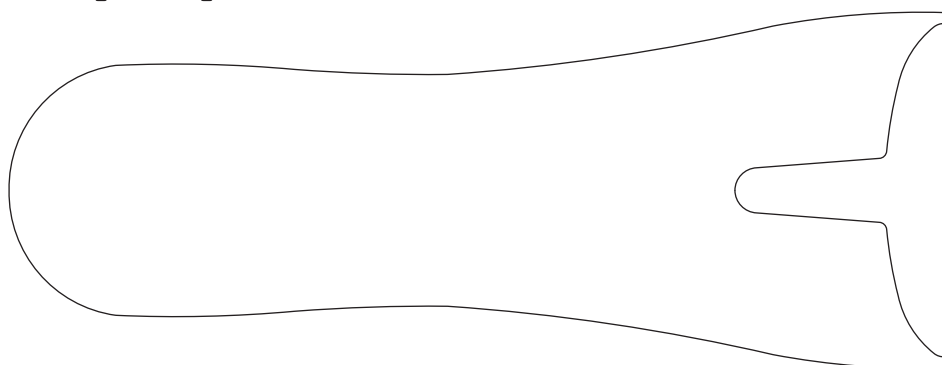

SPECULUMS

Part of the sides of the upper blades in the left and right opening Weisman Graves speculums have been removed to allow greater visualisation of the left and right vaginal walls respectively.

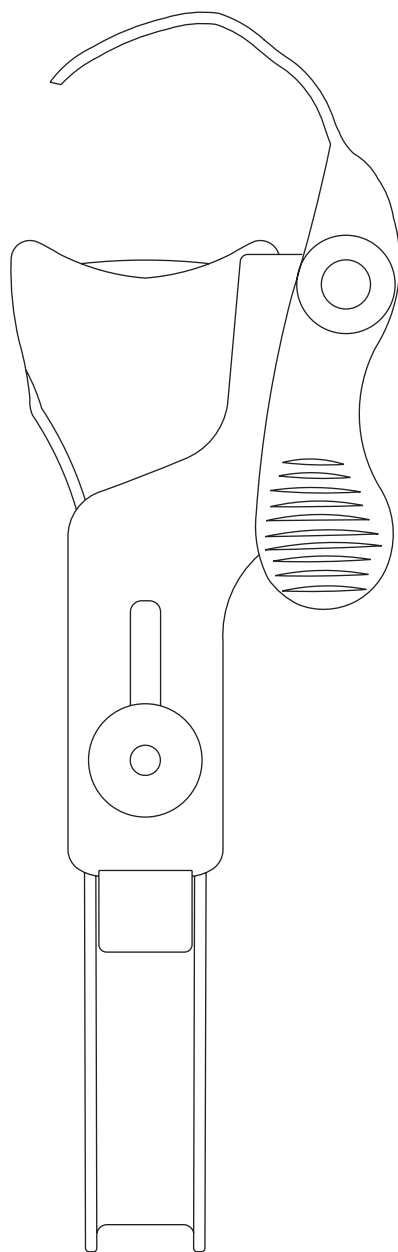
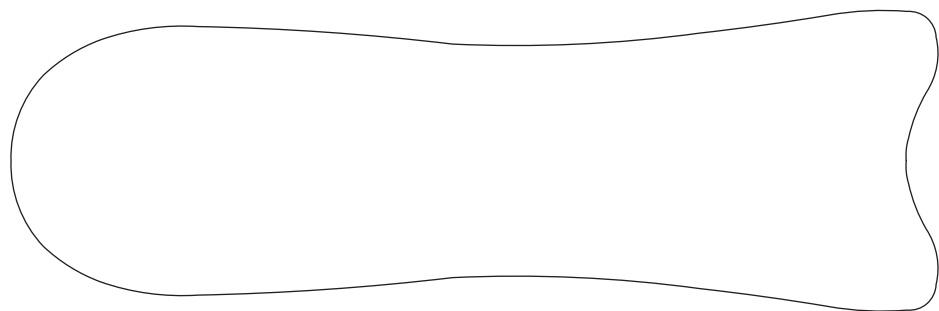

WEISMAN GRAVES

57.407.20 WEISMAN GRAVES LEFT OPEN 35MM X 115MM

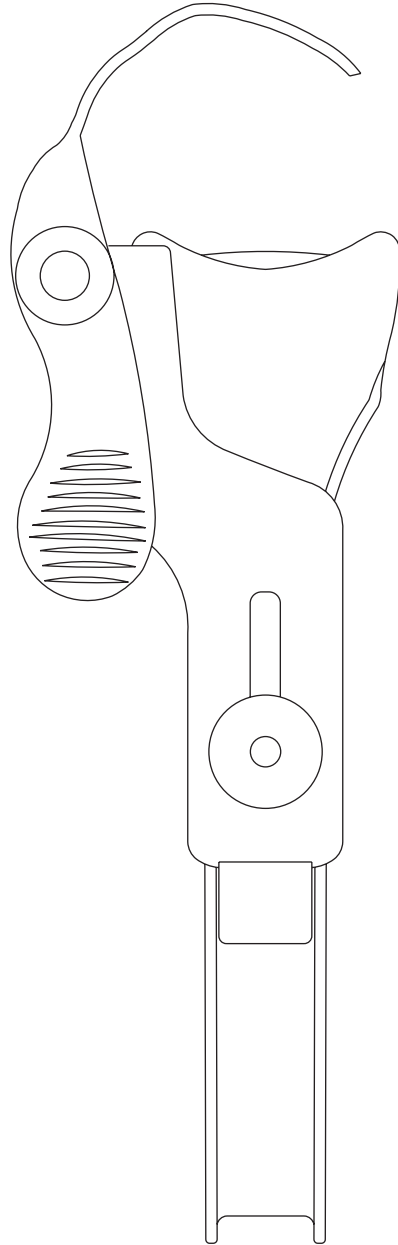
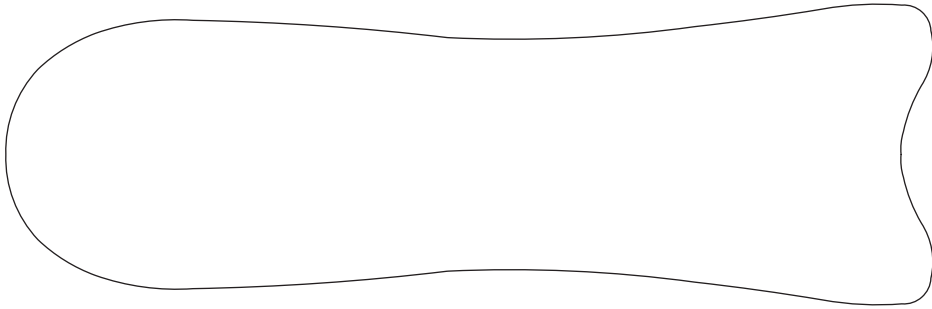

57.407.40 WEISMAN GRAVES RIGHT OPEN 35MM X 115MM

PEDERSON

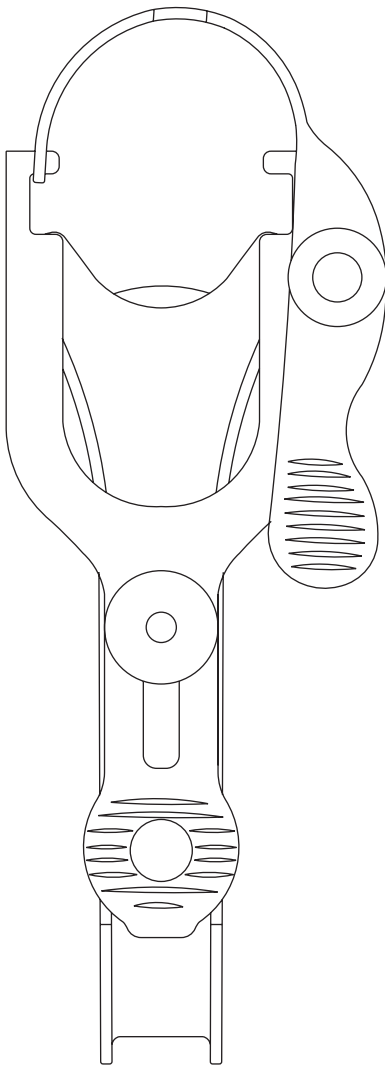

- 57.410.10 PEDERSON NARROW 17MM X 100MM
- 57.410.20 PEDERSON SMALL 13MM X 75MM
- 57.410.30 PEDERSON MEDIUM 22MM X 100MM
- 57.410.40 PEDERSON LARGE 25MM X 120MM

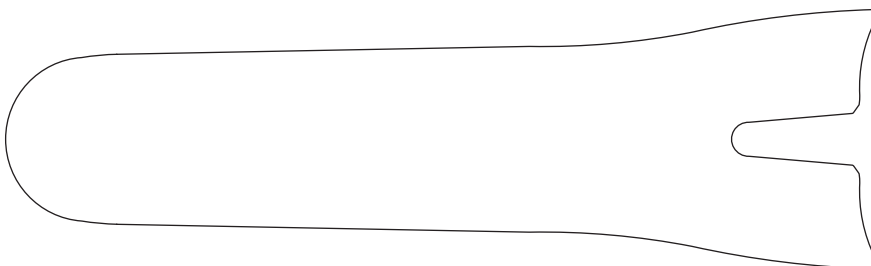

SPECULUMS

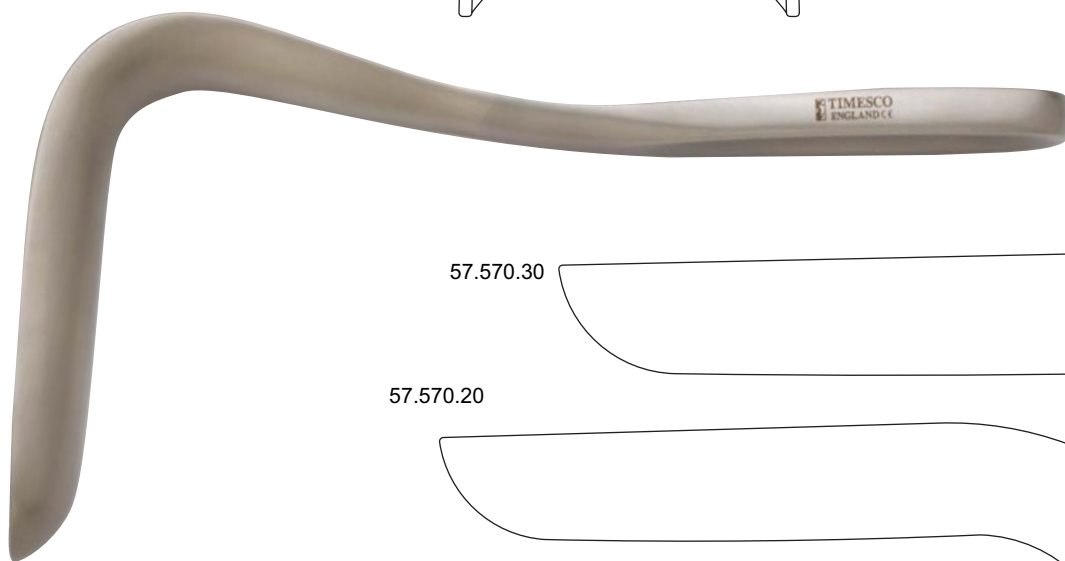
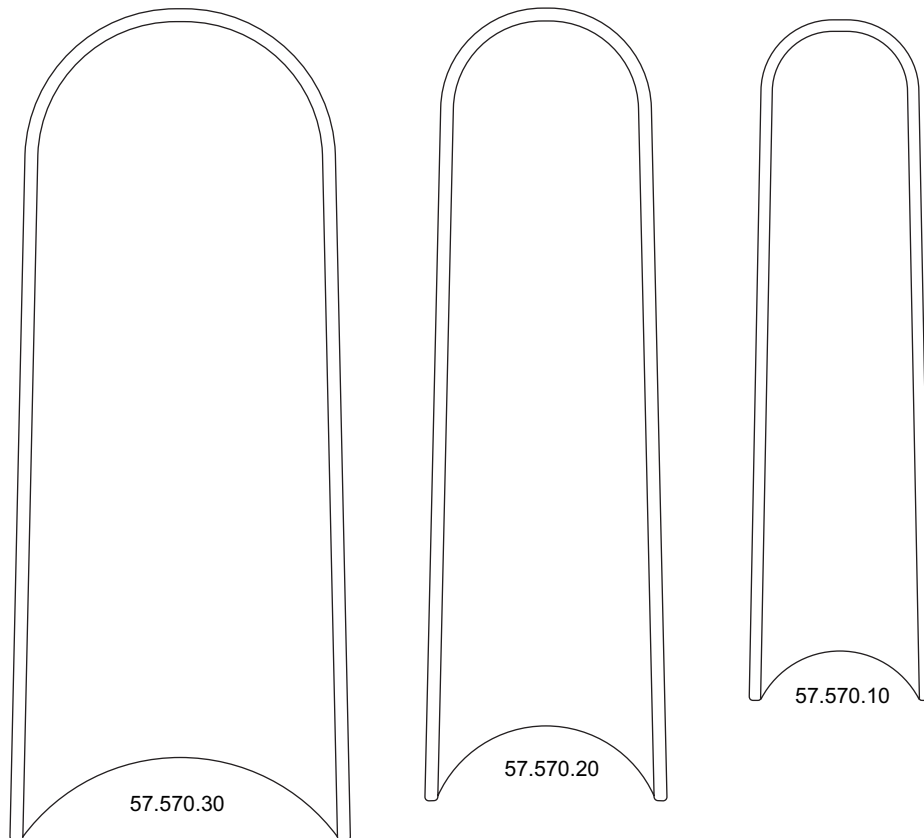

SIMS

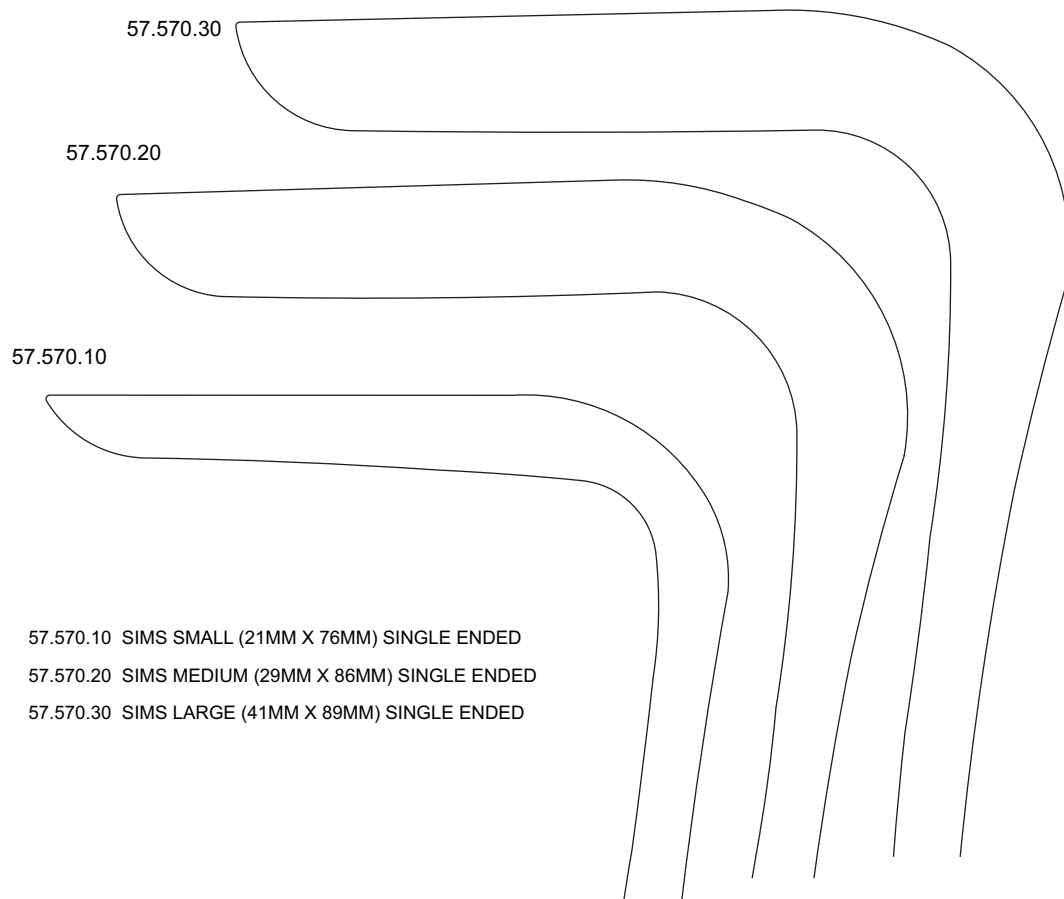

- 57.570.10 SIMS SMALL (21MM X 76MM) SINGLE ENDED
- 57.570.20 SIMS MEDIUM (29MM X 86MM) SINGLE ENDED
- 57.570.30 SIMS LARGE (41MM X 89MM) SINGLE ENDED

SPECULUMS

57.575.20

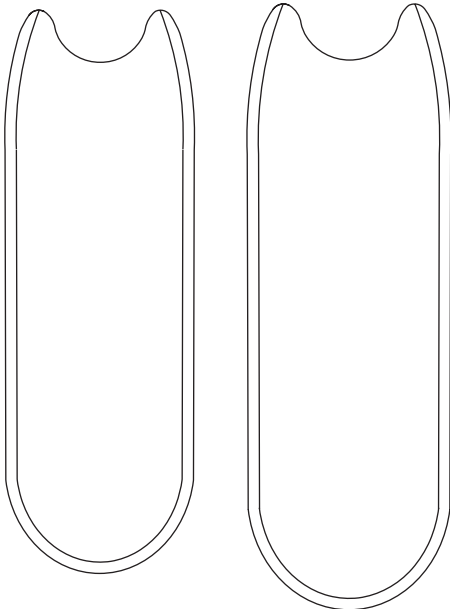

57.575.30

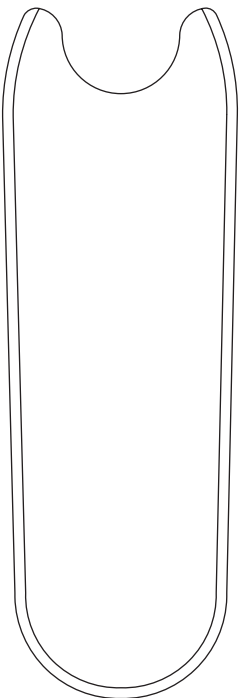

57.575.40



57.575.30



57.575.20

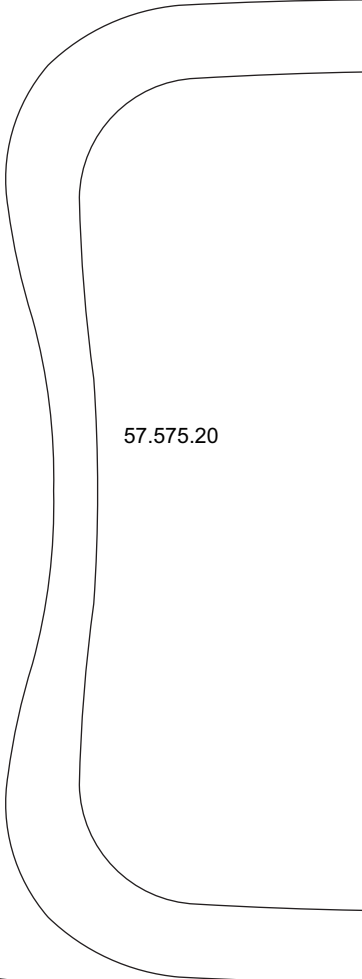

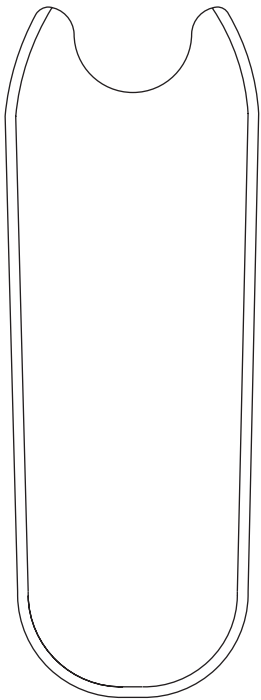

57.575.40

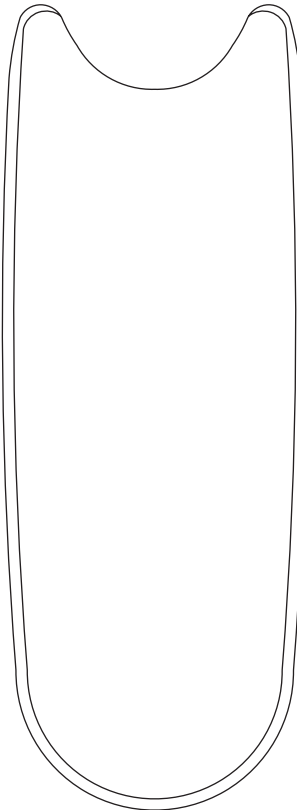
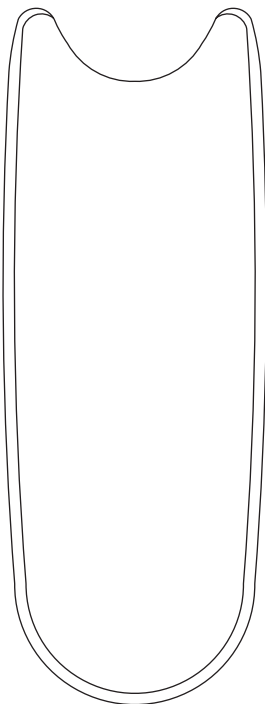

- 57.575.20 SIMS SMALL DOUBLE ENDED (26MM X 75MM) (30MM X 75MM)
- 57.575.30 SIMS MEDIUM DOUBLE ENDED (30MM X 75MM) (35MM X 80MM)
- 57.575.40 SIMS LARGE DOUBLE ENDED (36MM X 80MM) (40MM X 90MM)

SPECULUMS

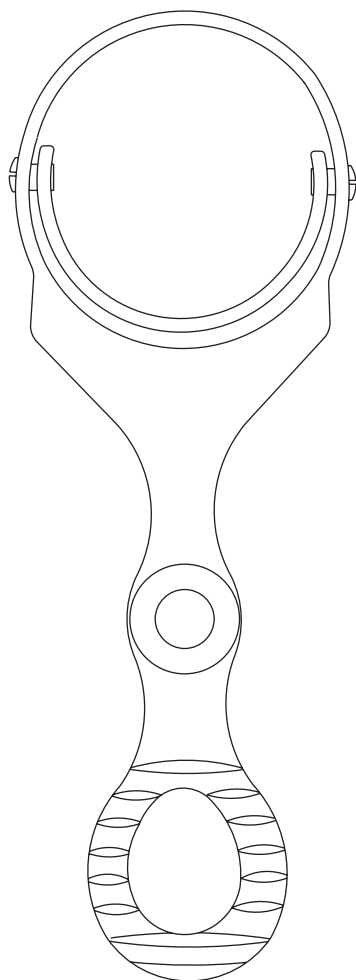
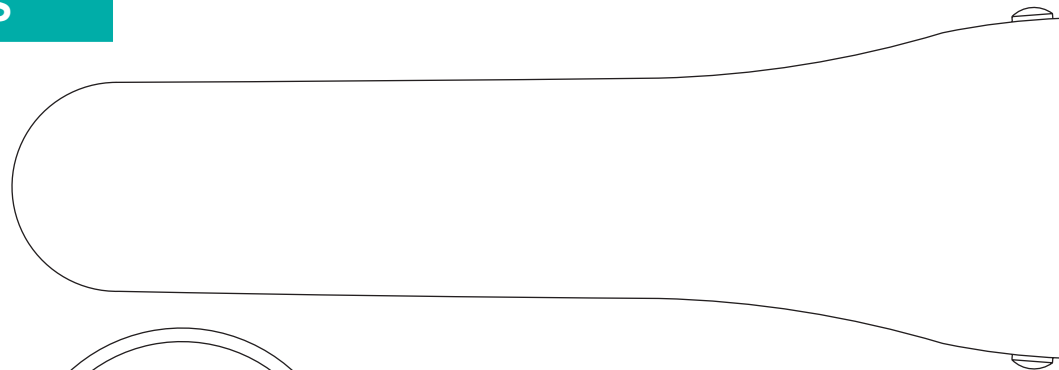

57.620.20 WINTERTON VAGINAL 27MM X 115MM



WINTERTON

LATERAL WALL RETRACTORS

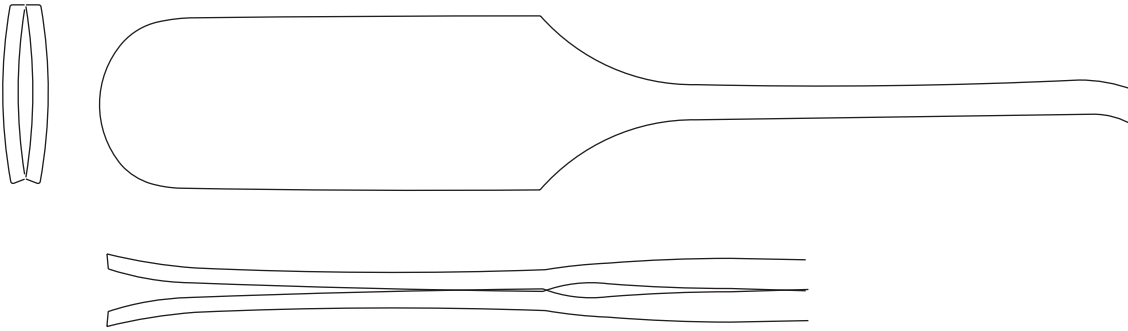

57.615.20S TIMESCO VAGINAL 9.75" (25CM)

Wall retraction up to maximum 2"



Restricted cervix exposure without Timesco lateral retractor being used.

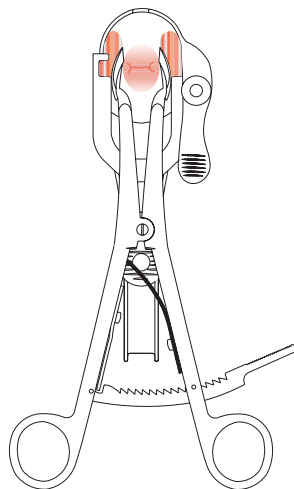

Full cervix exposure with Timesco lateral retractor.

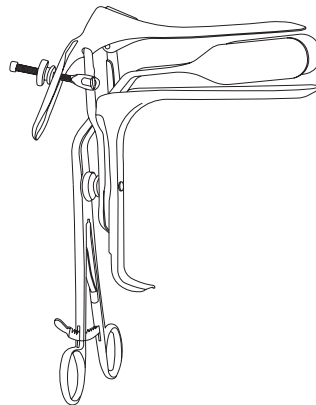

Timesco lateral retractor being used through the Graves speculum.

LATERAL WALL RETRACTORS

For procedures where a clear visualisation is required for the cervix, eg. loop conisation, Biopsy procedures etc, which the standard speculums cannot provide, the Timesco lateral (wall) vaginal retractors are ideal.

These are inserted after the introduction of the vaginal speculum, and opened, allowing the lateral side walls of the vagina being depressed out allowing an unobtrusive view of the cervix. Please see illustration.

An extra wide opening retractor, with 3" opening jaws is also available, which is best applied with a Graves 'wide' pattern speculum.

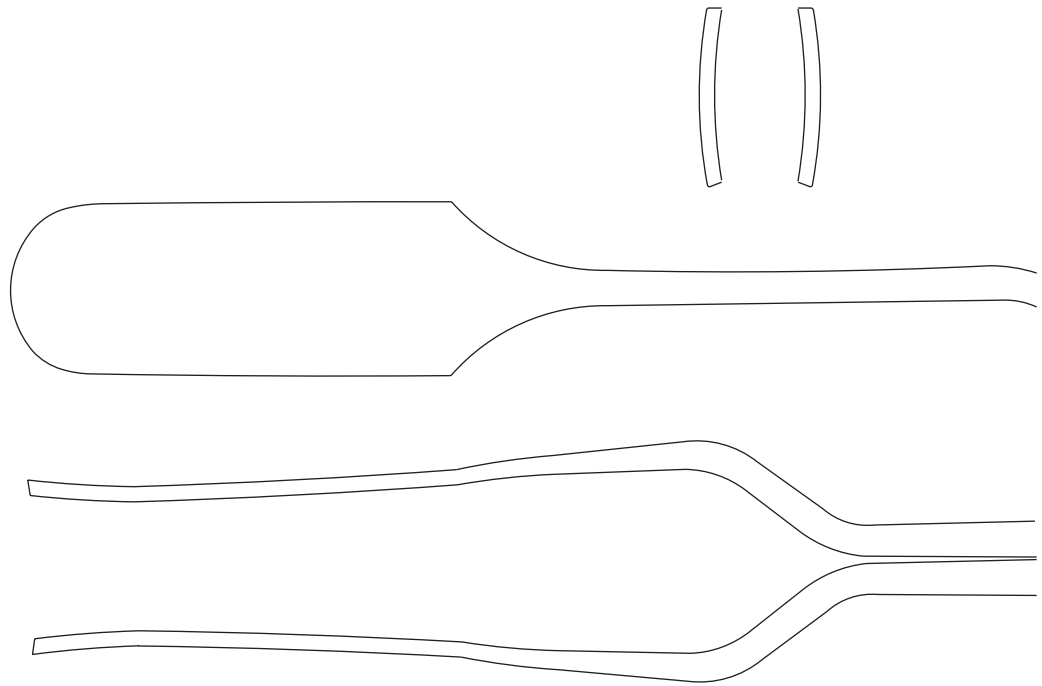

57.618.20S TIMESCO VAGINAL 9.75" X 3" (25CM X 7.5CM) OPEN

Wall retraction up to maximum 3"

BIOSY FORCEPS

Timesco produce an extensive range of Biopsy forceps for cervical specimens. Many bite (Biopsy) sizes, shapes are available.

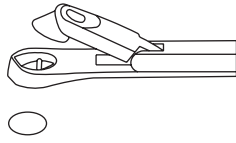

57.625.20S BURKE 8.5" (21.5CM) SHAFT

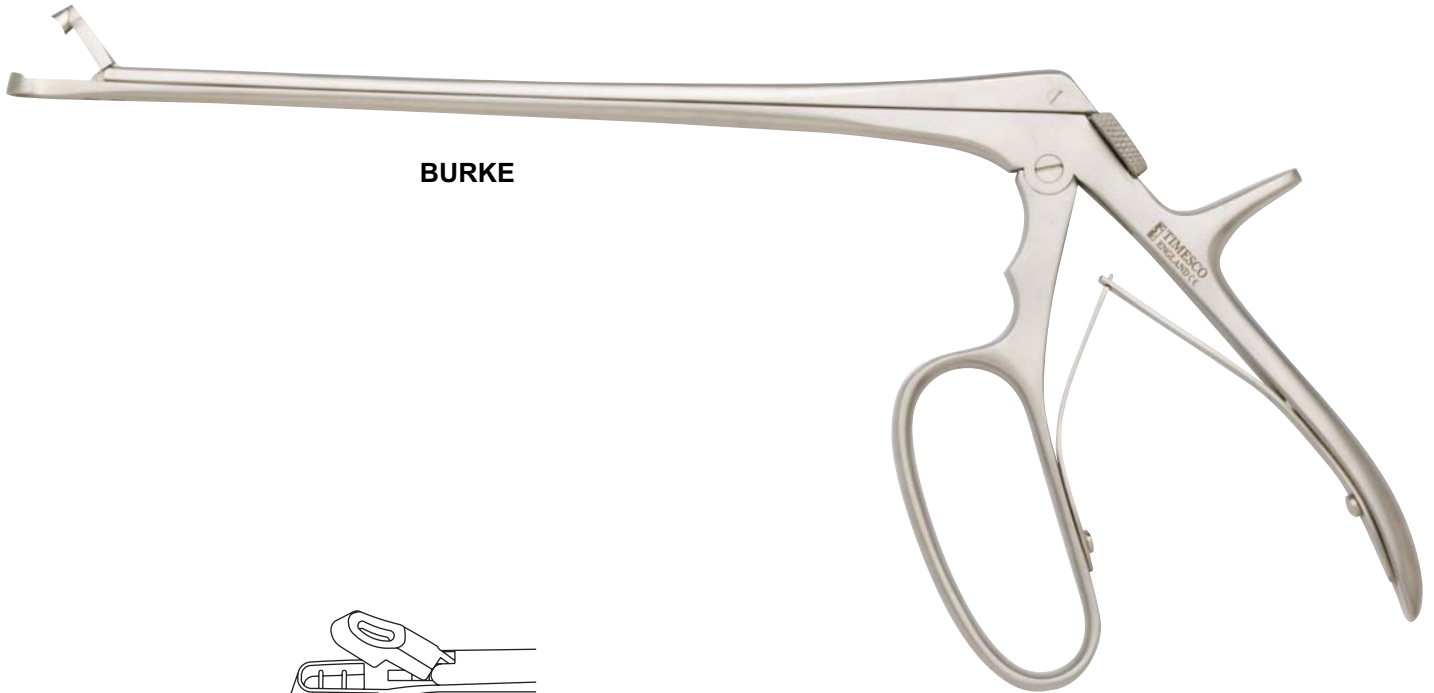

BURKE

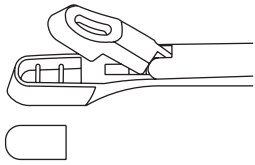

57.630.10 EPPENDORF 8" (20CM) SHAFT

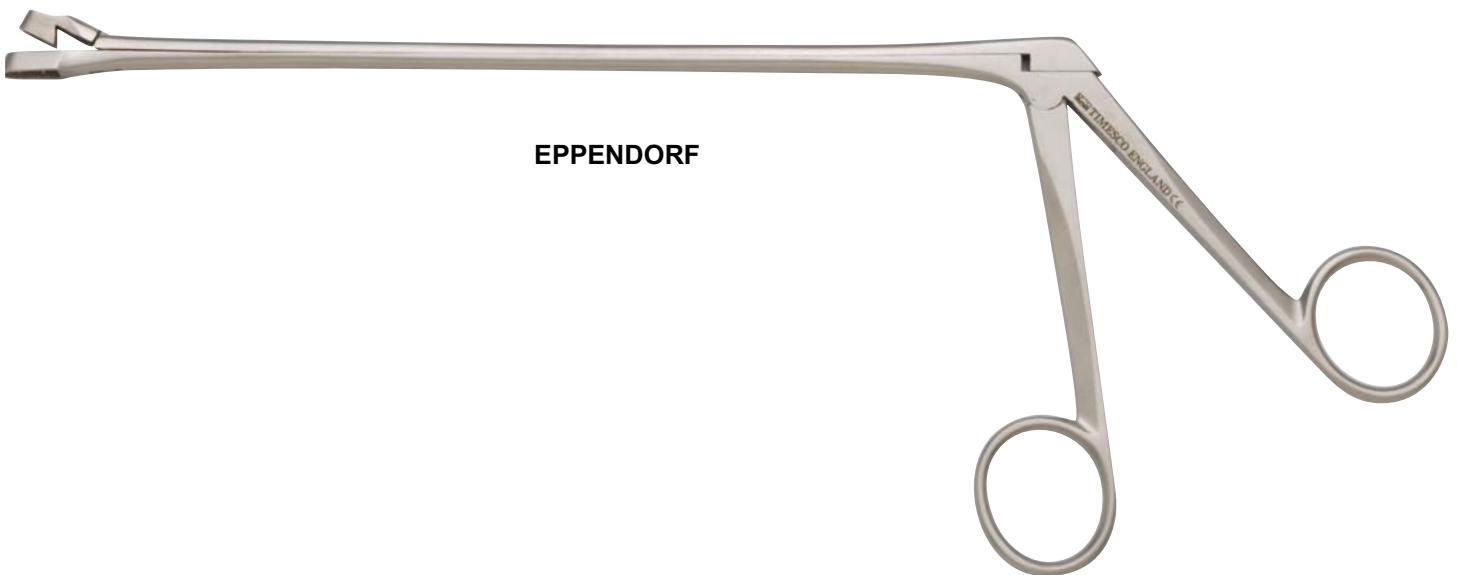

EPPENDORF

BIOPSY FORCEPS

The powerful crocodile action forceps such as Tischler, Burke, Kevorkian also have a special lock feature, which keeps the jaw closed after the Biopsy has been taken.

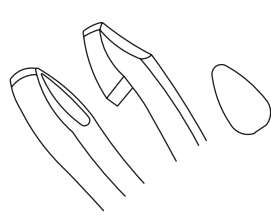

57.640.10 FAURE 8.25" (21.5CM)

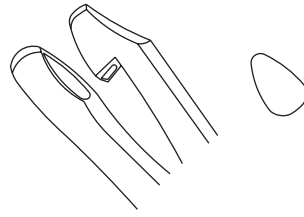

57.640.20 FAURE 9.5" (21.5CM)

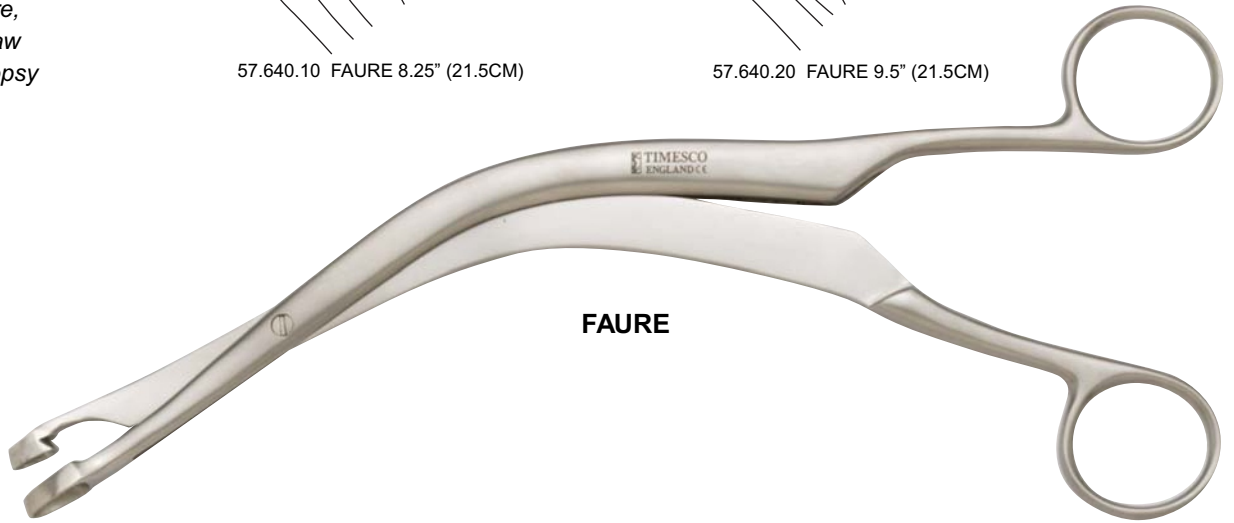

FAURE

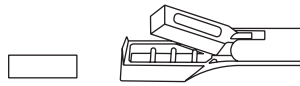

57.658.20S KEVORKIAN YOUNG 10" (25.5CM) SHAFT

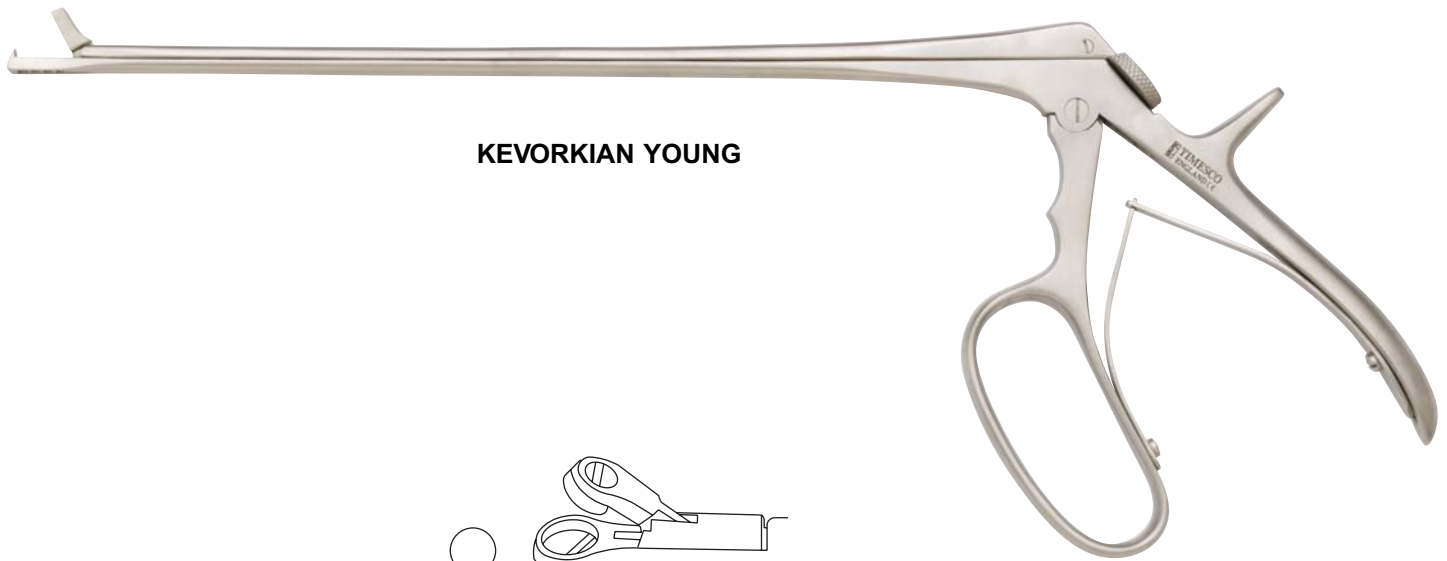

KEVORKIAN YOUNG

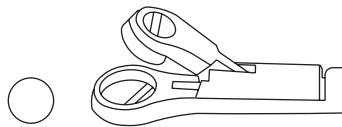

57.660.20 LEECH WILKINSON 8" (20CM) SHAFT ROUND



LEECH WILKINSON

All Timesco Biopsy forceps are made from specially hardened cutting jaws, which excise tissue with minimum hand fatigue.

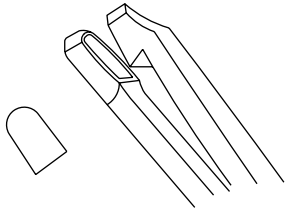

57.675.20 SCHUBERT 10.25" (20CM) BOX JOINT

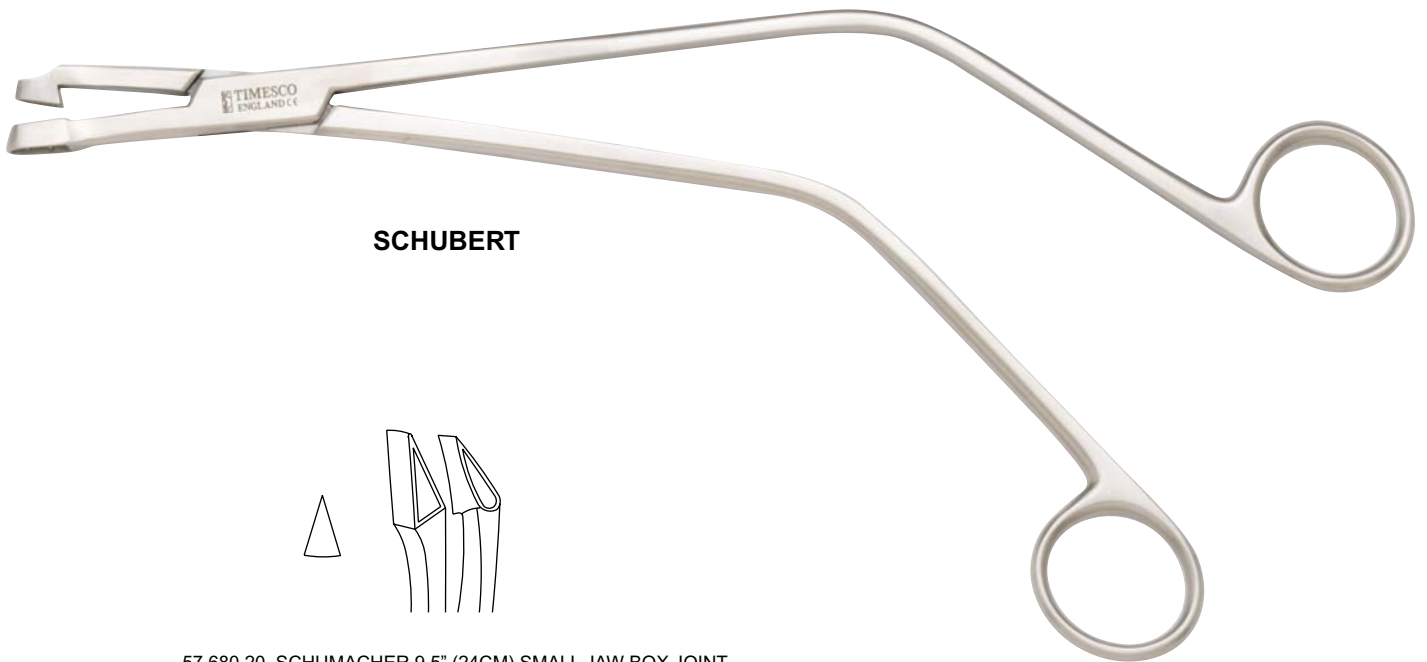

SCHUBERT

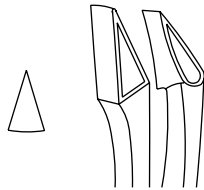

57.680.20 SCHUMACHER 9.5" (24CM) SMALL JAW BOX JOINT

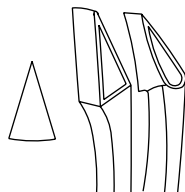

57.680.40 SCHUMACHER 9.5" (24CM) LARGE JAW BOX JOINT

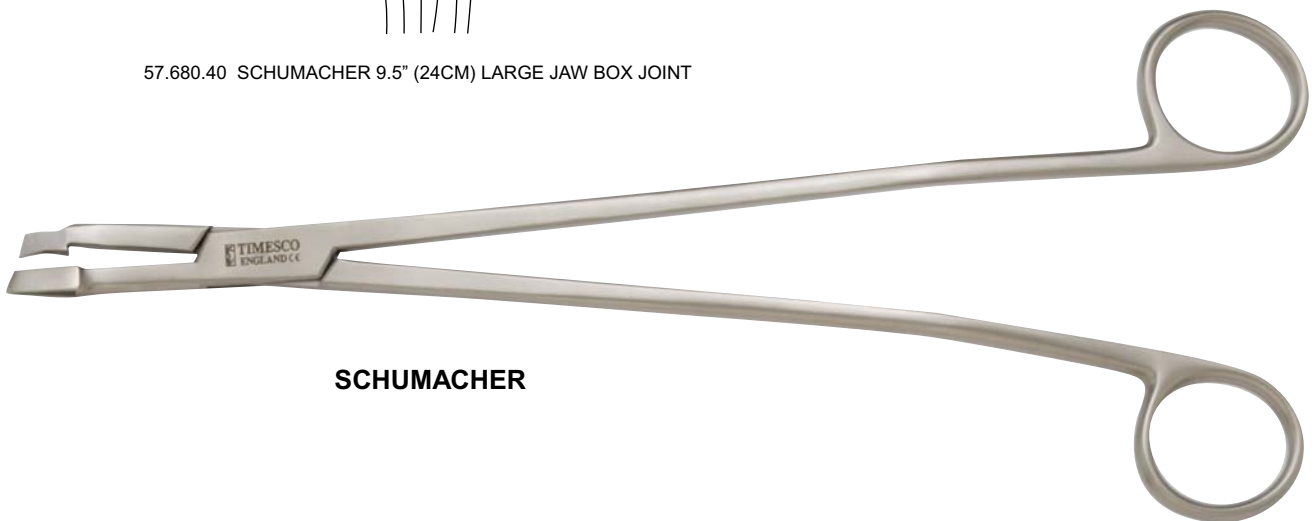

SCHUMACHER

BIOPSY FORCEPS

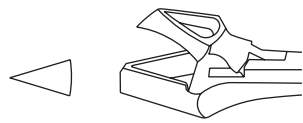

57.685.20 SCHUMACHER SMALL JAW 9.5" (24CM) SHAFT

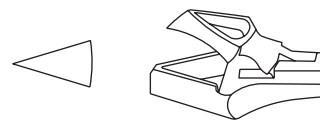

57.685.40 SCHUMACHER LARGE JAW 9.5" (24CM) SHAFT



SCHUMACHER

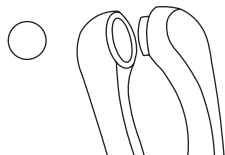

57.695.20 THOMS-GAYLOR 8.75" (22CM) BOX JOINT

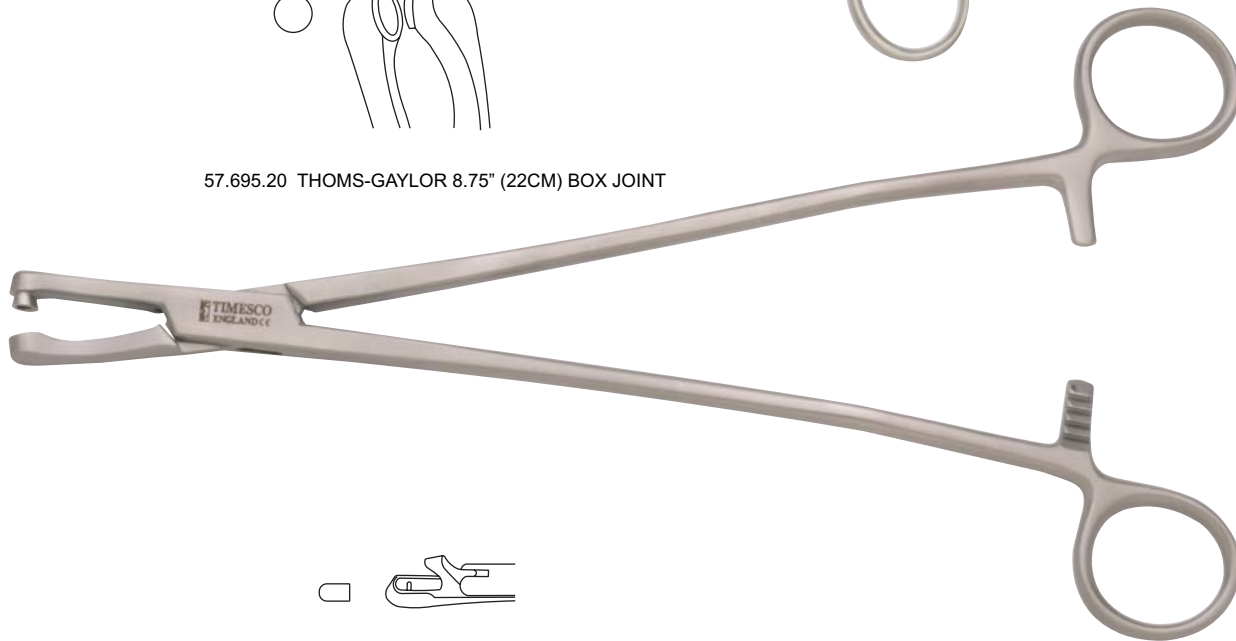

57.700.20S TISCHLER BABY 8.5" (21.5CM) SHAFT



TISCHLER BABY

TISCHLER

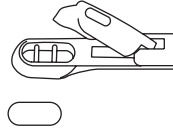
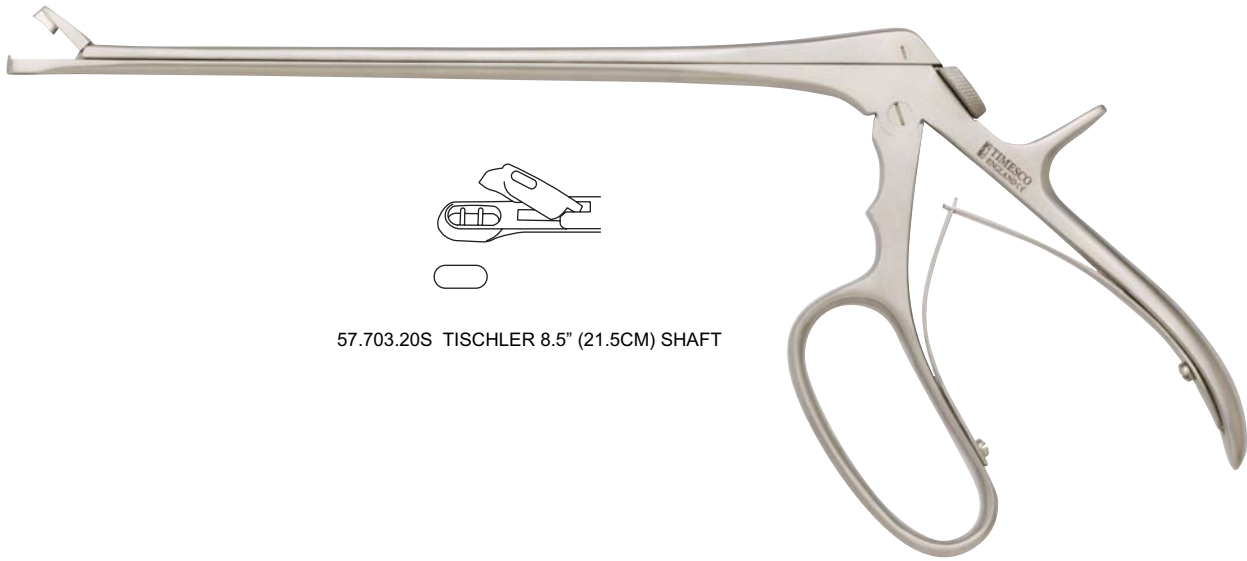

57.703.20S TISCHLER 8.5" (21.5CM) SHAFT

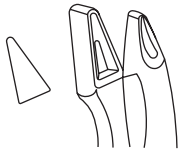

57.710.20 VAN DORAN 10.5" (27CM) BOX JOINT



VAN DORAN

WITTNER

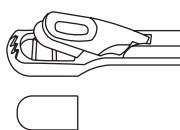
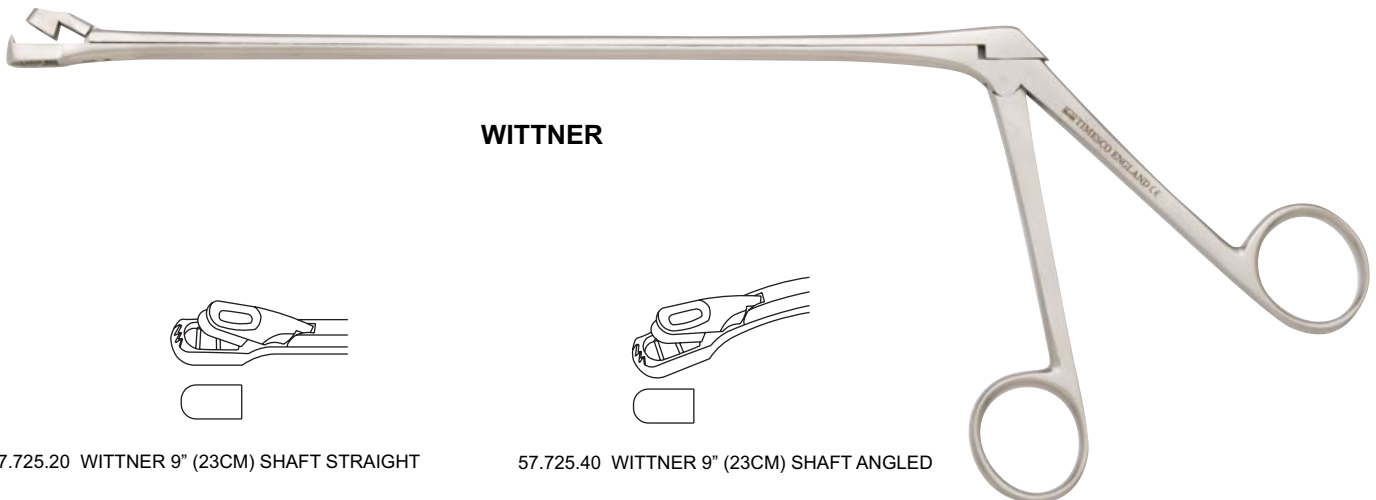

57.725.20 WITTNER 9" (23CM) SHAFT STRAIGHT

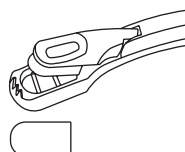

57.725.40 WITTNER 9" (23CM) SHAFT ANGLED

DILATORS

Many varieties of Dilators are available. Timesco is only showing in this catalogue the most popular European and North American designs.

Dilator diameters
in MM.

0.5 •

1 •

2 ○

3 ○

4 ○

5 ○

6 ○

7 ○

8 ○

9 ○

10 ○

11 ○

12 ○

13 ○

14 ○

15 ○

16 ○

17 ○

- 57.735.05 BONNEY - BARKER 7.25" (18.5CM) 3-4-5 MM
- 57.735.10 BONNEY - BARKER 7.25" (18.5CM) 4-5-6 MM
- 57.735.15 BONNEY - BARKER 7.25" (18.5CM) 5-6-7 MM
- 57.735.20 BONNEY - BARKER 7.25" (18.5CM) 6-7-8 MM
- 57.735.25 BONNEY - BARKER 7.25" (18.5CM) 7-8-9 MM
- 57.735.30 BONNEY - BARKER 7.25" (18.5CM) 8-9-10 MM
- 57.735.35 BONNEY - BARKER 7.25" (18.5CM) 9-10-11 MM
- 57.735.40 BONNEY - BARKER 7.25" (18.5CM) 10-11-12 MM
- 57.735.45 BONNEY - BARKER 7.25" (18.5CM) 11-12-13 MM
- 57.735.50 BONNEY - BARKER 7.25" (18.5CM) 12-13-14 MM
- 57.735.55 BONNEY - BARKER 7.25" (18.5CM) 13-14-15 MM
- 57.735.60 BONNEY - BARKER 7.25" (18.5CM) 14-15-16 MM
- 57.735.65 BONNEY - BARKER 7.25" (18.5CM) 15-16-17 MM
- 57.735.70 BONNEY - BARKER 7.25" (18.5CM) 16-17-18 MM
- 57.735.75 BONNEY - BARKER 7.25" (18.5CM) 17-18-19 MM
- 57.735.80 BONNEY - BARKER 7.25" (18.5CM) 18-19-20 MM
- 57.735.90 BONNEY - BARKER SET-16 7.5" (19MM)
- 57.735.95 BONNEY - BARKER CANVAS ROLL



BONNEY - BARKER

- 57.740.10 HANK DOUBLE ENDED 10.5" (27CM) 9/10MM
- 57.740.20 HANK DOUBLE ENDED 10.5" (27CM) 11/12 MM
- 57.740.30 HANK DOUBLE ENDED 10.5" (27CM) 13/14 MM
- 57.740.40 HANK DOUBLE ENDED 10.5" (27CM) 15/16 MM
- 57.740.50 HANK DOUBLE ENDED 10.5" (27CM) 17/18 MM
- 57.740.60 HANK DOUBLE ENDED 10.5" (27CM) 19/20 MM
- 57.740.90 HANK SET 6 D/E 9/10- 19/20MM



HANK

All Timesco dilators are made in super smooth finish, exacting curvatures, which allow easier insertion to dilate the cervix. The Hegar dilators, which are now by far the most popular pattern, especially the double-ended pattern, are also available in special 1/2 sizes on request.

Wherever available all dilators sets are supplied in canvas/rexin wraps.

- 57.760.10 HAWKIN AMBLER 6.75" (17CM) 6-3 MM
- 57.760.15 HAWKIN AMBLER 6.75" (17CM) 4-7 MM
- 57.760.20 HAWKIN AMBLER 6.75" (17CM) 5-8 MM
- 57.760.25 HAWKIN AMBLER 6.75" (17CM) 6-9 MM
- 57.760.30 HAWKIN AMBLER 6.75" (17CM) 7-10 MM
- 57.760.35 HAWKIN AMBLER 6.75" (17CM) 8-11 MM
- 57.760.40 HAWKIN AMBLER 6.75" (17CM) 9-12 MM
- 57.760.45 HAWKIN AMBLER 6.75" (17CM) 10-13 MM
- 57.760.50 HAWKIN AMBLER 6.75" (17CM) 11-14 MM
- 57.760.55 HAWKIN AMBLER 6.75" (17CM) 12-15 MM
- 57.760.60 HAWKIN AMBLER 6.75" (17CM) 13-16 MM
- 57.760.65 HAWKIN AMBLER 6.75" (17CM) 14-17 MM
- 57.760.70 HAWKIN AMBLER 6.75" (17CM) 15-18 MM
- 57.760.75 HAWKIN AMBLER 6.75" (17CM) 16-19 MM
- 57.760.80 HAWKIN AMBLER 6.75" (17CM) 17-20 MM
- 57.760.85 HAWKIN AMBLER 6.75" (17CM) 18-21 MM
- 57.760.90 HAWKIN AMBLER SET OF 16, 3/6-18/21MM
- 57.760.95 HAWKIN AMBLER CANVAS ROLL ONLY



HAWKIN AMBLER

- | | |
|--|--|
| 57.770.05 HEGAR SINGLE ENDED 7.25" (18.5CM) 2MM | 57.770.40 HEGAR SINGLE ENDED 7.25" (18.5CM) 16MM |
| 57.770.08 HEGAR SINGLE ENDED 7.25" (18.5CM) 3MM | 57.770.42 HEGAR SINGLE ENDED 7.25" (18.5CM) 17MM |
| 57.770.10 HEGAR SINGLE ENDED 7.25" (18.5CM) 4MM | 57.770.45 HEGAR SINGLE ENDED 7.25" (18.5CM) 18MM |
| 57.770.12 HEGAR SINGLE ENDED 7.25" (18.5CM) 5MM | 57.770.48 HEGAR SINGLE ENDED 7.25" (18.5CM) 19MM |
| 57.770.15 HEGAR SINGLE ENDED 7.25" (18.5CM) 6MM | 57.770.50 HEGAR SINGLE ENDED 7.25" (18.5CM) 20MM |
| 57.770.18 HEGAR SINGLE ENDED 7.25" (18.5CM) 7MM | 57.770.52 HEGAR SINGLE ENDED 7.25" (18.5CM) 21MM |
| 57.770.20 HEGAR SINGLE ENDED 7.25" (18.5CM) 8MM | 57.770.55 HEGAR SINGLE ENDED 7.25" (18.5CM) 22MM |
| 57.770.22 HEGAR SINGLE ENDED 7.25" (18.5CM) 9MM | 57.770.58 HEGAR SINGLE ENDED 7.25" (18.5CM) 23MM |
| 57.770.25 HEGAR SINGLE ENDED 7.25" (18.5CM) 10MM | 57.770.60 HEGAR SINGLE ENDED 7.25" (18.5CM) 24MM |
| 57.770.28 HEGAR SINGLE ENDED 7.25" (18.5CM) 11MM | 57.770.62 HEGAR SINGLE ENDED 7.25" (18.5CM) 25MM |
| 57.770.30 HEGAR SINGLE ENDED 7.25" (18.5CM) 12MM | 57.770.65 HEGAR SINGLE ENDED 7.25" (18.5CM) 26MM |
| 57.770.32 HEGAR SINGLE ENDED 7.25" (18.5CM) 13MM | 57.770.90 HEGAR SET OF 12 S/E 3-14MM |
| 57.770.35 HEGAR SINGLE ENDED 7.25" (18.5CM) 14MM | 57.770.96 HEGAR SET 12 S/E CANVAS ONLY |
| 57.770.38 HEGAR SINGLE ENDED 7.25" (18.5CM) 15MM | |



HEGAR

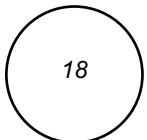

18

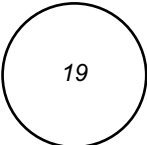

19

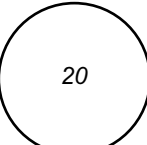

20

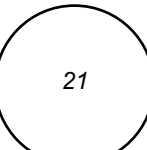

21

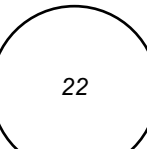

22

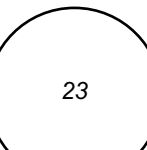

23

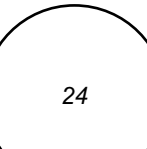

24

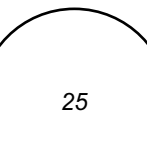

25

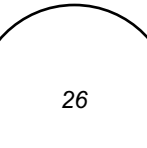

26

Please refer to the back of the publication for MM/FG/EG comparison chart.

The majority of dilators have fixed sizes along their length, some however, eg. 'Bonney Barker' are tapered, with a smaller size at the tip, gradually getting bigger at the base. These tapering dilators allow cervical dilations to be done (eg. three steps) with minimal use of individual dilators.

DILATORS

As an ongoing process, all dilators are being made from stainless steel, some like the Hawkin Amblers are still supplied in electroplated versions. All dilators are available in set configurations. We have listed the most popular set combinations.

- 57.790.05 HEGAR DOUBLE ENDED 8" (20CM) 1/2MM
- 57.790.08 HEGAR DOUBLE ENDED 8" (20CM) 3/4MM
- 57.790.10 HEGAR DOUBLE ENDED 8" (20CM) 5/6MM
- 57.790.12 HEGAR DOUBLE ENDED 8" (20CM) 7/8MM
- 57.790.15 HEGAR DOUBLE ENDED 8" (20CM) 9/10MM
- 57.790.18 HEGAR DOUBLE ENDED 8" (20CM) 11/12MM
- 57.790.20 HEGAR DOUBLE ENDED 8" (20CM) 13/14MM
- 57.790.22 HEGAR DOUBLE ENDED 8" (20CM) 15/16MM
- 57.790.25 HEGAR DOUBLE ENDED 8" (20CM) 17/18MM
- 57.790.30 HEGAR DOUBLE ENDED 8" (20CM) 19/20MM
- 57.790.32 HEGAR DOUBLE ENDED 8" (20CM) 21/22MM
- 57.790.35 HEGAR DOUBLE ENDED 8" (20CM) 23/24MM
- 57.790.38 HEGAR DOUBLE ENDED 8" (20CM) 25/26MM
- 57.790.60 HEGAR SET 8 DOUBLE ENDED 3/4MM -17/18MM
- 57.790.70 HEGAR SET 12 DOUBLE ENDED 1/2MM-23/24MM
- 57.790.90 HEGAR SET 8 DOUBLE ENDED CANVAS ONLY
- 57.790.94 HEGAR SET 12 DOUBLE ENDED CANVAS ONLY



HEGAR

- 57.800.05 PRATT DOUBLE ENDED 11.5" (29CM) 13/15 FG
- 57.800.10 PRATT DOUBLE ENDED 11.5" (29CM) 17/19 FG
- 57.800.15 PRATT DOUBLE ENDED 11.5" (29CM) 21/23 FG
- 57.800.20 PRATT DOUBLE ENDED 11.5" (29CM) 25/27 FG
- 57.800.25 PRATT DOUBLE ENDED 11.5" (29CM) 29/31 FG
- 57.800.30 PRATT DOUBLE ENDED 11.5" (29CM) 33/35 FG
- 57.800.35 PRATT DOUBLE ENDED 11.5" (29CM) 37/39 FG
- 57.800.40 PRATT DOUBLE ENDED 11.5" (29CM) 41/43 FG
- 57.800.80 PRATT SET 8 DOUBLE ENDED 13/15-41/43 FG



PRATT

ENDOCERVICAL SPECULUMS

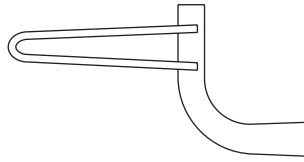

57.815.40S KOGAN 9.5" (24CM) CALIBRATED, WITH LOCK

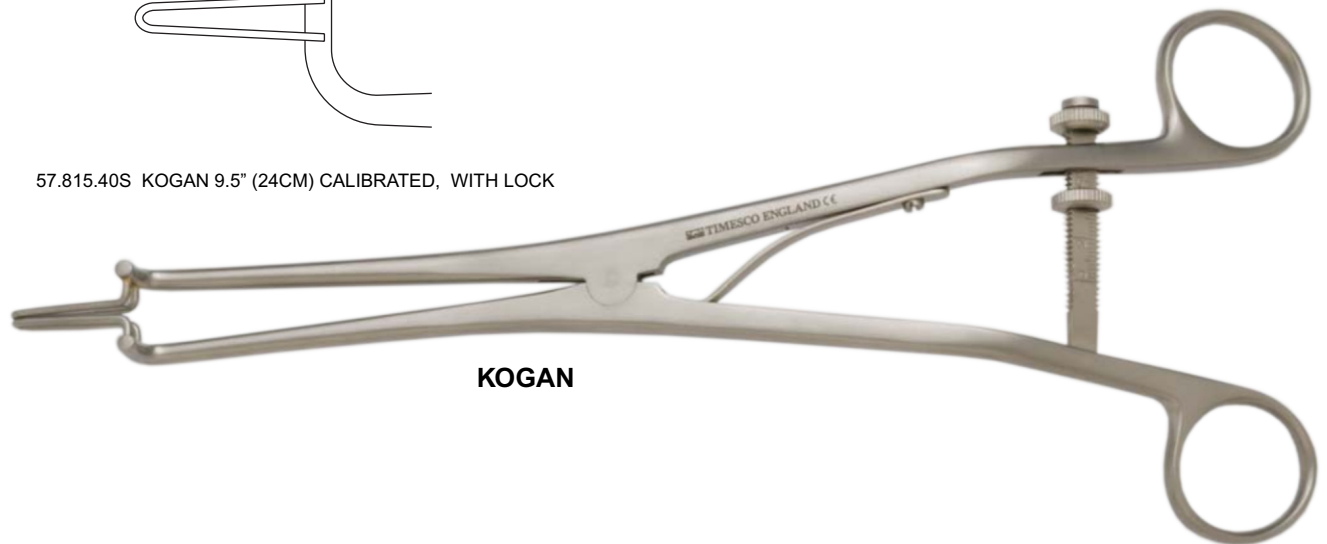

KOGAN

The Timesco Kogan Endocervical speculum has narrow wire blades, 4mm, which once introduced are opened gradually allowing gentle dilation of the cervical canal. The speculum is calibrated to control the dilation and avoid trauma.

TENACULUM / VULSELLUM FORCEPS



57.845.10S ATRAUMA STRAIGHT 9" (23CM) JAW 1/8"

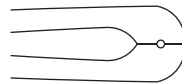

57.845.20S ATRAUMA STRAIGHT 9" (23CM) JAW 1/4"

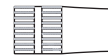

57.855.40 TIMESCO ATRAUMA 11.5" (29CM) 1/4" (0.5CM) JAW + SOUND



ATRAUMA



TIMESCO ATRAUMA

The Timesco Atrauma forceps feature a double row of longitudinally serrated, non-traumatic jaws which hold the cervix without crushing, tearing or slipping.

TENACULUM / VULSELLUM FORCEPS

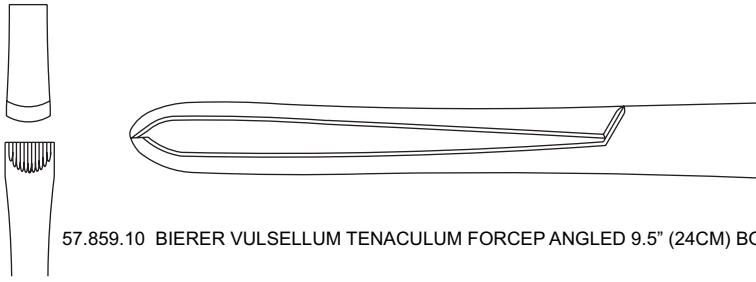

57.859.10 BIERER VULSELLUM TENACULUM FORCEP ANGLED 9.5" (24CM) BOX JOINT



BIERER

This is a popular North American style Tenaculum which due to its angled shanks allows clear unobstructed view of the cervix.

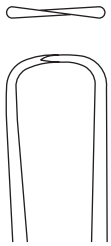

57.860.10 BRAUN VULSELLUM FORCEPS 10" (25.5CM) 1 X 1 TH BOX JOINT



BRAUN

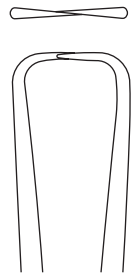

57.868.10 DUPLAY VULSELLUM FORCEPS 11" (28CM) 1 X 1 TH BOX JOINT

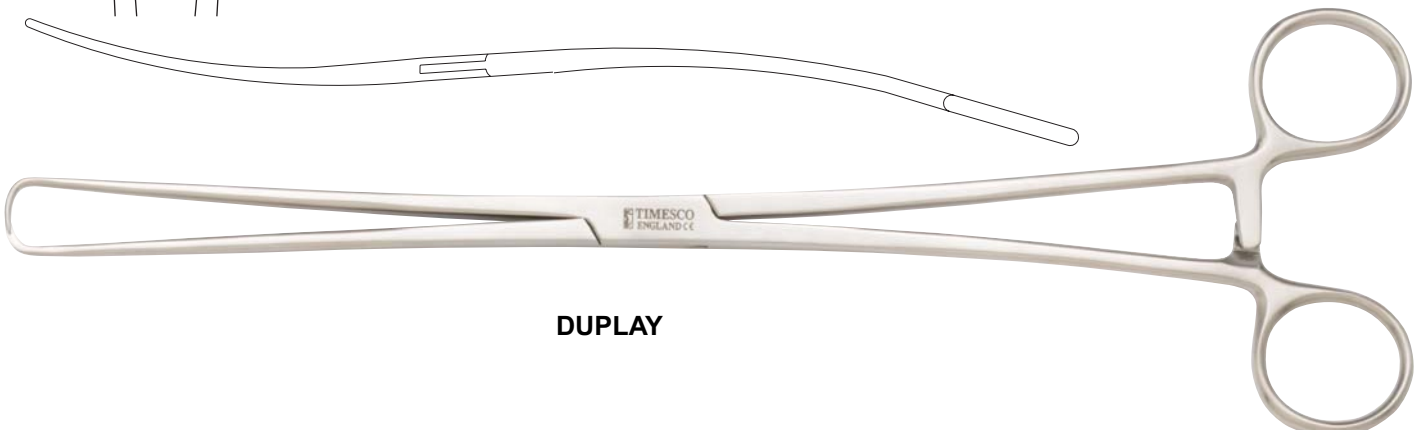

DUPLAY

TENACULUM / VULSELLUM FORCEPS



57.880.10 LEWER VULSELLUM FORCEPS 9.5" (24CM) 2 X 2 TH BOX JOINT



LEWER
(Also known as 'Museux')

These forceps are referred to either as Vulsellum or Teneculum. They perform the same function, to hold and manipulate the cervix with their sharp jaws.

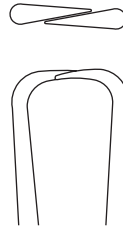

57.890.10 LUER VULSELLUM FORCEPS 9.5" (24CM) 1 X 1 TH BOX JOINT



LUER

57.891.40 TIMESCO LUER VULSELLUM + SOUND 12" (30.5CM) BOX JOINT



TIMESCO LUER

TENACULUM / VULSELLUM FORCEPS

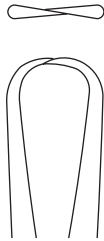

57.970.10 ROTUNDA VULSELLUM FORCEP 10.5" (27CM) 1 X 1 TH



ROTUNDA

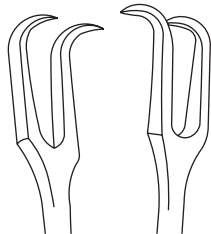

57.985.10 SCHROEDER VULSELLUM FORCEP 10.5" (27CM) 2 X 2



SCHROEDER



57.995.10 TEAL VULSELLUM STRAIGHT 9.5" (27CM) 3 X 4 TH BOX JOINT

57.995.30 TEAL VULSELLUM CURVED 7" (18CM) 3 X 4 TH BOX JOINT

57.995.40 TEAL VULSELLUM CURVED 9.5" (24CM) 3 X 4 TH BOX JOINT



TEAL

ENDOCERVICAL CURETTES

Timesco's unique set of endocervical curettes are designed with special miniature heads to obtain endocervical biopsies from the OS. Their long length also allows endometrial tissue samples if required.

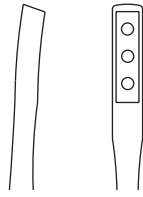

58.175.20 KEVORKIAN WITH BASKET SQUARE 12" (30.5CM)



KEVORKIAN

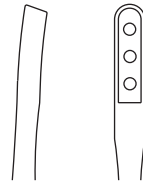

58.175.40 KEVORKIAN WITH BASKET ROUND 12" (30.5CM)



KEVORKIAN

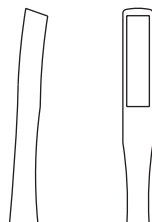

58.175.60 KEVORKIAN WITHOUT BASKET SQUARE 12" (30.5CM)



KEVORKIAN

UTERINE CURETTES

For curettage of the uterine walls Timesco produces an extensive range of curettes, some blunt edges, which are less traumatic, some sharp.



58.190.05
No. 00, 5MM



58.190.10
No. 0, 6MM



58.190.15
No. 1, 7MM



58.190.20
No. 2, 8MM

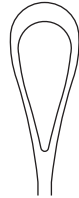

58.190.25
No. 3, 9MM



58.190.30
No. 4, 11MM



58.190.35
No. 5, 12MM

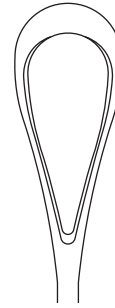

58.190.40
No. 6, 14MM

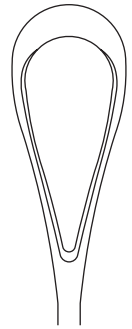

58.190.45
No. 7, 15MM

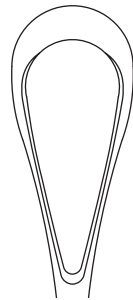

58.190.50
No. 8, 16MM

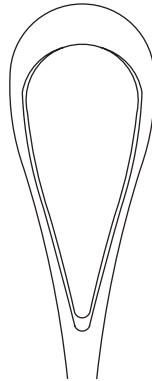

58.190.55
No. 9, 19MM

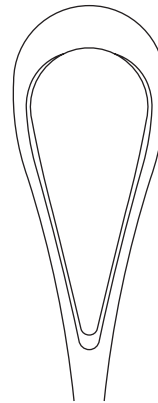

58.190.60
No. 10, 20MM

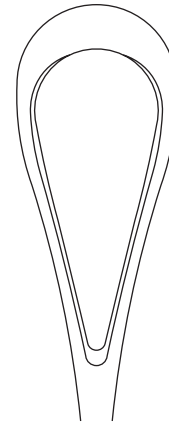

58.190.65
No. 11, 21MM

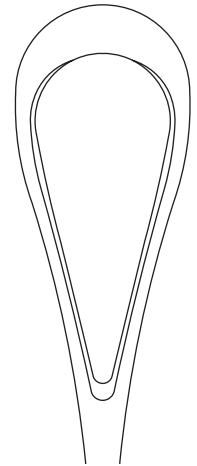

58.190.70
No. 12, 23MM

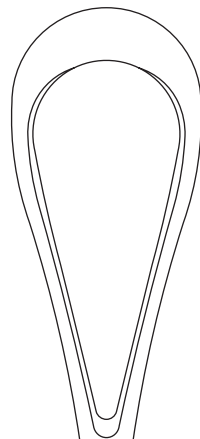

58.190.75
No. 13, 25MM

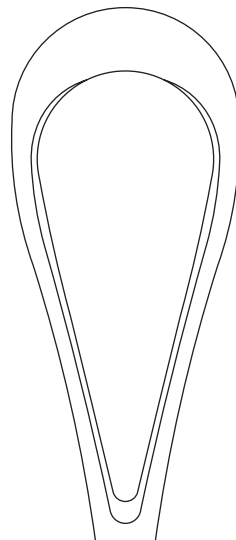

58.190.80
No. 14, 30MM

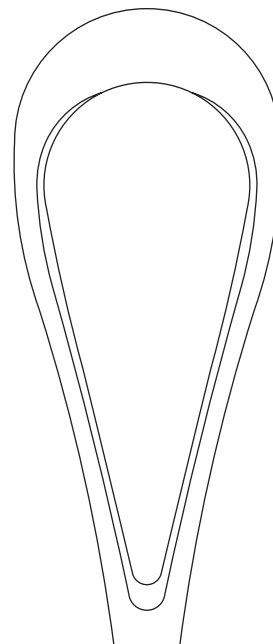

58.190.85
No. 15, 35MM

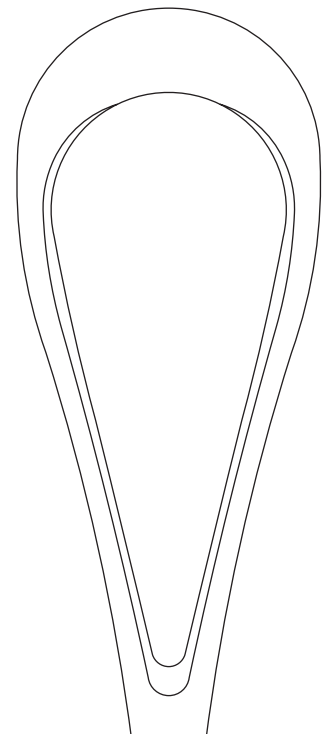

58.190.90
No. 16, 40MM

- 58.190.05 RECAMIER RIGID 00 5MM SHARP 12.5" (32CM)
- 58.190.10 RECAMIER RIGID 0 6MM SHARP 12.5" (32CM)
- 58.190.15 RECAMIER RIGID 1 7MM SHARP 12.5" (32CM)
- 58.190.20 RECAMIER RIGID 2 8MM SHARP 12.5" (32CM)
- 58.190.25 RECAMIER RIGID 3 9MM SHARP 12.5" (32CM)
- 58.190.30 RECAMIER RIGID 4 11MM SHARP 12.5" (32CM)
- 58.190.35 RECAMIER RIGID 5 12MM SHARP 12.5" (32CM)
- 58.190.40 RECAMIER RIGID 6 14MM SHARP 12.5" (32CM)
- 58.190.45 RECAMIER RIGID 7 15MM SHARP 12.5" (32CM)
- 58.190.50 RECAMIER RIGID 8 16MM SHARP 12.5" (32CM)
- 58.190.55 RECAMIER RIGID 9 19MM SHARP 12.5" (32CM)
- 58.190.60 RECAMIER RIGID 10 20MM SHARP 12.5" (32CM)
- 58.190.65 RECAMIER RIGID 11 21MM SHARP 12.5" (32CM)
- 58.190.70 RECAMIER RIGID 12 23MM SHARP 12.5" (32CM)
- 58.190.75 RECAMIER RIGID 13 25MM SHARP 12.5" (32CM)
- 58.190.80 RECAMIER RIGID 14 30MM SHARP 12.5" (32CM)
- 58.190.85 RECAMIER RIGID 15 35MM SHARP 12.5" (32CM)
- 58.190.90 RECAMIER RIGID 16 40MM SHARP 12.5" (32CM)

As well as single and double ended curettes, some, eg. Recamier, have malleable shafts, which can be bent to shape.

Curettes are also referred to as 'spoons'!

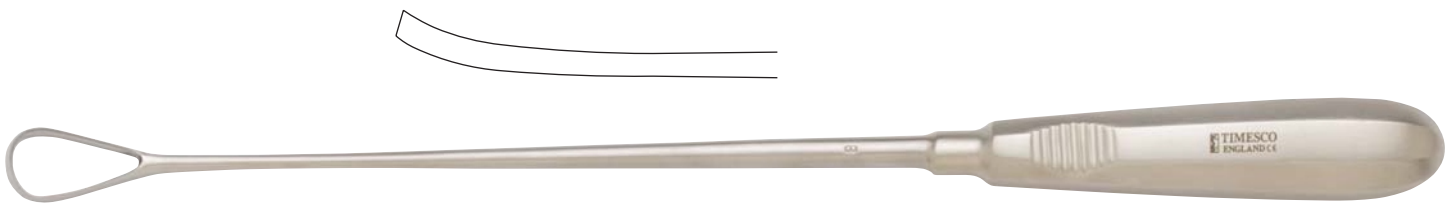

RECAMIER

- 58.195.05 RECAMIER MALLEABLE 00 5MM SHARP 12.5" (32CM)
- 58.195.10 RECAMIER MALLEABLE 0 6MM SHARP 12.5" (32CM)
- 58.195.15 RECAMIER MALLEABLE 1 7MM SHARP 12.5" (32CM)
- 58.195.20 RECAMIER MALLEABLE 2 8MM SHARP 12.5" (32CM)
- 58.195.25 RECAMIER MALLEABLE 3 9MM SHARP 12.5" (32CM)
- 58.195.30 RECAMIER MALLEABLE 4 11MM SHARP 12.5" (32CM)
- 58.195.35 RECAMIER MALLEABLE 5 12MM SHARP 12.5" (32CM)
- 58.195.40 RECAMIER MALLEABLE 6 14MM SHARP 12.5" (32CM)
- 58.195.45 RECAMIER MALLEABLE 7 15MM SHARP 12.5" (32CM)
- 58.195.50 RECAMIER MALLEABLE 8 16MM SHARP 12.5" (32CM)
- 58.195.55 RECAMIER MALLEABLE 9 19MM SHARP 12.5" (32CM)
- 58.195.60 RECAMIER MALLEABLE 10 20MM SHARP 12.5" (32CM)
- 58.195.65 RECAMIER MALLEABLE 11 21MM SHARP 12.5" (32CM)
- 58.195.70 RECAMIER MALLEABLE 12 23MM SHARP 12.5" (32CM)
- 58.195.75 RECAMIER MALLEABLE 13 25MM SHARP 12.5" (32CM)
- 58.195.80 RECAMIER MALLEABLE 14 30MM SHARP 12.5" (32CM)
- 58.195.85 RECAMIER MALLEABLE 15 35MM SHARP 12.5" (32CM)
- 58.195.90 RECAMIER MALLEABLE 16 40MM SHARP 12.5" (32CM)

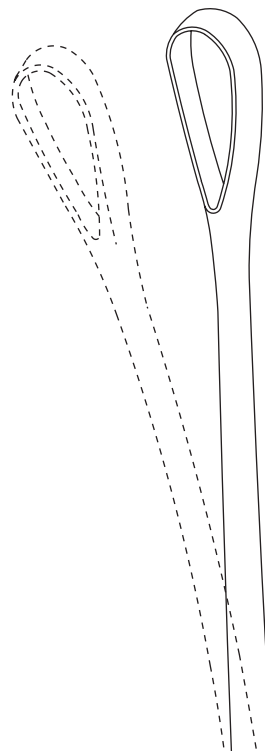

UTERINE CURETTES

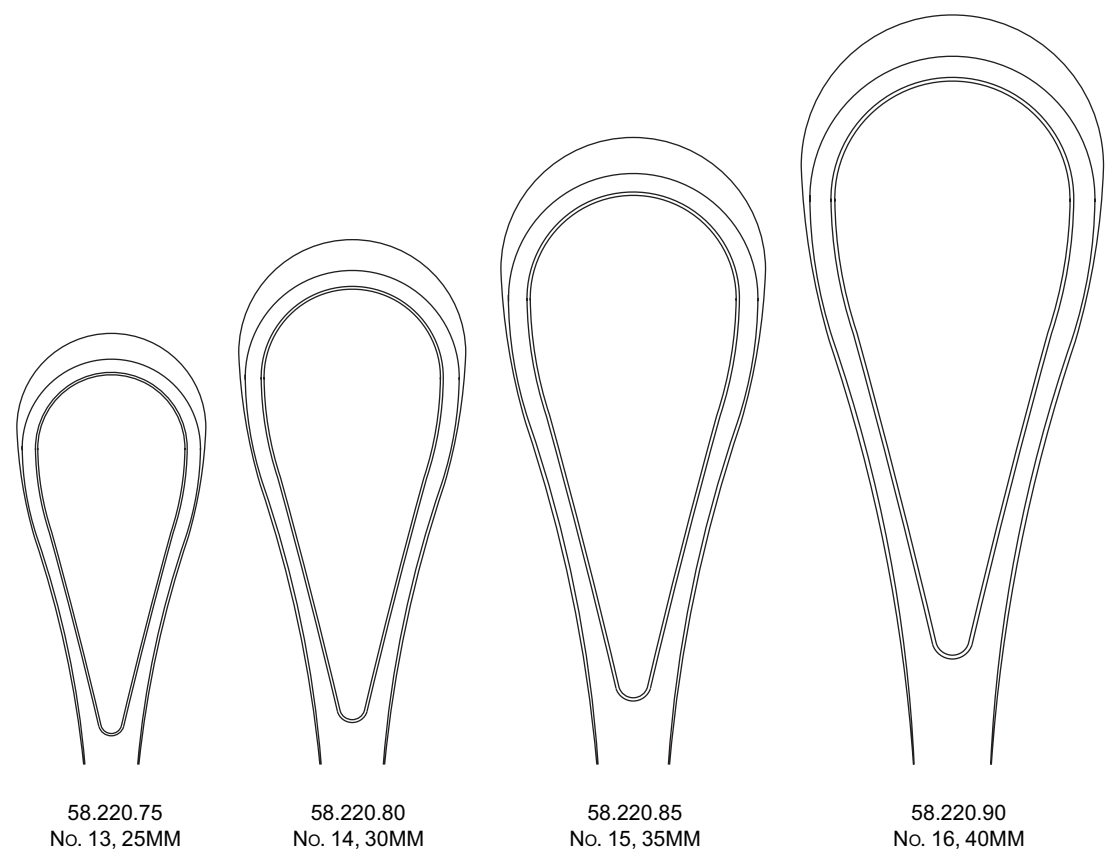
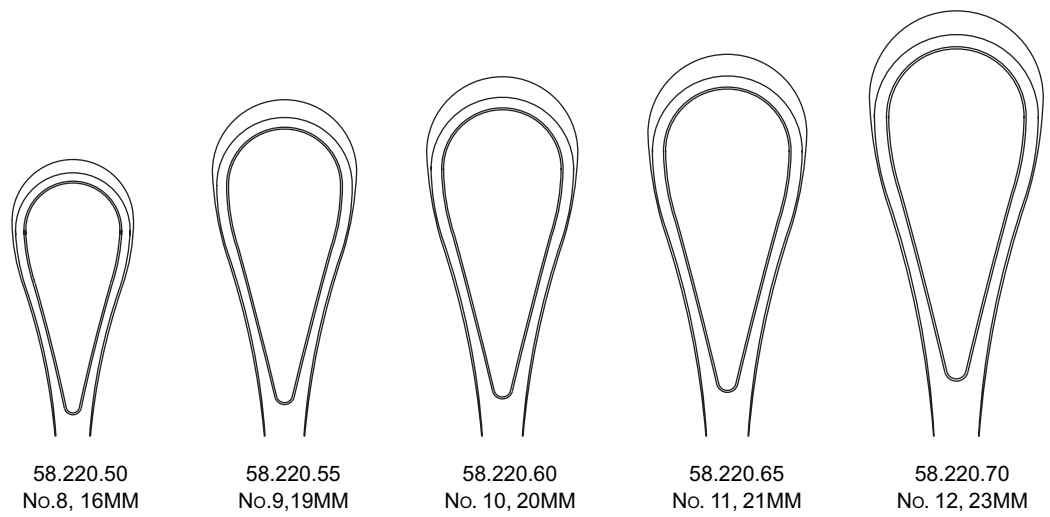
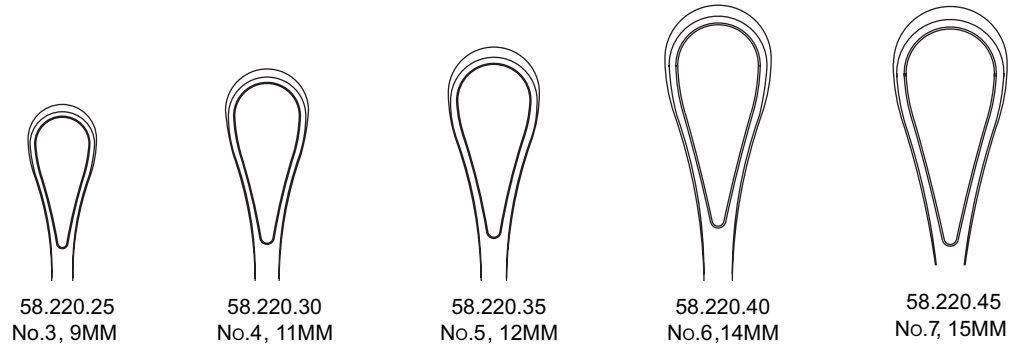
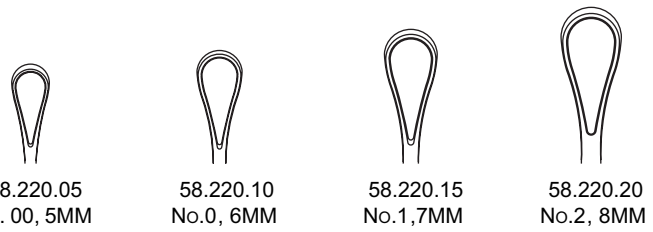

- 58.220.05 RECAMIER RIGID 00 5MM BLUNT 12.5" (32CM)
- 58.220.10 RECAMIER RIGID 0 6MM BLUNT 12.5" (32CM)
- 58.220.15 RECAMIER RIGID 1 7MM BLUNT 12.5" (32CM)
- 58.220.20 RECAMIER RIGID 2 8MM BLUNT 12.5" (32CM)
- 58.220.25 RECAMIER RIGID 3 9MM BLUNT 12.5" (32CM)
- 58.220.30 RECAMIER RIGID 4 11MM BLUNT 12.5" (32CM)
- 58.220.35 RECAMIER RIGID 5 12MM BLUNT 12.5" (32CM)
- 58.220.40 RECAMIER RIGID 6 14MM BLUNT 12.5" (32CM)
- 58.220.45 RECAMIER RIGID 7 15MM BLUNT 12.5" (32CM)
- 58.220.50 RECAMIER RIGID 8 16MM BLUNT 12.5" (32CM)
- 58.220.55 RECAMIER RIGID 9 19MM BLUNT 12.5" (32CM)
- 58.220.60 RECAMIER RIGID 10 20MM BLUNT 12.5" (32CM)
- 58.220.65 RECAMIER RIGID 11 21MM BLUNT 12.5" (32CM)
- 58.220.70 RECAMIER RIGID 12 23MM BLUNT 12.5" (32CM)
- 58.220.75 RECAMIER RIGID 13 25MM BLUNT 12.5" (32CM)
- 58.220.80 RECAMIER RIGID 14 30MM BLUNT 12.5" (32CM)
- 58.220.85 RECAMIER RIGID 15 35MM BLUNT 12.5" (32CM)
- 58.220.90 RECAMIER RIGID 16 40MM BLUNT 12.5" (32CM)

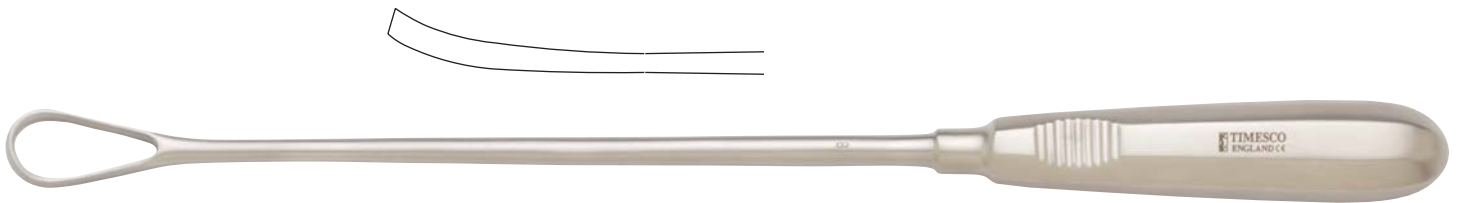

RECAMIER

- 58.225.05 RECAMIER MALLEABLE 00 5MM BLUNT 12.5" (32CM)
- 58.225.10 RECAMIER MALLEABLE 0 6MM BLUNT 12.5" (32CM)
- 58.225.15 RECAMIER MALLEABLE 1 7MM BLUNT 12.5" (32CM)
- 58.225.20 RECAMIER MALLEABLE 2 8MM BLUNT 12.5" (32CM)
- 58.225.25 RECAMIER MALLEABLE 3 9MM BLUNT 12.5" (32CM)
- 58.225.30 RECAMIER MALLEABLE 4 11MM BLUNT 12.5" (32CM)
- 58.225.35 RECAMIER MALLEABLE 5 12MM BLUNT 12.5" (32CM)
- 58.225.40 RECAMIER MALLEABLE 6 14MM BLUNT 12.5" (32CM)
- 58.225.45 RECAMIER MALLEABLE 7 15MM BLUNT 12.5" (32CM)
- 58.225.50 RECAMIER MALLEABLE 8 16MM BLUNT 12.5" (32CM)
- 58.225.55 RECAMIER MALLEABLE 9 19MM BLUNT 12.5" (32CM)
- 58.225.60 RECAMIER MALLEABLE 10 20MM BLUNT 12.5" (32CM)
- 58.225.65 RECAMIER MALLEABLE 11 21MM BLUNT 12.5" (32CM)
- 58.225.70 RECAMIER MALLEABLE 12 23MM BLUNT 12.5" (32CM)
- 58.225.75 RECAMIER MALLEABLE 13 25MM BLUNT 12.5" (32CM)
- 58.225.80 RECAMIER MALLEABLE 14 30MM BLUNT 12.5" (32CM)
- 58.225.85 RECAMIER MALLEABLE 15 35MM BLUNT 12.5" (32CM)
- 58.225.90 RECAMIER MALLEABLE 16 40MM BLUNT 12.5" (32CM)

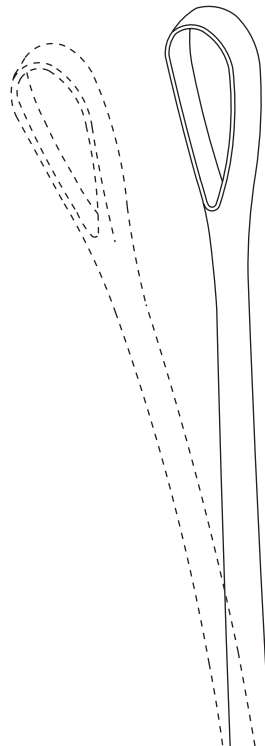

UTERINE CURETTES



58.310.10

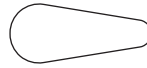

58.310.20

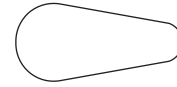

58.310.30

58.310.10 SIMS SINGLE ENDED SMALL $1/4$ " (6MM) SHARP 10" (25.5CM)

58.310.20 SIMS SINGLE ENDED MEDIUM $3/8$ " (9MM) SHARP 10" (25.5CM)

58.310.30 SIMS SINGLE ENDED LARGE $1/2$ " (12MM) SHARP 10" (25.5CM)



**SIMS
SINGLE ENDED SHARP**

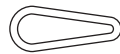

58.310.50

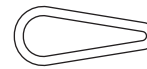

58.310.60

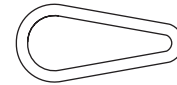

58.310.70

58.310.50 SIMS SINGLE ENDED SMALL $1/4$ " (6MM) BLUNT 10" (25.5CM)

58.310.60 SIMS SINGLE ENDED MEDIUM $3/8$ " (9MM) BLUNT 10" (25.5CM)

58.310.70 SIMS SINGLE ENDED LARGE $1/2$ " (12MM) BLUNT 10" (25.5CM)



**SIMS
SINGLE ENDED BLUNT**



58.315.10



58.315.20



58.315.30

58.315.10 SIMS DOUBLE ENDED SMALL ($1/4$ " X $3/16$ ") (6MM X 5MM) SHARP SHARP 10" (25.5CM)

58.315.20 SIMS DOUBLE ENDED MEDIUM ($3/8$ " X $1/4$ ") (9MM X 6MM) SHARP SHARP 10" (25.5CM)

58.315.30 SIMS DOUBLE ENDED LARGE ($1/2$ " X $3/8$ ") (12MM X 9MM) SHARP SHARP 10" (25.5CM)



**SIMS
DOUBLE ENDED SHARP SHARP**



58.315.50



58.315.60

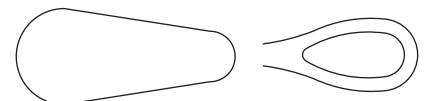

58.315.70

58.315.50 SIMS DOUBLE ENDED SMALL ($1/4$ " X $3/16$ ") (6MM X 5MM) SHARP BLUNT 10" (25.5MM)

58.315.60 SIMS DOUBLE ENDED MEDIUM ($3/8$ " X $1/4$ ") (9MM X 6MM) SHARP BLUNT 10" (25.5MM)

58.315.70 SIMS DOUBLE ENDED MEDIUM ($1/2$ " X $3/8$ ") (12MM X 9MM) SHARP BLUNT 10" (25.5MM)



**SIMS
DOUBLE ENDED SHARP BLUNT**

FLUSHING CURETTES

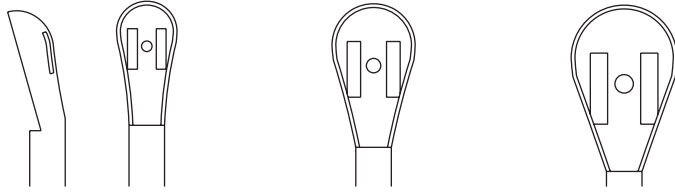

58.330.10

58.330.20

58.330.30

- 58.330.10 RHEINSTADTER SMALL 11.5" (29CM) 5/16" (8MM) SHARP
 58.330.20 RHEINSTADTER MEDIUM 11.5" (29CM) 7/16" (11MM) SHARP
 58.330.30 RHEINSTADTER LARGE 11.5" (29CM) 9/16" (14MM) SHARP

Curettes (flushing) such as Rheinstadter are cannulated and are used with suction to evacuate the uterine cavity. All cannulated curettes are supplied with cleaning stilletes.



RHEINSTADTER

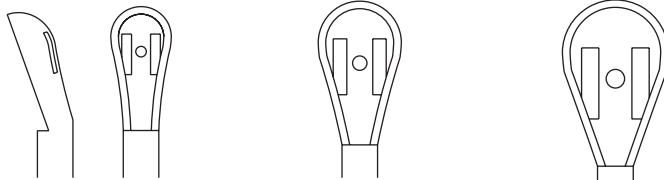

58.330.50

58.330.60

58.330.70

- 58.330.50 RHEINSTADTER SMALL 11.5" (29CM) 5/16" (8MM) BLUNT
 58.330.60 RHEINSTADTER MEDIUM 11.5" (29CM) 7/16" (11MM) BLUNT
 58.330.70 RHEINSTADTER LARGE 11.5" (29CM) 9/16" (14MM) BLUNT



RHEINSTADTER

BIOPSY CURETTES

○ 12FG 4mm

58.360.20 LEECH WILKINSON SUCTION 12FG 10" (25.5CM)



LEECH WILKINSON

BIOPSY CURETTES

Timesco's range of Endometrial curettes feature all the popular European and North American patterns, for sampling the Endometrial tissue.

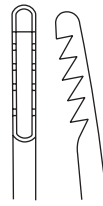

- 58.380.05
- 58.380.10
- 58.380.15
- 58.380.20

58.380.05 NOVAK SUCTION 1MM 10" (25.5CM)

58.380.10 NOVAK SUCTION 2MM 10" (25.5CM)

58.380.15 NOVAK SUCTION 3MM 10" (25.5CM)

58.380.20 NOVAK SUCTION 4MM 10" (25.5CM)



NOVAK

All the curettes feature rounded ends to avoid perforation of the uterus and sharp cutting retrograde teeth that take clean biopsies with ease. Cleaning stillettes are supplied with all cannulated curettes.



- 58.390.03
- 58.390.05
- 58.390.10

58.390.03 RANDALL SUCTION 2MM 10" (25.5CM)

58.390.05 RANDALL SUCTION 3MM 10" (25.5CM)

58.390.10 RANDALL SUCTION 4MM 10" (25.5CM)



RANDALL

○ 10FG 3.3mm



58.395.10 SHARMAN ENDOMETRIAL 10FG 9" (23CM) C/P



SHARMAN

DEPRESSORS

Timesco offers two standard depressors, Sims and Braun. These are used to apply pressure on the anterior cul-de-sac, exposing the OS. The Sims feature serrated non-sharp faces, which hold the walls without slipping.

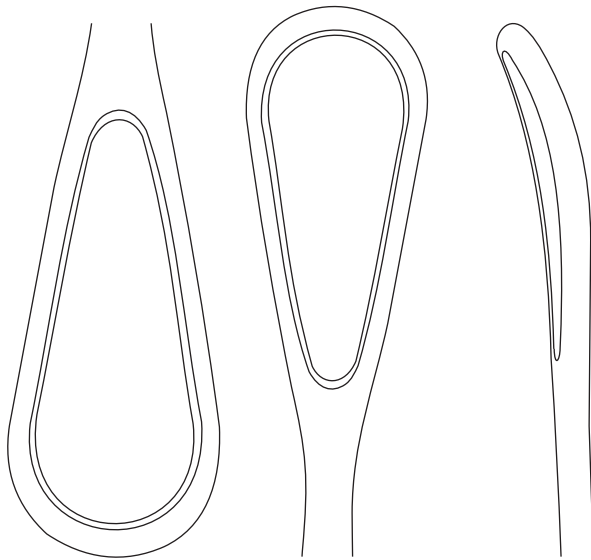

58.410.10 BRAUN UTERINE DOUBLE ENDED 11" (28CM)



BRAUN

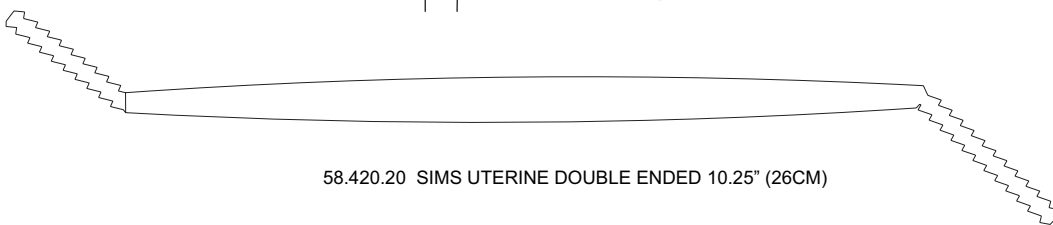
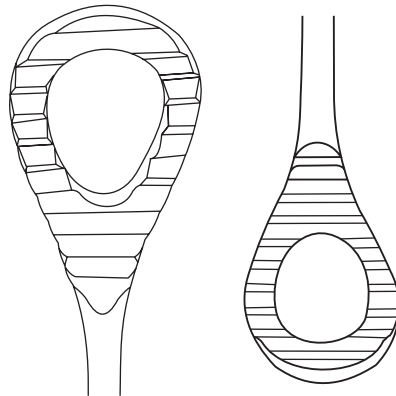

58.420.20 SIMS UTERINE DOUBLE ENDED 10.25" (26CM)



SIMS

UTERUS HOLDING FORCEPS

These forceps are designed to hold the complete uterus in their jaws without rupturing the sac, especially during operations for prolapse.

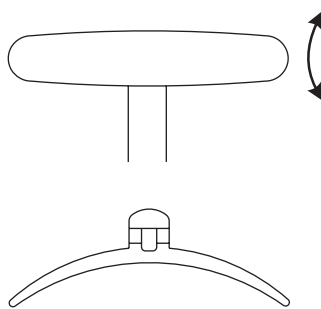

58.430.10 COLLIN UTERINE 10" (25.5CM) SCREW JOINT
(Also known as 'Shirodkar')



COLLIN

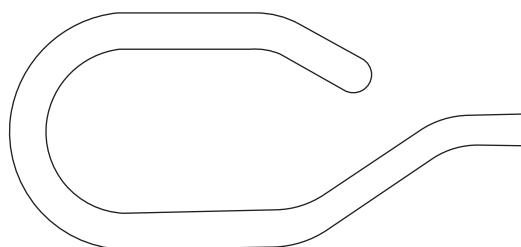

58.440.20 DARTIGUE 10.5" (27CM) SCREW JOINT



DARTIGUE

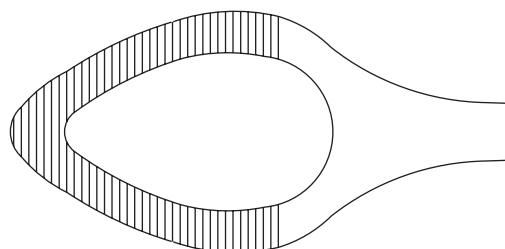

58.460.20 SOMER FORCEP 10" (25.5CM) SCREW JOINT



SOMER

HYSTERECTOMY CLAMPS

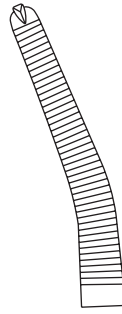

58.480.20 BONNEY ANGLED 8° (20CM) 1 X 2TH SCREW JOINT



BONNEY

Hysterectomy clamps are heavier, powerful versions of haemostatic forceps and are referred to as 'clamps'. These feature thick strong jaws and shanks. Due to the nature of their use, their jaws are serrated mainly longitudinally to hold and occlude, without slipping.

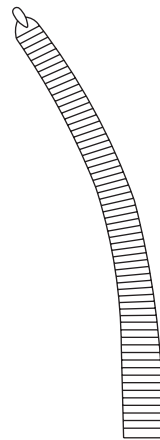

58.485.20 BONNEY-BERKELY CURVED 8° (20CM) 1 X 2TH SCREW JOINT



BONNEY-BERKELY

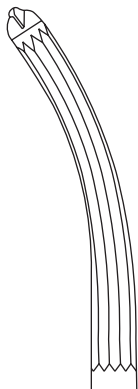
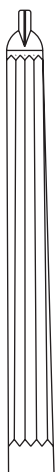

58.515.20 GWILLIAM STRAIGHT 8° (20CM) BOX JOINT

58.515.40 GWILLIAM CURVED 8° (20CM) BOX JOINT



GWILLIAM

Many varieties of the Hysterectomy forceps are available. Timesco also manufacture the Timesco Parametrium forceps, which features special non-slip grooves and powerful jaws, which are precision made to prevent slipping and trauma.

HYSTERECTOMY CLAMPS

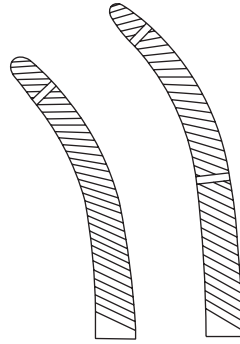

58.520.20 HEANEY CURVED 8" (20CM) 1-TOOTH BOX JOINT

58.520.40 HEANEY CURVED 8" (20CM) 2-TEETH BOX JOINT



HEANEY



58.540.20 HUNTER CURVED 9"(23CM) BOX JOINT



HUNTER

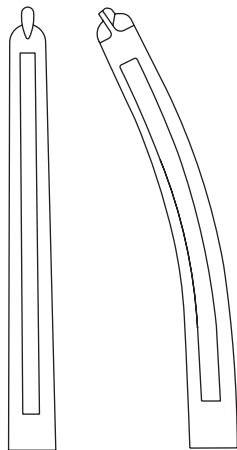

58.550.20 MAINGOT STRAIGHT 8" (20CM) BOX JOINT

58.550.40 MAINGOT CURVED 8" (20CM) BOX JOINT



MAINGOT

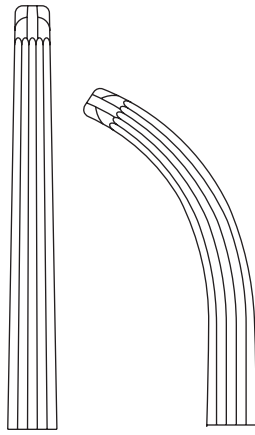

58.555.20 McCULLAGH STRAIGHT 8.75" (22CM) BOX JOINT

58.555.40 McCULLAGH CURVED 8.75" (22CM) BOX JOINT

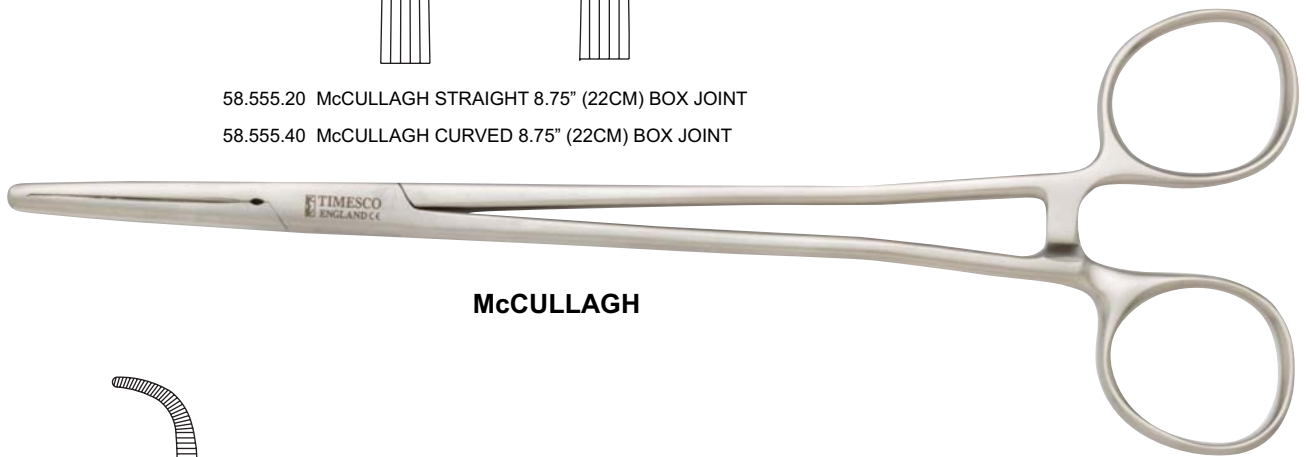

McCULLAGH

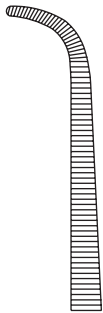

58.565.10 NAVRATILL VAGINAL CURVED 9" (23CM) BOX JOINT

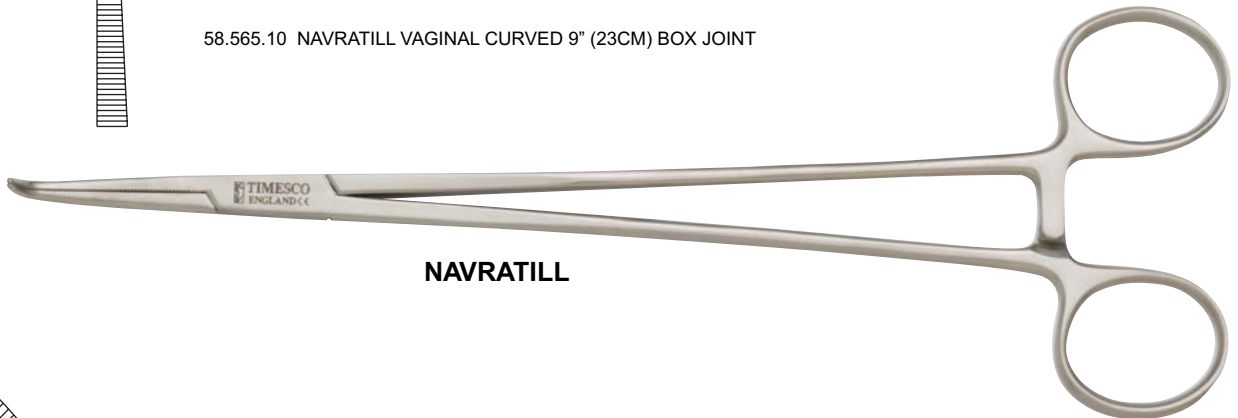

NAVRATILL

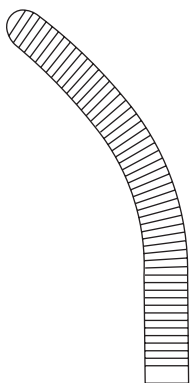

58.760.10 WERTHEIM PARAMETRIUM CURVED 10" (25.5CM) BOX JOINT

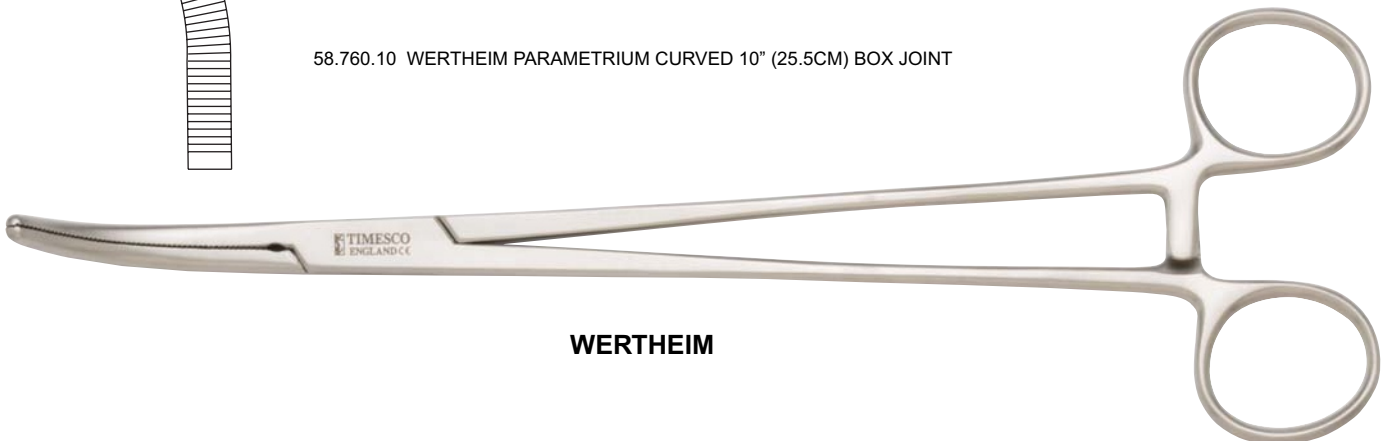

WERTHEIM

HYSTERECTOMY CLAMPS

These feature 'Debakey' type non-traumatic jaws which hold without crushing.

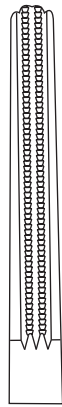

58.575.20

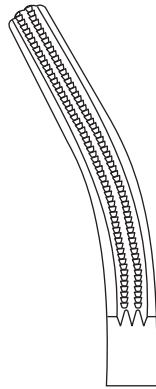

58.575.40

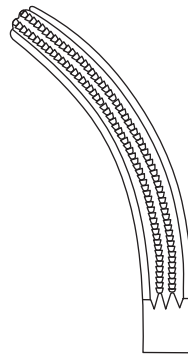

58.575.60

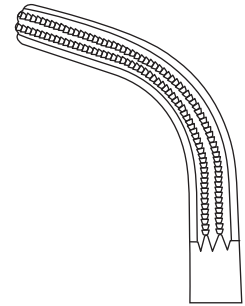

58.575.80

58.575.20 TIMESCO PARAMETRIUM STRAIGHT NO:1 8.75" (22CM)

58.575.40 TIMESCO PARAMETRIUM SLIGHTLY CURVED NO:2 8.75" (22CM)

58.575.60 TIMESCO PARAMETRIUM MEDIUM CURVED NO:3 8.75" (22CM)

58.575.80 TIMESCO PARAMETRIUM FULL CURVED NO:4 8.75" (22CM)



TIMESCO PARAMETRIUM

INSUFFLATION CANNULAS

○ 12FG 4mm 58.655.20 CURRIE RUBBER CONE 14" (35.5CM) 12 FG WITH STOPCOCK



CURRIE

From the 'screw' tip type, Leech Wilkinson, to the stopcock type, Curries, Timesco offers a complete range of cannulas for insuffulation of the Uterus.

○ 10FG 3.33mm 58.660.20 HAYES - PROVIS 10" (25.5CM) 10FG



HAYES - PROVIS

INSUFFLATION CANNULAS

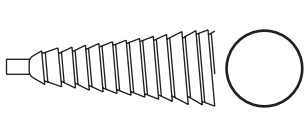

58.665.10 10mm

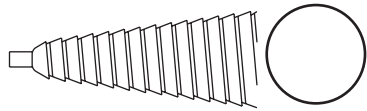

58.665.20 13mm

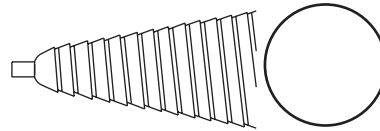

58.665.30 16mm

- 58.665.10 LEECH WILKINSON SMALL 10" (25.5CM) C/P
- 58.665.20 LEECH WILKINSON MEDIUM 10" (25.5CM) C/P
- 58.665.30 LEECH WILKINSON LARGE 10" (25.5CM) C/P

Some cannulas, eg. Spackman cannula have a travelling bar into which a Vulsellum forceps can be hooked to station the cannula in the cervix.



LEECH WILKINSON

○ 10FG 3.33mm

58.670.20 PROVIS RUBBER CONE 8" (20CM) 10FG



PROVIS

○ 10FG 3.33mm

58.675.40 PROVIS METAL CONE 7.75" (19.5CM) 10FG



PROVIS

Timesco cannulas are available with metal, or latex free autoclavable rubber 'acorns'. All cannulas are supplied with a cleaning stillette.

○ 12FG 4mm

58.680.10 SPACKMAN RUBBER CONE 14.75" (37.5CM) 12FG



SPACKMAN

○ 12FG 4mm

58.690.20 SPACKMAN METAL CONE 14.75" (37.5CM) 12FG

○ 18FG 6mm

58.690.30 SPACKMAN METAL CONE 14.75" (37.5CM) 18FG



SPACKMAN



SPACKMAN RUBBER ONLY

This is a universal size and can be used on all Cannulas with 10FG and 12FG sizes.

58.685.10 SPACKMAN RUBBER ONLY 'ACORN'

MYOMA CREWS

The Doyen Myoma screws are designed to remove fibroids (myomas). After an initial incision is made in the uterine wall to expose the fibroid, the myoma screw is screwed into it, and pulled to enucleate the growth.

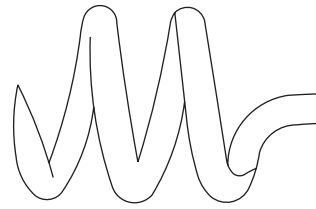

58.725.10 DOYEN FOR ABDOMEN 7" (18CM) (LARGE)



DOYEN MYOMA

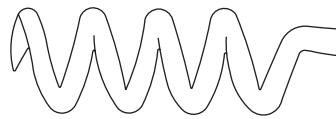

58.725.20 DOYEN FOR VAGINA 7" (18CM) (SMALL)



DOYEN MYOMA

MYOMECTOMY CLAMPS

Like its Hysterectomy clamp namesake, this clamp was principally designed for use in Myomectomy procedures. The clamp is applied from the front to the lower

58.730.10 BONNEY 10.5" (27CM) SCREW JOINT

segment of the uterus to include the round ligaments and to compress the uterine vessels.



BONNEY



58.770.10 BONNEY 9.5" (24CM) BOX JOINT

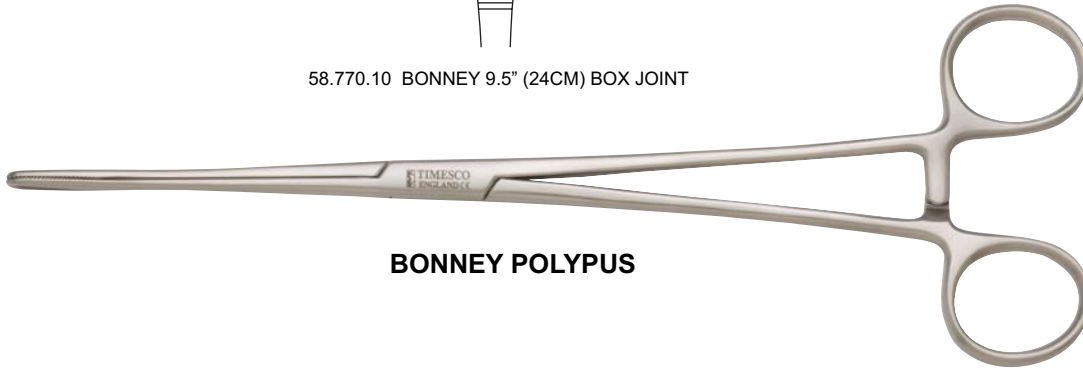

BONNEY POLYPUS

The Bonney Polypus forceps are a very popular instrument, which are also referred to as a 'Ring Forcep'. Due to its narrow jaw, it can be passed through a narrowly dilated cervix to remove Polyps from the uterus or cervical canal.

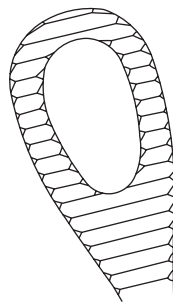

58.795.10 KELLY 12.5" (32CM) BOX JOINT

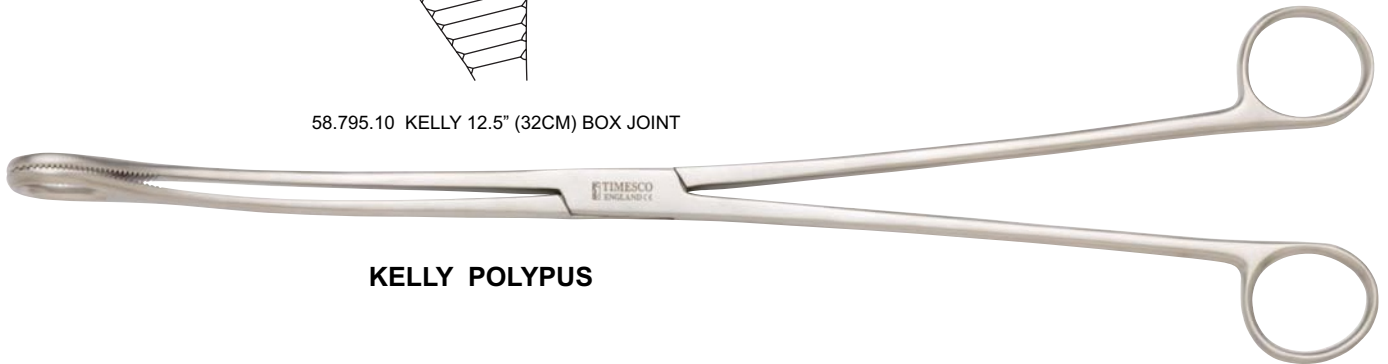

KELLY POLYPUS

Polypus forceps are so named for removing 'Polyps' from the uterus.

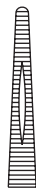

58.799.50S TIMESCO 10.5" (27CM) NARROW SCREW JOINT

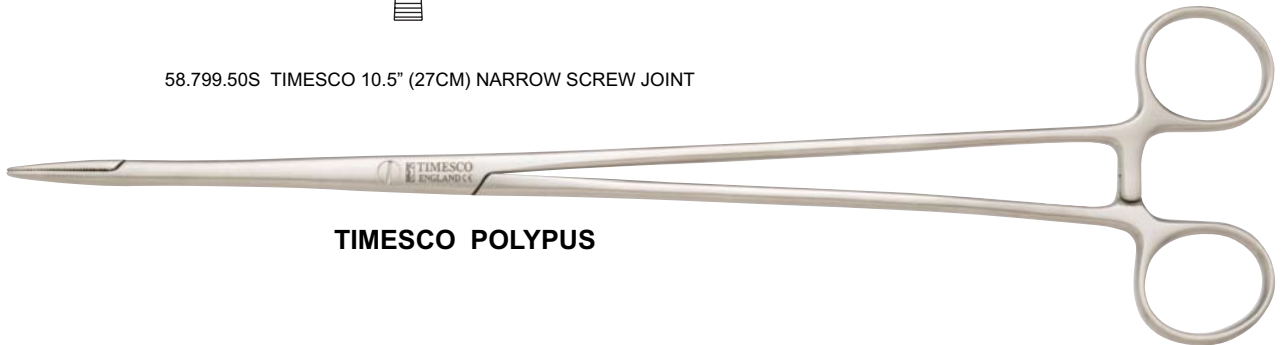

TIMESCO POLYPUS

The larger jawed patterns (eg. Kelly) are also used as general purpose instruments in Gynaecological procedures.

This forcep is also useful due to its narrow, elongated jaw in IUCD procedures.

UTERINE SOUNDS

Timesco uterine sounds are made especially from quality copper rod, which is then electroplated in silver. The copper rod is graduated and allows malleability so that the sounds can be shaped to the shape of the uterus.

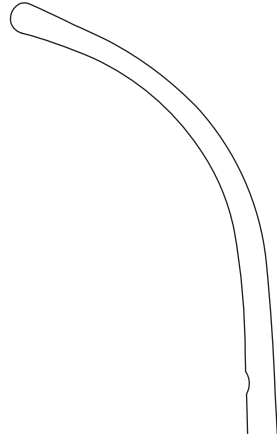

58.815.20 GALABIN 12" (30.5CM) TIP 4MM, S/P



GALABIN

The tips of the sounds are rounded to prevent perforation of the uterus walls.

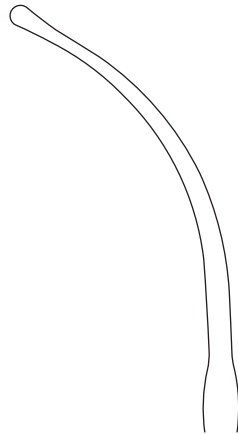

58.820.20 HORROCK 11" (28CM) TIP 3MM, S/P



HORROCK

The sounds are graduated in cm to measure the depth of insertion into the uterine cavity.

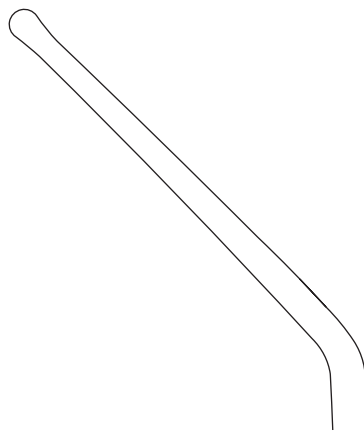

58.830.20 SIMPSON 12" (30.5CM) TIP 4MM, S/P



SIMPSON

UTERINE SOUNDS

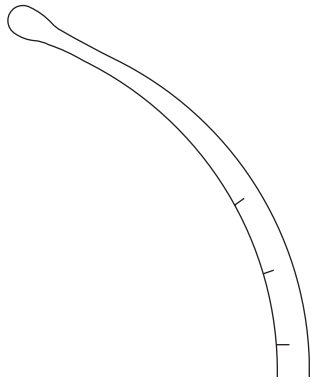

58.840.20 SIMS 12.5" (32CM) TIP 4MM, S/P



SIMS

IUCD UTERINE HOOKS

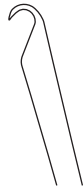

58.870.20 GRAFENBERG HOOK 5MM 12.5" (32CM)

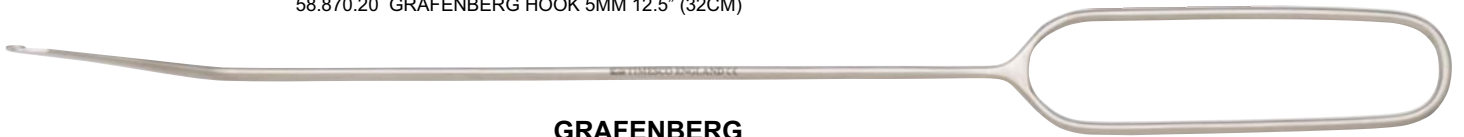

GRAFENBERG

IUCD REMOVAL FORCEPS

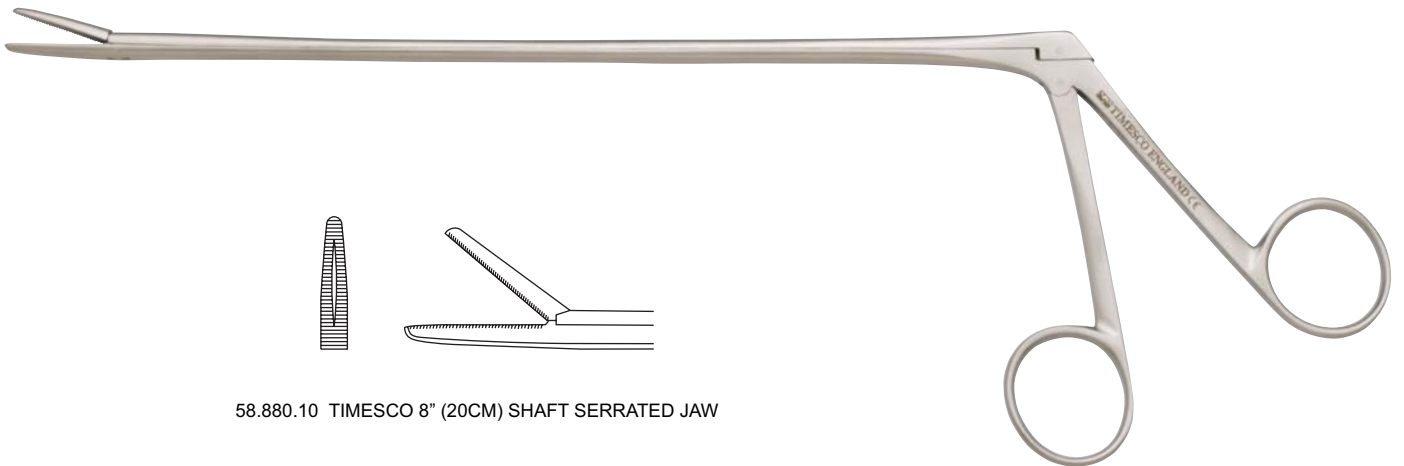

58.880.10 TIMESCO 8" (20CM) SHAFT SERRATED JAW

Timesco produce the classic crocodile action IUCD removing forceps, which is referred to as the WHO (World Health Organisation) type. Also much simpler inexpensive hook type thread/coil removers are available such as the Grafenberg hook.

CAESAREAN SECTION FORCEPS

The Green Armytage forceps are classic Haemostatic forceps, which are used, in lower segment of caesarean sections.

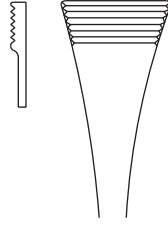

61.100.20 GREEN-ARMYTAGE STRAIGHT 8" (20CM) SCREW JOINT

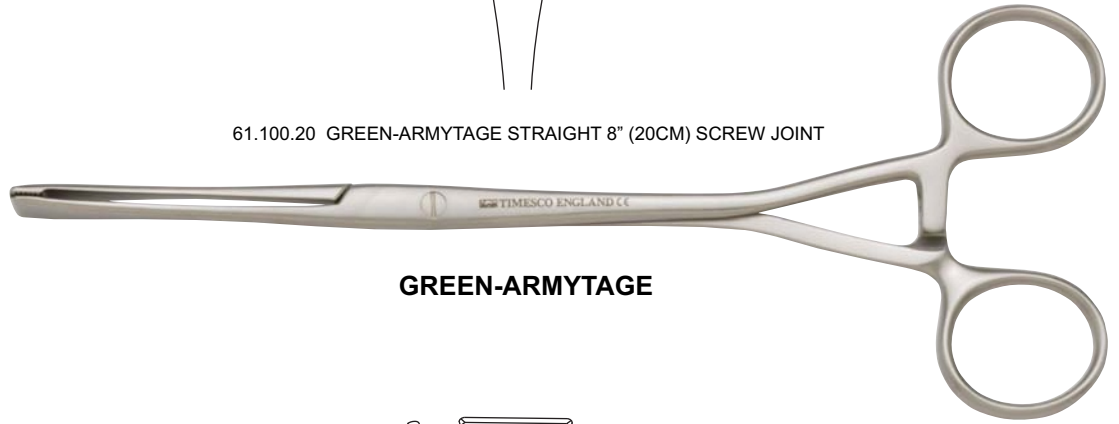

GREEN-ARMYTAGE

The jaws feature large serrated faces, which occlude the sinuses without trauma or crushing.

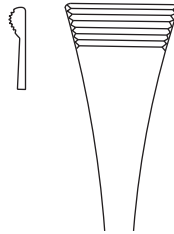

61.100.30 GREEN-ARMYTAGE ANGLED 7.75" (19.5CM) SCREW JOINT

The original design was subsequently modified and is available in angled form also.



GREEN-ARMYTAGE

INDUCTION CATHETERS

The Drew Smyth catheter ruptures the membranes of the amniotic sac. In particular it was designed to puncture the hind waters and to evacuate the amniotic fluid.

61.115.20 DREW SMYTHE 8EG 13.75" (35CM) S/P



DREW SMYTHE

CRANIO AND CEPHALO

61.125.10 BRAUN CRANIOCLAST 16.5" (35CM)



BRAUN

61.150.10 WINTER CRANIOCLAST + CEPHALOTRIBE 16.5" (35CM)

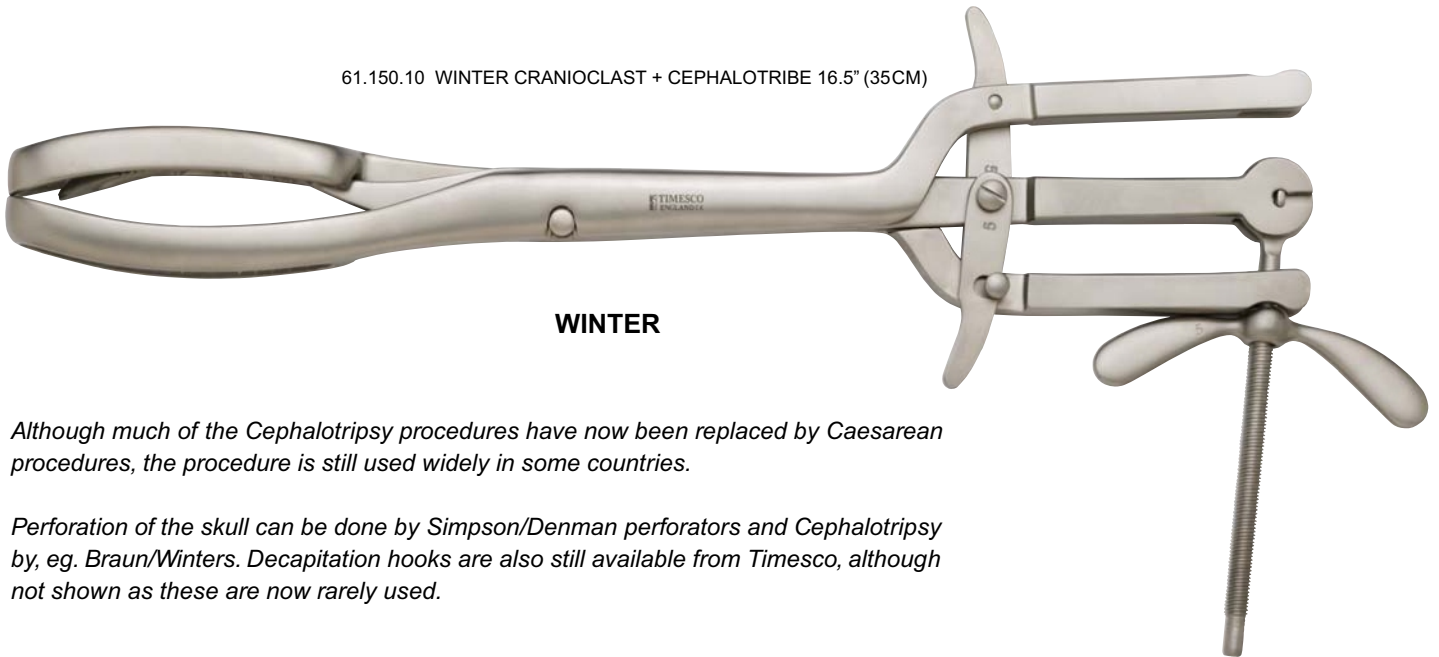





WINTER

Although much of the Cephalotripsy procedures have now been replaced by Caesarean procedures, the procedure is still used widely in some countries.

Perforation of the skull can be done by Simpson/Denman perforators and Cephalotripsy by, eg. Braun/Winters. Decapitation hooks are also still available from Timesco, although not shown as these are now rarely used.

UTERUS EVACUATION / ASPIRATION CURETTES

- 61.160.10 
- 61.160.20 
- 61.160.30 
- 61.160.40 
- 61.160.50 

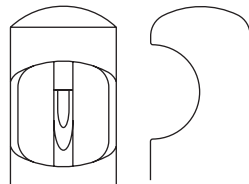

- 61.160.10 BIERER ASPIRATION CURETTE 11" (28CM) 8MM
- 61.160.20 BIERER ASPIRATION CURETTE 11" (28CM) 10MM
- 61.160.30 BIERER ASPIRATION CURETTE 11" (28CM) 12MM
- 61.160.40 BIERER ASPIRATION CURETTE 11" (28CM) 14MM
- 61.160.50 BIERER ASPIRATION CURETTE 11" (28CM) 16MM

These uniquely designed curettes are all metal construction, have rounded ends to prevent perforation of the uterus, and length markings to indicate depth of introduction. The double tube manufacture prevents clogging/obstruction.



BIERER

The curettes are supplied complete with rotating connectors for attaching to suction pumps. The illustration shows the connector attached to the Curette handle. Length stated is without the connector.

INDUCTION FORCEPS

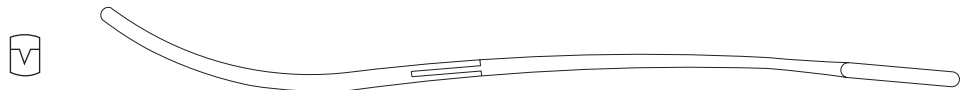

61.300.10 GOODWIN AMNIOTOMY FORCEP 10.25" (26 CM) BOX JOINT



GOODWIN

OBSTETRIC FORCEPS

61.340.10 ANDERSON MIDWIFERY FORCEPS 15" (38CM)



ANDERSON

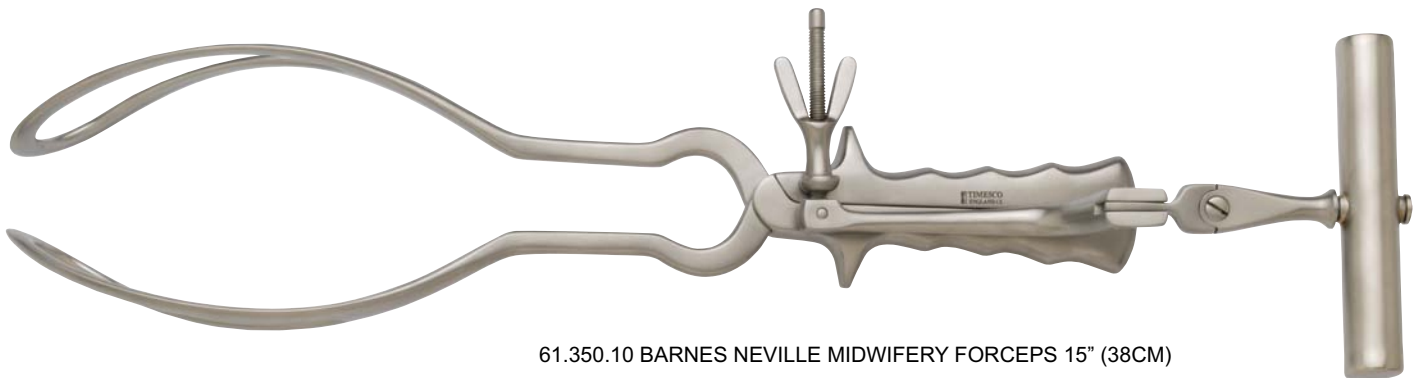

61.350.10 BARNES NEVILLE MIDWIFERY FORCEPS 15" (38CM)

BARNES NEVILLE
with Axis Traction



61.360.20 DE LEE MIDWIFERY FORCEP 12" (30.5CM)

DE LEE

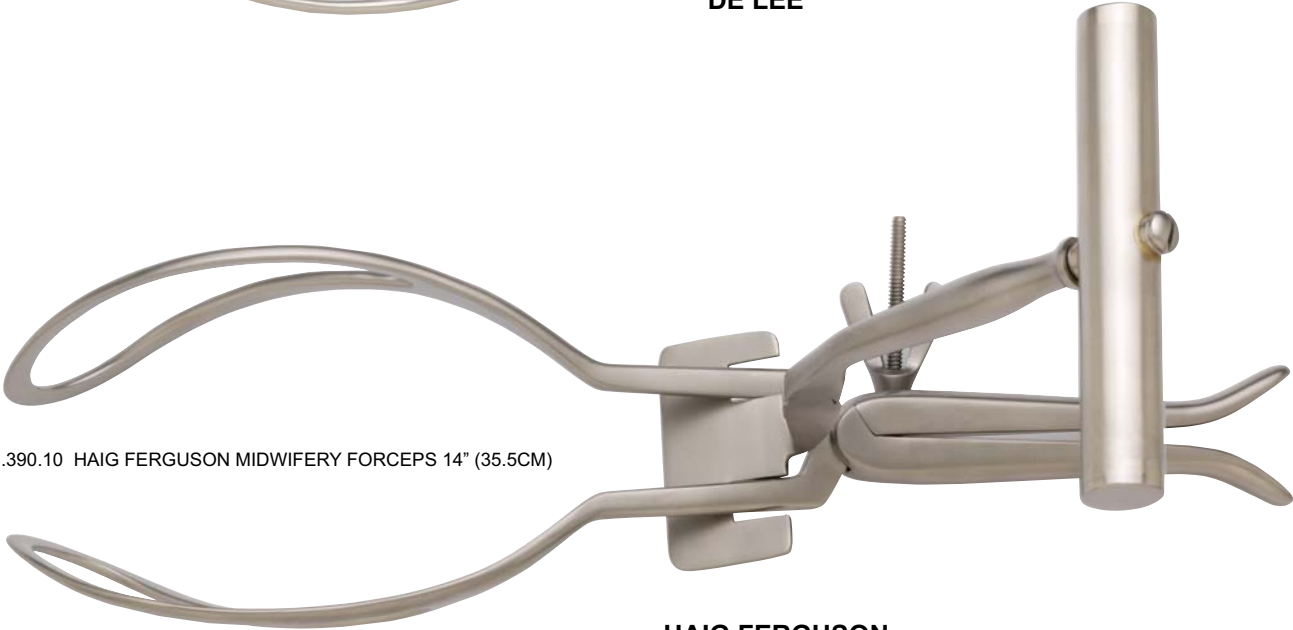

61.390.10 HAIG FERGUSON MIDWIFERY FORCEPS 14" (35.5CM)

HAIG FERGUSON
with Axis Traction



61.420.10 KIELLAND MIDWIFERY FORCEPS 16" (40.5CM)

KIELLAND



61.430.20 KIELLAND LUIKART MIDWIFERY FORCEPS 15.5" (39.5CM)

KIELLAND LUIKART

1

OBSTETRIC FORCEPS

61.480.10 MILNE MURRAY MIDWIFERY FORCEP 13" (33CM)

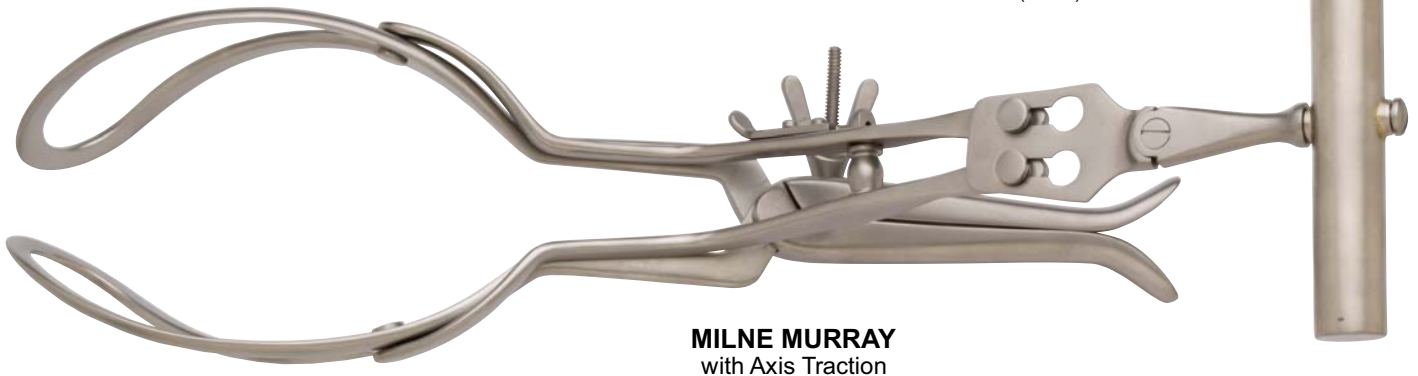

61.520.20 SIMPSON MIDWIFERY FORCEPS 11" (28CM)

61.520.40 SIMPSON MIDWIFERY FORCEPS 15" (38CM)



61.550.10 TARNIER MIDWIFERY FORCEPS 15.75" (40CM)



61.560.10 WRIGLEY MIDWIFERY FORCEP 11" (28CM)



MUCOUS EVACUATORS

61.580.10 CARTON MUCOUS EVACUATOR 9" (23CM)



CARTON
(Also known as 'Marshall Cowell')

OVUM / PLACENTA FORCEPS

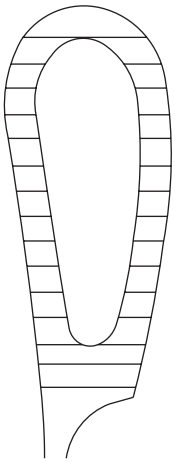

61.600.10 BIERER OVUM FORCEPS 11" (28CM) SCREW JOINT



BIERER

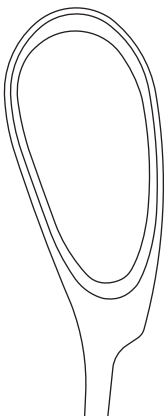

61.610.10 GREENHALGH OVUM FORCEPS 9.5" (24CM) SCREW JOINT



GREENHALGH

OVUM / PLACENTA FORCEPS

Ovum forceps are forceps which are also referred to as 'Placenta' forceps. These forceps feature large jaws, some with 'cups' for holding the ovaries, and are used to hold placenta, ovum and any excised tissue from the uterus.

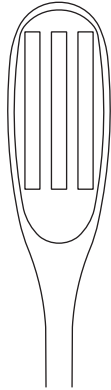

61.620.10 HEYWOOD SMITH OVUM FORCEPS 10.5" (27CM) SCREW JOINT



HEYWOOD SMITH

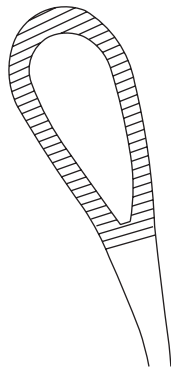

61.640.10 McLINTOCK OVUM FORCEPS CURVED 9.5" (24CM) SCREW JOINT



McLINTOCK

As its name suggests the Willett forceps are designed especially for holding the afterbirth.

The jaws feature serrations and two sharp conical pins, which securely hold without slipping.

These forceps due to their strong non-slip action are also used extensively in cranial surgery to hold the skull flap.

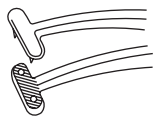

Not to scale

61.780.10 WILLETT PLACENTA FORCEP 7.5" (19CM) SCREW JOINT



WILLETT

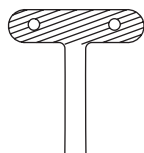



61.680.10 BREISKY 13" (33CM)

BREISKY

We have illustrated two of the most popular pelvimeters, which are still currently used, Martin and Briesky.

Pelvimeters are Calipers used to measure the size of the abdomen, ie. estimate the size of the child, and are precision graduated with a scale in MM/CM.

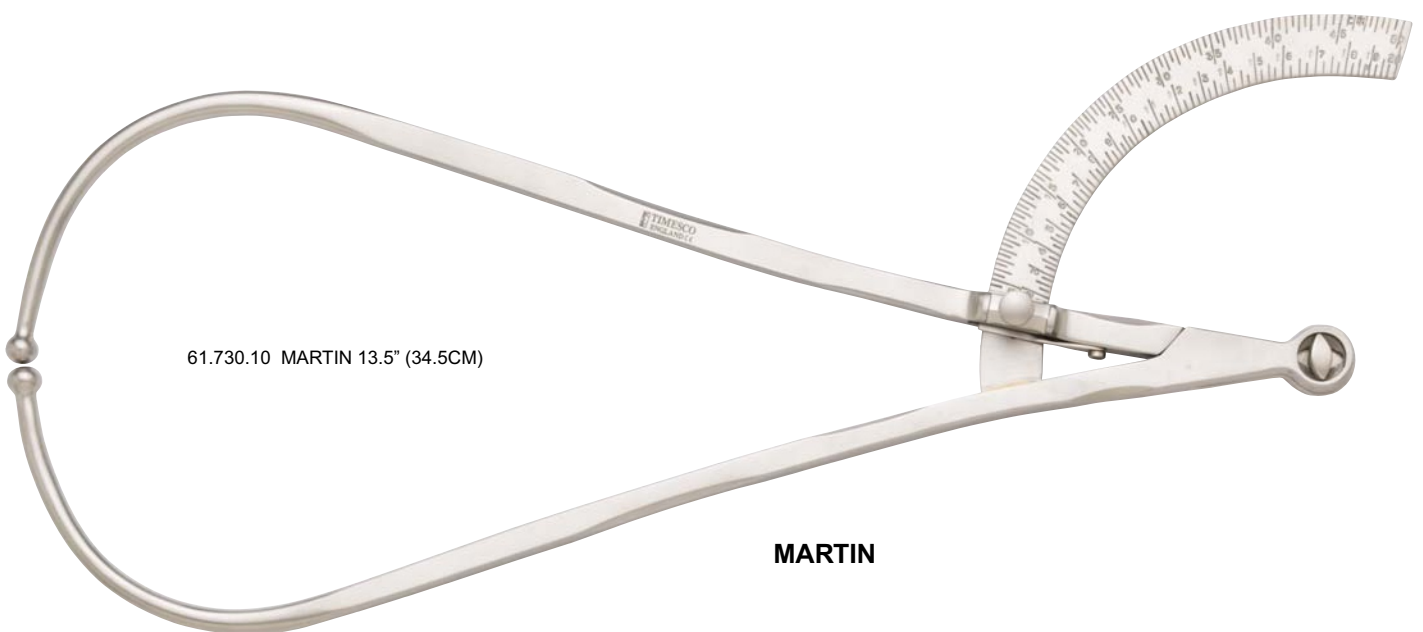

61.730.10 MARTIN 13.5" (34.5CM)

MARTIN

PERFORATORS

61.760.10 DENMAN 10" (25.5CM) SCREW JOINT



DENMAN

61.770.10 SIMPSON 11.25" (28.5CM) SCREW JOINT



SIMPSON

UMBILICAL DILATORS

61.810.10 UMBILICAL 3.75" (9.5CM)

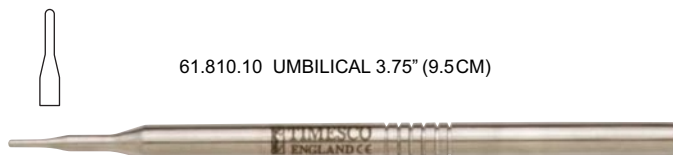

STETHOSCOPES



















03.350.10 PINARD STETHOSCOPES 5" (13CM) PLASTIC BLACK



03.360.20 PINARD STETHOSCOPES 6" (15CM) ALUMINIUM

COMPARISON TABLE OF DIAMETERS AND GAUGES

DIAMETERS MM	FRENCH GAUGE (FG)	ENGLISH GAUGE (EG)	DIAMETERS MM	FRENCH GAUGE (FG)	ENGLISH GAUGE (EG)
0.33 .	1	-	9.00 	27	16
0.50 •	-	00	9.33 	28	-
0.66 •	2	-	9.50 	-	17
1.00 ◦	3	0	9.66 	29	-
1.33 ◦	4	-	10.00 	30	18
1.50 ◦	-	1	10.33 	31	-
1.66 ◦	5	-	10.50 	-	19
2.00 ◦	6	2	10.66 	32	-
2.33 ◦	7	-	11.00 	33	20
2.50 ◦	-	3	11.33 	34	-
2.67 ◦	8	-	11.50 	-	21
3.00 ◦	9	4	11.66 	35	-
3.33 ◦	10	-	12.00 	36	22
3.50 ◦	-	5	12.33 	37	-
3.66 ◦	11	-	12.50 	-	23
4.00 ◦	12	6	12.66 	38	-
4.33 ◦	13	-	13.00 	39	24
4.50 ◦	-	7			
4.66 ◦	14	-			
5.00 ◦	15	8			
5.33 ◦	16	-			
5.50 ◦	-	9			
5.66 ◦	17	-			
6.00 ◦	18	10			
6.33 ◦	19	-			
6.50 ◦	-	11			
6.66 ◦	20	-			
7.00 ◦	21	12			
7.33 ◦	22	-			
7.50 ◦	-	13			
7.66 ◦	23	-			
8.00 ◦	24	14			
8.33 ◦	25	-			
8.50 ◦	-	15			
8.66 ◦	26	-			

Timesco is internationally recognised as one of the leading producers and suppliers of theatre quality (OR) surgical instruments and medical products. We produce products covering a vast spectrum of surgical and medical applications. Please contact your local Timesco Territory Manager or your local Timesco Distributor for details of our full range or visit our website.



SURGICAL

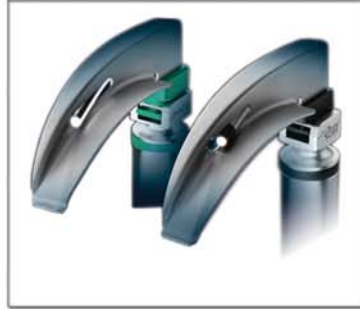

LARYNGOSCOPY



DIAGNOSTIC



GYNAECOLOGY



ENT



DENTAL

TIMESCO
INSTRUMENTS FOR LIFE

Timesco Healthcare Ltd.

3 Carnival Park, Carnival Close, Basildon, Essex SS14 3WN, England
T: +44 (0) 1268 297 700 F: +44 (0) 1268 297 800 E: export@timesco.com
W: www.timesco.com

E & O.E. Copyright May 2015. Ref C.G.001/2

'Timesco' and 'Instruments for Life' are registered trademarks of Timesco Healthcare Ltd. All rights reserved.